

ASA DENTAL



CATALOGO DENTALE 2025

INDICE

CATALOGO 2025

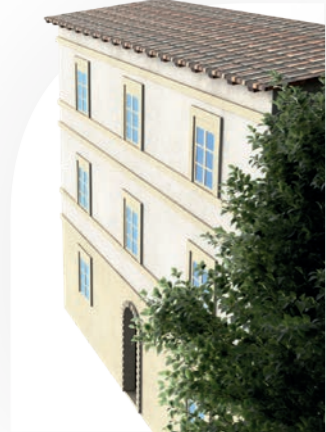

01-12
L'AZIENDA



13-00
INDICE DEI NOMI
SCIENTIFICI



A01-A19
ASAONE



B01-B25
DIAGNOSTICA



C01-C47
CHIRURGIA ORALE



D01-D73
CHIRURGIA ESTRATTIVA



E01-E41
CHIRURGIA IMPLANTARE



F01-F53
CONSERVATIVA



G01-L19
ENDODONZIA



H01-G37
PARODONTOLOGIA



I01-H37
ORTODONZIA

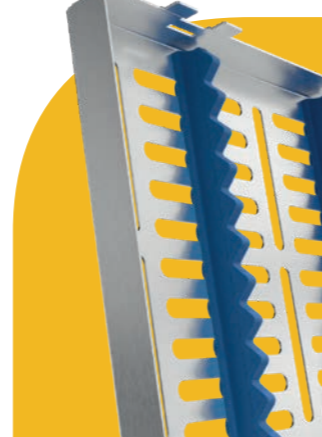

J01-I17
VASSOI E CONTENITORI



K01-J49
PORTAIMPRONTA



L01-K35
STRUMENTI PER
LABORATORIO



00-00
INDICE DEI CODICI



00-00
INDICE DEI PRODOTTI

1961



FONDAZIONE

L'intuizione di Aldo Puccetti diventa realtà imprenditoriale. Nasce Asa Dental.

1965

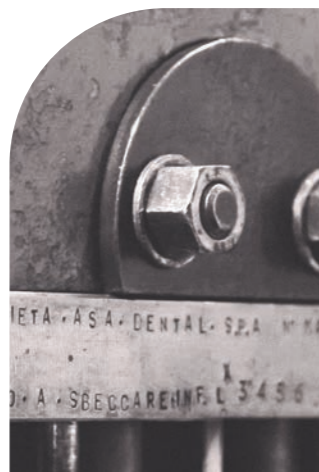

MANIAGO

Viene inaugurato lo stabilimento di Maniago. La produzione di strumenti in acciaio affianca quella di prodotti monouso, a completamento dell'offerta aziendale.

1975



MARLIA

Inizia la produzione nello stabilimento di Marlia per soddisfare la crescente richiesta da parte dai mercati.

2001



DERBY DENTAL

Asa Dental acquisisce Derby Dental e aggiunge nuovi prodotti alla propria offerta.

2004

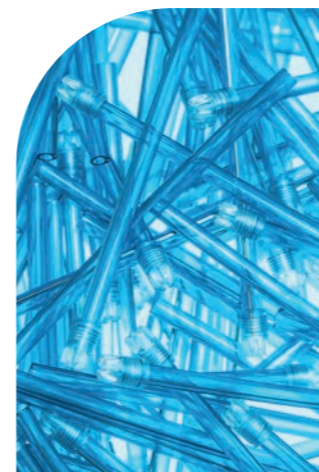

KALTOPLAST

Con l'acquisizione di Kaltoplast, Asa Dental consolida la posizione di leader nel segmento di aspirasaliva monouso.

2009



ALESSANDRO MALFATTI

Dal presente al futuro: Alessandro Malfatti diventa il nuovo General Manager.

2010



ASA DENTAL USA

L'azienda rafforza la propria posizione internazionale con l'apertura della filiale negli Stati Uniti.

2012



ASAONE

Investimenti a supporto dell'efficienza produttiva e operativa incrementano la competitività dei prodotti monouso.

2013



ASA DENTAL CINA

Diventa operativa la filiale cinese del gruppo con l'obiettivo di servire uno dei mercati più importanti per dimensioni e velocità di crescita.

2014



MANIAGO

Gli stabilimenti di Maniago incrementano la capacità produttiva e migliorano la qualità degli strumenti in acciaio inossidabile.

2015



BOZZANO

Inaugurazione del magazzino verticale automatizzato grazie al quale il nuovo centro di logistica migliora l'efficienza e riduce i tempi di consegna in tutto il mondo.

2016



EDUCATIONAL CENTER

Nasce l'Educational Center con lo scopo di collegare opinion leaders, università e professionisti.

2018



DUBAI

Asa Dental inaugura la filiale di Dubai e consolida le attività a supporto di tutta l'area mediorientale.

2019



DIGITAL INTEGRATION

La tecnologia digitale collega progettazione, sviluppo e comunicazione di prodotto in modo semplice e intuitivo.

2023



SOSTENIBILITÀ

Nuovo impianto fotovoltaico al Centro Logistico di Bozzano.

NETWORK MONDIALE

La missione aziendale di aiutare le persone a sorridere, ovunque nel mondo, implica vivere a stretto contatto con i professionisti del settore, comprendere le differenze tra i vari mercati e progettare prodotti e servizi su misura per ogni dentista, odontotecnico e assistente.

Grazie a una presenza internazionale strutturata, con filiali negli Stati Uniti, in Cina e negli Emirati Arabi, Asa Dental può operare con la massima efficienza su scala globale e allo stesso tempo rispettare le diverse esigenze di ogni singolo mercato. La sede centrale italiana coordina la produzione, la vendita e la logistica combinando innovazione e tradizione attraverso la progettazione creativa e la produzione esperta, gli ingredienti per la ricetta autentica del moderno del Made in Italy.

Il nostro impegno è ripagato dalla consapevolezza che, con i nostri prodotti, i professionisti del settore possono migliorare la qualità di vita di milioni di pazienti in oltre 170 paesi, aiutandoci a tener fede alla nostra missione e rendendo la pratica dentale accessibile a chiunque.



A. ITALIA



B. STATI UNITI



C. CINA



D. EMIRATI ARABI

INNOVAZIONE E TRADIZIONE

Asa Dental ha da sempre dedicato gran parte delle sue risorse alla produzione dei propri dispositivi.

Invertendo il trend mondiale di delocalizzazione produttiva, abbiamo scelto di concentrare in Italia l'intera produzione aziendale, in modo da garantire ai nostri clienti un eccellente livello qualitativo.

Il controllo rigoroso dell'intero processo produttivo, sia per i prodotti monouso che per gli strumenti in acciaio, ha permesso di migliorare costantemente la qualità e l'efficienza operativa.

Ciascun sito produttivo è specializzato in una linea di prodotti, in modo da accrescere le competenze specifiche del personale e ottimizzare i processi.

Indipendentemente dal tipo di prodotto, possiamo così rispondere all'evoluzione del mercato in termini di quantità, precisione e applicazione odontoiatrica.

Con centinaia di migliaia di prodotti spediti ogni anno, garantiamo un rigido controllo qualitativo e un sistema di tracciabilità scrupoloso per offrire il livello di efficacia, sicurezza e comfort che i pazienti si aspettano.



INTEGRAZIONE DIGITALE AVANZATA

Abbiamo rivoluzionato l'integrazione digitale dei nostri servizi. Tutti gli articoli del catalogo sono disponibili sia sul sito web che sull'app mobile, dove è possibile consultare modelli 3D e schede tecniche dettagliate. Grazie a un sistema avanzato di gestione, l'ordine e la preparazione sono ancora più efficaci,

integrandosi perfettamente con il magazzino verticale. Questo consente una spedizione che non è mai stata così veloce e precisa, garantendo ai nostri clienti un'esperienza di acquisto ottimale, riducendo i tempi di attesa e migliorando la soddisfazione generale.



IL NOSTRO IMPEGNO

Presso Asa Dental, la sostenibilità costituisce il fulcro delle nostre attività. Ci impegniamo attivamente per produrre un impatto positivo sull'ambiente e sulle comunità che serviamo. Attraverso pratiche innovative e scelte responsabili, cerchiamo di minimizzare il nostro impatto ecologico, preservare le risorse naturali e promuovere il benessere sociale. La nostra

dedizione inarrestabile alla sostenibilità ci spinge a migliorare costantemente i nostri processi, prodotti e servizi, garantendo così un futuro più luminoso e sostenibile per le generazioni a venire. Insieme, stiamo plasmando un mondo in cui la sostenibilità non è solo un obiettivo, ma un elemento intrinseco della nostra identità e delle nostre operazioni.



**2023
2024**

Nuovo impianto fotovoltaico al Centro Logistico

Introduzione packaging ZeroWaste con Smart Label



**2025
2026**

Riduzione al minimo l'utilizzo della colla e i fissaggi a caldo

Riduzione al minimo del packaging multimateriale



**2027
2028**

Carbon free

Applicazione di nuove strategie di riuso del packaging



**2029
2030**

Eliminazione del packaging multimateriale

Introduzione del packaging biodegradabile

INDICE DEI NOMI SCIENTIFICI

NOME SCIENTIFICO	CATEGORIA DI STRUMENTO	PAGINA
Adson	Pinzette chirurgiche	C38, E36
Adson	Porta aghi	C10
Adson-Brown	Pinzette chirurgiche	C41
Ainsworth	Strumenti per diga	F11
Allen	Scollaperiostio ed Elevatori	E23, H16
Apexo	Leve per radici con manico in acciaio inox	D56
Apexo	Leve per radici con manico in acciaio inox anatomico	D62
Arruga	Porta aghi	C15
Asa	Strumenti per modellare	L14
Backhaus	Pinze per pannolino	C31
Ball	Otturatori	F34
Barnhart	Curette e Scaler	H5
Baumgartner	Porta aghi	C11
Beale	Scollaperiostio ed Elevatori	E22, H16
Beale	Strumenti per modellare	L16
Bein	Leve per radici con manico in acciaio inox	D49, D50
Bein	Leve per radici con manico in acciaio inox anatomico	D61
Beyer	Pinze ossivore alveolotome	D44
Black/26	Strumenti per preparazione cavità	F21
Black/27	Strumenti per preparazione cavità	F21
Black/28	Strumenti per preparazione cavità	F21
Black/29	Strumenti per preparazione cavità	F21
Black/51-52	Strumenti per preparazione cavità	F22
Black/53-54	Strumenti per preparazione cavità	F22
Black/77-78	Strumenti per preparazione cavità	F21
Black/79-80	Strumenti per preparazione cavità	F21
Blumenthal	Pinze ossivore alveolotome	D43, E30
Boehm	Strumenti per corone	F45, L29
Boley	Strumenti per corone	F44, L30
Bowman	Sonde seno mascellare	C37
Brewer	Strumenti per diga	F12
Bruenings	Divaricatori	C34
Buchwald	Divaricatori	C34
Buck	Bisturi per gengivectomia	H24, H25
Buckley	Scalpellini e sgorbie per parodontologia	H27
Buser	Posizionatori di membrane	E31
Buser	Scollaperiostio ed Elevatori	E22, H16
Castroviejo	Porta aghi	C18, E6
Cattoni	Sonde doppie	B8
Chompret	Sindesmotomi con manico in acciaio inox	D67
Cleveland	Pinze ossivore alveolotome	D42
Cleveland-Gardner	Pinze ossivore alveolotome	D42
Cogswell	Leve per radici con manico in acciaio inox	D56
Coleman	Leve per radici con manico in acciaio inox	D48
Collin	Pinze tiralingua	C33

NOME SCIENTIFICO	CATEGORIA DI STRUMENTO	PAGINA
Columbia	Curette e Scaler	H4
Columbia	Divaricatori	C34
Cooley	Pinzette chirurgiche	C38
Coupland	Leve per radici con manico in acciaio inox	D58
Coupland	Leve per radici con manico in acciaio inox	D60
Crane-Kaplan	Bisturi per gengivectomia	H25
Crane-Kaplan (Goldman-Fox)	Curette e Scaler	H8
Crane-Kaplan (Goldman-Fox)	Pinzette per marcare le tasche	B3, E35, H31
Crite	Pinze emostatiche	C20
Crite-Wood	Porta aghi	C10, C11
Cryer	Leve per radici con manico in acciaio inox	D57
Cryer	Leve per radici con manico in acciaio inox anatomico	D62
Cryer	Pinze per estrazione - forma americana	D28
Cryer	Pinze per estrazione - forma americana - AsaLady	D32
Curtis	Leve per radici con manico in acciaio inox	D55
Darby-Perry	Escavatori	F20
De Marco	Curette e Scaler	H5
Dean	Forbicine per gengive	C7
Derf	Porta aghi	C13
Didner	Porta matrici	F48
Eiselberg-Mathieu	Porta aghi	C15
Fahnenstock	Coltelli per cera	L22
Farabeuf	Divaricatori	C35
Flagg	Pinzette per medicazioni	B4, B5
Flohr	Leve per radici con manico in acciaio inox	D51, D60
Flohr	Leve per radici con manico in acciaio inox anatomico	D61
Foc	Otturatori per amalgama, Strumenti per composito	F33, F51
Frahm	Strumenti per modellare, Strumenti per composito	F39, L13
Frazier	Cannule chirurgiche in acciaio inox	C44
Freer	Scalpellini Freer taglio singolo	E16
Freer	Scollaperiostio ed Elevatori	E24, H17
Friedman	Leve per radici con manico in acciaio inox	D59
Friedman	Pinze ossivore alveolotome	D42
Furrer	Strumenti per corone	F45
Gardner	Scalpellini e sgorbie per parodontologia	H27
Gillies	Porta aghi	C14
Goldman-Fox	Bisturi per gengivectomia	H25
Goldman-Fox	Combinazioni sonde - Sonde millimetriche	B10
Goldman-Fox	Curette e Scaler	H6
Goldman-Fox	Forbicine per gengive	C3, C4, E4
Goldman-Fox	Pinza per tessuti, Strumenti per Parodontologia	D44, E29, H30
Goldman-Fox	Scollaperiostio ed Elevatori	E22, H16
Goldman-Fox	Sonde millimetriche parodontali	H3
Goldman-Fox	Sonde per canali	B10
Goldman-Fox-Williams	Combinazioni sonde - Sonde millimetriche	B11
Gracey	Curette Gracey	G17, H11
Gracey	Curette Gracey - AF	H12
Gracey	Curette Gracey - MF	H13
Greenstein	Strumenti per ceramica e resine di rivestimento	L21
Gritman	Coltelli per gessi	L23
Gritman	Strumenti per modellare	L16
Gross-Maier	Pinze porta tamponi	C32

NOME SCIENTIFICO	CATEGORIA DI STRUMENTO	PAGINA
Halsey	Porta aghi	C13
Halsey-Smooth	Porta aghi	C13
Halstead-Mosquito	Pinze emostatiche	C21, F46, G19
Halstead-Mosquito	Strumenti per ortodonzia	I36
Harris	Pinze per estrazione - forma americana	D26
Harris	Pinze per estrazione - forma americana - AsaLady	D30
Hartmann	Pinze emostatiche	C23
Hegar-Baumgartner	Porta aghi	C11
Heidbrink	Leve per radici con manico in acciaio inox	D56
Heidbrink	Leve per radici con manico in acciaio inox anatomico	D62
Heidbrink	Mini-leve per frammenti di radici con manico in acciaio inox	D65, D66
Hemingway	Cucchiai alveolari	C45, E21, H20
Herbert	Martelli chirurgici	H29
Hirschfeld	Lime	H22
Hollenback	Otturatori per amalgama	F31
Hollenback	Strumenti per composito	F51
Hollenback	Strumenti per modellare	F38, L13
Hopkins	Scollaperiostio ed Elevatori	E24, H17
Hourigan	Scollaperiostio ed Elevatori	E23, H16
Howard	Lime per alveolotomia	H23
Hull	Pinze per estrazione - forma americana	D27
Hull	Pinze per estrazione - forma americana - AsaLady	D31
Hygienist	Scaler	H15
Hyltin	Leve per radici con manico in acciaio inox	D45
Hyltin	Strumenti per modellare	L14
Hyltin-Le Cron	Strumenti per modellare	L14
Indiana University	Curette e Scaler	H5
Iris	Forbicine per gengive	C4, C5
Ivory	Porta matrici	F48
Ivory	Strumenti per diga	F11, F12
Ivory	Vision® Shade	F4
Iwanson	Strumenti per corone	F44, L30
Jacquette	Curette e Scaler	H9
Jacquette	Scaler	H15
Jameson	Strumenti per corone	L30
Jones	Pinze per pannolino	C31
Kelly	Forbicine per gengive	C5, E4
Kelly	Pinze emostatiche	C23, F46
Kilner	Divaricatori	C35
Kirkland	Bisturi per gengivectomia	H24
Kocher	Divaricatori	C36
Kocher	Pinze emostatiche	C20
Konig	Scollaperiostio ed Elevatori	E25, H18
Kopp	Leve per radici con manico in acciaio inox	D52
Ladmore	Otturatori	F34
LaGrange	Forbicine per gengive	C7
Langenbeck	Divaricatori	C36
Langer	Curette e Scaler	H5
Le Cron	Strumenti per modellare	L15
Lecluse	Leve per radici con manico in acciaio inox anatomico	D65
Lessman	Coltelli per cera	L22
Lichtenberg	Porta aghi	C15, E5

NOME SCIENTIFICO	CATEGORIA DI STRUMENTO	PAGINA
Locklin	Forbicine per gengive	C6
London College	Pinzette per medicazioni	B4, B5
London Hospital	Leve per radici con manico in acciaio inox	D48
Lucas	Cucchiai alveolari	H20
Luer	Pinze ossivore alveolotome	D42, E30
Luks	Otturatori per canali	B13, G5
Luniatschek	Strumenti operativi, Strumenti per ortodonzia	F41, I36
Machtou	Otturatori per canali	B13, G5
MacMillan	Leve per radici con manico in acciaio inox	D58
Markley	Otturatori per amalgama	F32
Marquette	Otturatori per amalgama	F31
Mathieu	Porta aghi	C16, C17, E5
Mayo	Forbicine per gengive	C8
Mayo-Hegar	Porta aghi	C12
McCall	Curette e Scaler	H7
Mead	Martelli chirurgici	E16, H29
Mead	Pinze ossivore alveolotome	D43
Mead	Scollaperiostio ed Elevatori	E24, H17
Meriam	Pinzette per laboratorio	L19
Meriam	Pinzette per medicazioni	B4, B5
Merrit	Sonde millimetriche parodontali	H3
Mershon	Strumenti per ortodonzia	I34
Metzenbaum	Forbicine per gengive	C8
Metzenbaum-Delikat	Forbicine per gengive	C8, E4
Micro-Adson	Pinzette chirurgiche	C38, C39, G18
Micro-Mosquito	Pinze emostatiche	C22, F46
Middeldorp	Divaricatori	C37, E12
Miller	Lime per alveolotomia	E21, H23
Miller	Strumenti per corone	F44
Miller-Apexo	Leve per radici con manico in acciaio inox	D54
Miller-Apexo	Leve per radici con manico in acciaio inox anatomico	D62
Mini Crane-Kaplan	Curette e Scaler	H8
Mini Friedman	Leve per radici con manico in acciaio inox	D59
Mini Friedman	Pinze ossivore alveolotome, Strumenti per Parodontologia	D42, E30, H30
Mini-Ruskin	Pinze ossivore alveolotome	D44
Mini-Ryder	Porta aghi	C13
Minnesota University	Divaricatori	C34, E12
Molt	Apribocca	C33
Molt	Scollaperiostio ed Elevatori	E23, H16
Nabers	Sonde doppie	B11
Neumann	Forbicine per gengive	C7
Nevius	Pinze per estrazione - forma americana	D27
Nevius	Pinze per estrazione - forma americana - AsaLady	D31
Novatech	Sonde millimetriche parodontali	H3
Noyes	Forbicine per gengive	C7
Ochsenbein	Scalpellini chirurgici	H26
Ochsenbein	Scalpellini e sgorbie per parodontologia	H27
Ogden-Felsch	Pinze per estrazione	D19
Olsen-Hegar	Porta aghi	C10
Orban	Bisturi per gengivectomia	H24
Orban	Strumenti operativi	F41
Orringer	Divaricatori	C34, E11

NOME SCIENTIFICO	CATEGORIA DI STRUMENTO	PAGINA
P. K. Thomas	Strumenti per composito	F50, F52
P. K. Thomas	Strumenti per modellare	L17
Partsch	Martelli chirurgici	E16, H29
Partsch	Scalpellini e sgorbie per parodontologia	H28
Partsch	Scollaperiostio ed Elevatori	E24, H17
Pean	Pinze emostatiche	C20
Perry	Pinzette per medicazioni	B4
Physick	Pinze per estrazione - forma americana	D25
Physick	Pinze per estrazione - forma americana - AsaLady	D29
Polokoff	Lime per alveolotomia	H23
Pott	Leve per radici con manico in acciaio inox anatomico	D65
Prichard	Scollaperiostio ed Elevatori	E23, H16
Quinby	Forbicine per gengive	C5
Rhodes	Scalpellini chirurgici	H26
Roach	Strumenti per modellare	L16
Roser-Koenig	Apribocca	C33
Roturier	Pinze per estrazione	D6, D7, D16
Rule	Curette e Scaler	H5
Sanders	Bisturi per gengivectomia	H25
Schaedle	Pinze per pannolino	C31
Schilder	Otturatori per canali	B14, G6
Schluger	Lime	H22
Schmeckebier-Apexo	Leve per radici con manico in acciaio inox	D51
Schmeckebier-Apexo	Leve per radici con manico in acciaio inox anatomico	D61
Seldin	Leve per radici con manico in acciaio inox	D54, D55, D56
Seldin	Leve per radici con manico in acciaio inox anatomico	D62
Seldin	Scollaperiostio ed Elevatori	E25, G16, H18
Semken-Taylor	Pinzette chirurgiche	C41, E36
Senn-Miller	Divaricatori	C35
Spencer	Forbicine per gengive	C8
SS. White	Escavatori	F19
Sternberg	Divaricatori	C34, E11
Stevens	Forbicine per gengive	C9
Stieglitz	Pinze per radici e frammenti, Strumenti endodontici	
Stoke	Strumenti per diga	F12
Stout	Leve per radici con manico in acciaio inox	D55
Sugarman	Lime	H22
Sullivan	Forbicine per gengive	C6
Tanner	Otturatori per amalgama	F31
Taylor	Curette e Scaler	H8
TG Chisel	Scalpellini chirurgici	H26
Toennis	Porta aghi	C14
Tofflemire	Matrici	F49
Tofflemire	Porta matrici	F48
Tomati	Strumenti per Parodontologia	H30
Tomes	Pinze per estrazione - forma americana	D27
Tomes	Pinze per estrazione - forma americana - AsaLady	D31
Towner	Scaler	H14
Towner-Jacquette	Scaler	H14
Townley	Strumenti per corone	L30
Trotter	Pinze per estrazione	D17, D19, D20
U.S.A. model	Cucchiari alveolari	H21

NOME SCIENTIFICO	CATEGORIA DI STRUMENTO	PAGINA
Universal Scaler	Scaler	H14
University of Michigan	Combinazioni Sonde - Sonde millimetriche	B10
University of Michigan	Sonde millimetriche parodontali	H3
USC Towner	Bisturi per gengivectomia	H25
Vehe	Strumenti per modellare	L16
Vickers	Martelli chirurgici	H29
W.F. Barry	Leve per radici con manico in acciaio inox anatomico	D63
Wahl	Lime per alveolotomia	H23
Wakefield	Scalpellini e sgorbie per parodontologia	H27
Ward	Otturatori per amalgama	F31
Ward	Strumenti per modellare	F38, L13
Warwick-James	Mini-leve per frammenti di radici con manico in acciaio inox	D66
Wedelstaet	Strumenti per preparazione cavità	F22
Westcott	Forbicine per gengive	C7, G19
Westcott	Otturatori	F34
Westcott	Otturatori per amalgama	F28
White	Pinze per estrazione	D17
Wiland	Strumenti per modellare	F39
Williams	Combinazioni Sonde - Sonde millimetriche	B10
Williams	Sonde millimetriche parodontali	H3
Williger	Cucchiari alveolari	H21
Williger	Divaricatori	C35
Williger	Scollaperiostio ed Elevatori	E25, H19
Winter	Leve per radici con manico in acciaio inox anatomico	D64
Witzel	Pinze per radici	D40
Woodson	Strumenti per otturazioni plastiche	F37
Woodward	Leve per radici con manico in acciaio inox	D58
Younger-Good	Curette e Scaler	H8
Zahle	Strumenti per modellare	L15, L16
Zerfing-Chisel	Curette e Scaler	H4

ASAONE

MADE IN ITALY



NUMERI UNO NEL MONOUSO DI QUALITÀ

Asa Dental ha sfruttato la propria esperienza progettuale e produttiva, che ha reso le proprie cannule aspirasaliva le più vendute al mondo, estendendola a un'intera famiglia di prodotti. Il risultato è AsaOne, la linea monouso pensata per la sicurezza e il comfort dei professionisti del settore dentale e dei loro pazienti.

Materiali sicuri, uniti ad un design innovativo, sposano forma e colore per rendere qualsiasi studio dentale uno spazio accogliente dove ottenere i risultati migliori.

A2 Cannule aspirasaliva

A6 Salviette

A8 Dappen dishes

A10 Vassoi in plastica

A11 Rulli di cotone

A12 Rotoli per sterilizzare

A13 Mascherine chirurgiche

A14 Buste per sterilizzare

A15 Mantelline

A16 Accessori

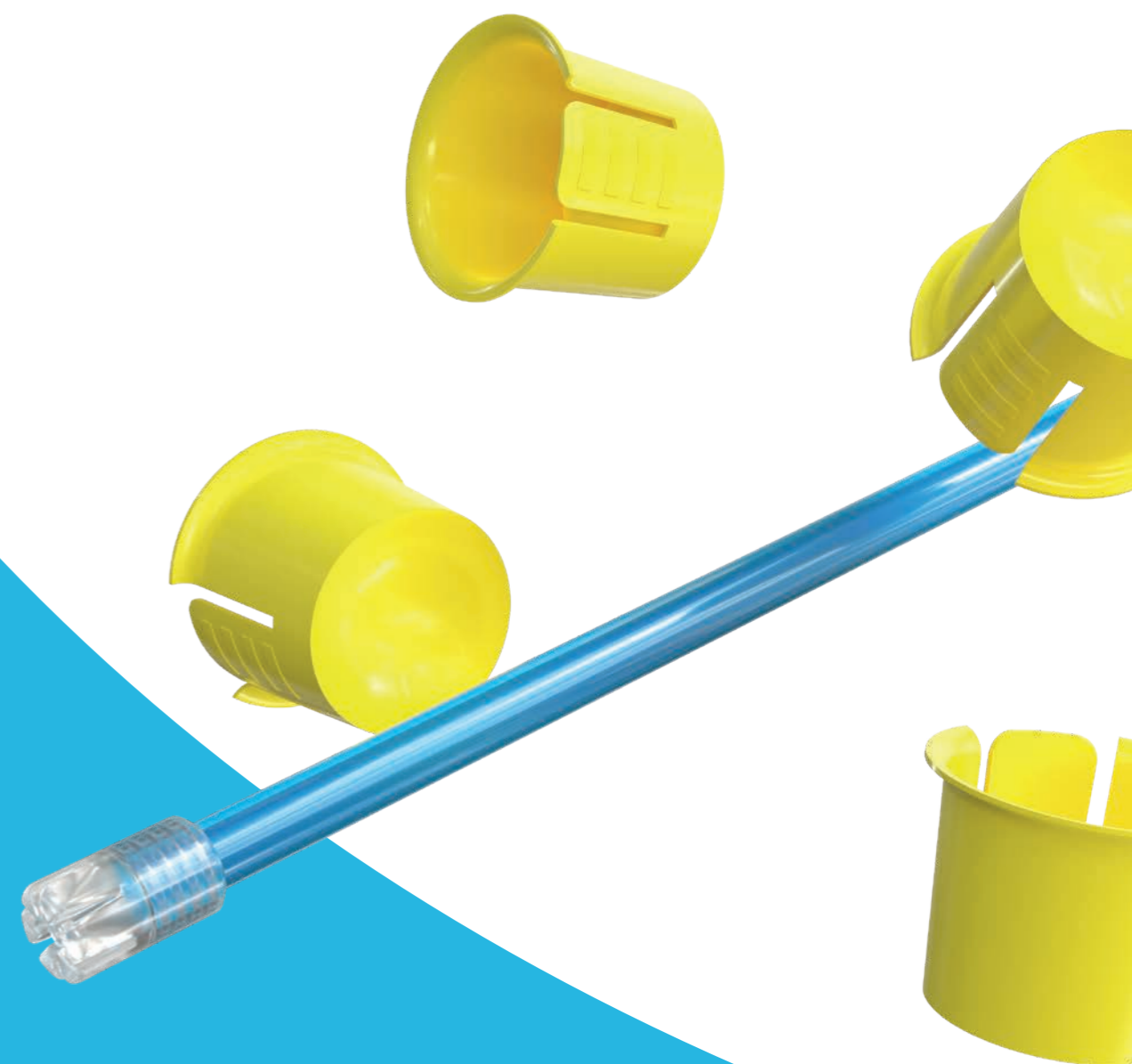

CANNULE AL PROFUMO DI MENTA - ASAFRESH



Punta rimovibile
100 pz / sacchetto
10 sacchetti / cartone
1000 pz

2908E-AT13/15
tubo blu
punta trasparente

2908E-TT13/T15
tubo trasparente
punta trasparente

2908E-VT13/15
tubo verde
punta trasparente



150 mm
2908E-AT15
130 mm
2908E-AT13



150 mm
2908E-TT15
130 mm
2908E-TT13



150 mm
2908E-VT15
130 mm
2908E-VT13

Punta saldata
100 pz / sacchetto
10 sacchetti / cartone
1000 pz

2908E-BBS15
tubo bianco
punta bianca

2908E-TCS15
tubo trasparente
punta azzurra

2908E-TTS15
tubo trasparente
punta trasparente

2908E-VTS15
tubo verde
punta trasparente



150 mm
2908E-BBS15



150 mm
2908E-TCS15



150 mm
2908E-TTS15

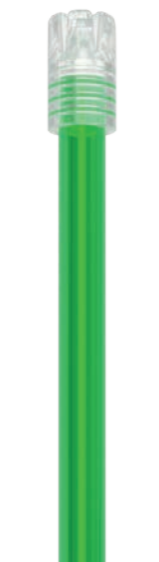

150 mm
2908E-VTS15

CANNULE CON CAPPuccio MORBIDO - TOTAL-COMFORT



Punta rimovibile
100 pz / sacchetto
10 sacchetti / cartone
1000 pz

2903E-BA155
tubo bianco
punta blu

2903E-BT155
tubo bianco
punta trasparente

2903E-TA155
tubo trasparente
punta blu

2903E-TT155
tubo trasparente
punta trasparente



155 mm
2903E-BA155



155 mm
2903E-BT155



155 mm
2903E-TA155



155 mm
2903E-TT155

Punta saldata
100 pz / sacchetto
10 sacchetti / cartone
1000 pz

2903E-BAS155
tubo bianco
punta blu

2903E-BTS155
tubo bianco
punta trasparente

2903E-TAS155
tubo trasparente
punta blu

2903E-TTS155
tubo trasparente
punta trasparente



155 mm
2903E-BAS155



155 mm
2903E-BTS155



155 mm
2903E-TAS155



155 mm
2903E-TTS155

CANNULE MULTI-COLOR



2900E

Punta rimovibile
100 pz / sacchetto
10 sacchetti / cartone
1000 pz

2900E-AT13/15
tubo blu
punta trasparente

2900E-TT13/15
tubo trasparente
punta trasparente

2900E-VT13/15
tubo verde
punta trasparente

2900E-BT13/15
tubo bianco
punta trasparente

2900E-GT13/15
tubo giallo
punta trasparente

2900E-LT13/15
tubo lilla
punta trasparente



150 mm
2900E-AT15
2901E-AT15
130 mm
2900E-AT13
2901E-AT13



150 mm
2900E-TT15
2901E-TT15
130 mm
2900E-TT13
2901E-TT13



150 mm
2900E-VT15
2901E-VT15
130 mm
2900E-VT13
2901E-VT13

2901E

Punta rimovibile
250 pz / sacchetto
20 sacchetti / cartone
5000 pz

2901E-AT13/15
tubo blu
punta trasparente

2901E-TT13/T15
tubo trasparente
punta trasparente

2901E-VT13/15
tubo verde
punta trasparente



150 mm
2900E-BT15
130 mm
2900E-BT13



150 mm
2900E-GT15
130 mm
2900E-GT13



150 mm
2900E-LT15
130 mm
2900E-LT13

CANNULE MULTI-COLOR



Punta rimovibile
100 pz / sacchetto
10 sacchetti / cartone
1000 pz

2900E-OT13/15
tubo arancio
punta trasparente

2900E-RT13/15
tubo rosso
punta trasparente

2900E-ZT13/15
tubo ciano
punta trasparente



150 mm
2900E-OT15
130 mm
2900E-OT13



150 mm
2900E-RT15
130 mm
2900E-RT13



150 mm
2900E-ZT15
130 mm
2900E-ZT13

Punta saldata
100 pz / sacchetto
10 sacchetti / cartone
1000 pz

2900E-ATS15
tubo blu
punta trasparente

2900E-BBS15
tubo bianco
punta bianca

2900E-TCS15
tubo trasparente
punta azzurra

2900E-TTS15
tubo trasparente
punta trasparente

2900E-VTS15
tubo verde
punta trasparente



150 mm
2900E-ATS15



150 mm
2900E-BBS15



150 mm
2900E-TCS15



150 mm
2900E-TTS15

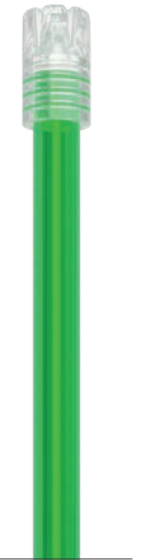

150 mm
2900E-VTS15

SALVIETTE - ASARAINBOW

33x45 cm a due veli

3509
cartone da 500 pz

33x45 cm a tre veli

3510
cartone da 500 pz

3511
disponibile su richiesta
50 pz / busta
10 buste / cartone
500 pz
Minimo 80 cartoni per colore (1 Pallet)

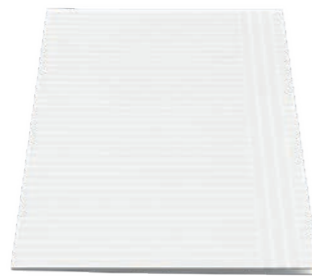

Bianco

3509-B	normale
3510-B	normale
3510.B	Medical Device
3511-B	normale
3511.B	Medical Device

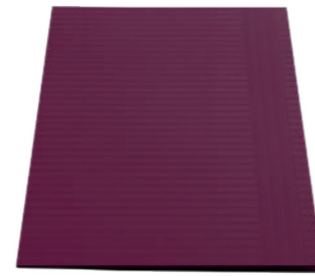

Bordeaux

3510-BX	normale
3510.BX	Medical Device
3511-BX	normale
3511.BX	Medical Device



Celeste

3509-C	normale
3510-C	normale
3510.C	Medical Device
3511-C	normale
3511.C	Medical Device

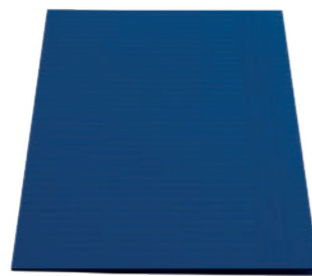

Blu scuro

3509-D	normale
3510-D	normale
3510.D	Medical Device
3511-D	normale
3511.D	Medical Device



Fucsia

3510-F	normale
3510.F	Medical Device
3511-F	normale
3511.F	Medical Device



Giallo

3510-G	normale
3510.G	Medical Device
3511-G	normale
3511.G	Medical Device

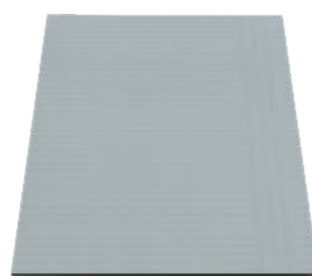

Grigio

3510-GR	normale
3510.GR	Medical Device
3511-GR	normale
3511.GR	Medical Device

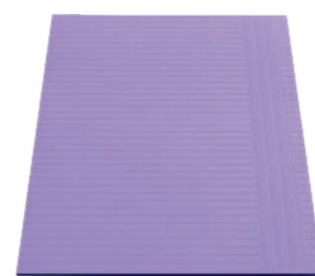

Lilla

3509-L	normale
3510-L	normale
3510.L	Medical Device
3511-L	normale
3511.L	Medical Device

SALVIETTE - ASARAINBOW



Lime

3510-LI	normale
3510.LI	Medical Device
3511-LI	normale
3511.LI	Medical Device

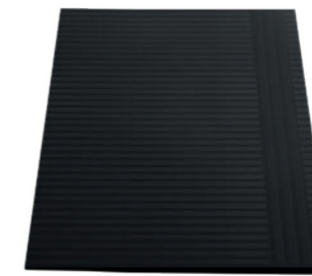

Nero

3509-N	normale
3510-N	normale
3510.N	Medical Device
3511-N	normale
3511.N	Medical Device



Arancio

3510-O	normale
3510.O	Medical Device
3511-O	normale
3511.O	Medical Device

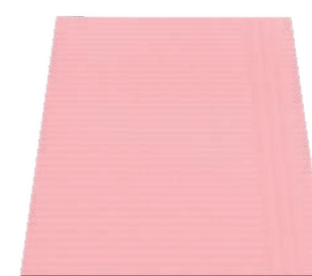

Rosa

3509-P	normale
3510-P	normale
3510.P	Medical Device
3511-P	normale
3511.P	Medical Device



Pesca

3510-PE	normale
3510.PE	Medical Device
3511-PE	normale
3511.PE	Medical Device



Verde

3509-V	normale
3510-V	normale
3510.V	Medical Device
3511-V	normale
3511.V	Medical Device

Catenella reggi salviette



3201



DAPPEN DISHES

50 pz / sacchetto
 5 sacchetti per colore / cartone
 1000 pz



Giallo + Rosso + Bianco + Blu
 3700-MX



DAPPEN DISHES

50 pz / sacchetto
 20 sacchetti per colore / cartone
 1000 pz



Nero
 3700-N



Giallo
 3700-G



Blu
 3700-C



Bianco
 3700-B



Rosso
 3700-R

VASSOI IN PLASTICA

281x183x17 mm

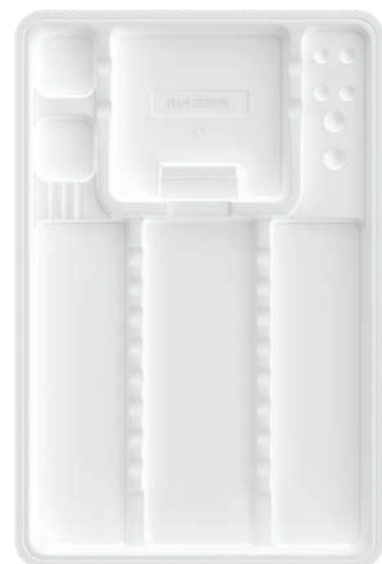

Bianco liscio
AL2727-1

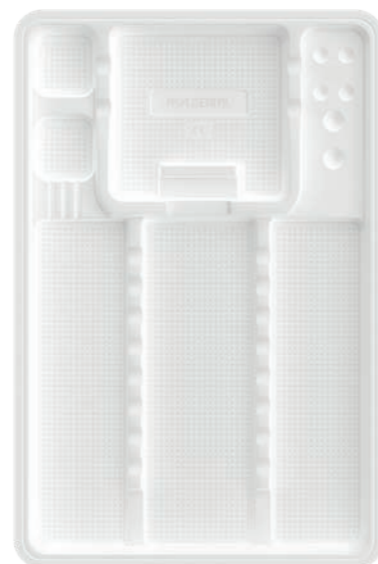

Bianco zigrinato
AL2727-1Z

183x140x17 mm



Bianco liscio
AL2727-2



Bianco zigrinato
AL2727-2Z

200x150 mm
400 pz / confezione



Bianco liscio
AL2738-1

200x100 mm
400 pz / confezione



Bianco liscio
AL2738-2

RULLI DI COTONE

In sacchetto
100% cotone
300 gr. / sacchetto
20 sacchetti / cartone

Ø 8 mm | 840 pz
3520-1



In sacchetto
100% cotone
300 gr. / sacchetto
20 sacchetti / cartone

Ø 10 mm | 600 pz
3520-2



In sacchetto
100% cotone
300 gr. / sacchetto
20 sacchetti / cartone

Ø 12 mm | 450 pz
3520-3



ROTOLE PER STERILIZZARE

Carta a elevata grammatura e film di polipropilene con indicatore di avvenuto processo di sterilizzazione.

8 pz / cartone

50 mm x 200 m
3400E-55

75 mm x 200 m
3400E-75

4 pz / cartone

100 mm x 200 m
3400E-100

150 mm x 200 m
3400E-150

2 pz / cartone

200 mm x 200 m
3400E-200

250 mm x 200 m
3400E-250

1 pz / cartone

300 mm x 200 m
3400-300



MASCHERINE CHIRURGICHE

Mascherine con elastici

Materiali di alta qualità in TNT ipoallergeniche prive di fibre di vetro livello di B.F.E. 99,7%

50 pz / scatola
6 scatole / cartone
300 pz

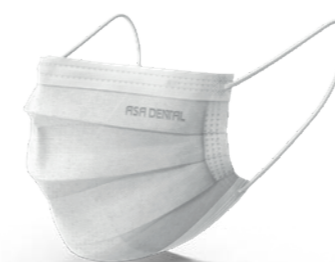

Bianco
3450E-B



Celeste
3450E-C



Nera
3450E-N



Rosa
3450E-R



Verde
3450E-V

BUSTE PER STERILIZZARE

Buste autosigillanti

200 pz / scatola
12 scatole / cartone
2400 pz



75x250 mm
3403-75



90x230 mm
3403-90

200 pz / scatola
8 scatole / cartone
1600 pz



140x250 mm
3403-140

MANTELLINE

Rotoli a strappo

impermeabili
due strati di polietilene e carta

3251E
50x60 cm
80 strappi
6 rotoli / cartone

3252E
50x80 cm
60 strappi
6 rotoli / cartone



Celeste
3251E-C/6
3252E-C/6



Blu scuro
3251E-D/6
3252E-D/6



Arancio
3251E-O/6
3252E-O/6



Verde
3251E-V/6
3252E-V/6

BICCHIERI

200 cc
100 pz / confezione
30 confezioni / cartone
3000 pz



Bianco
3818-B

DISTRIBUTORI PER BICCHIERI

85 x 85 x 360 mm
per max 70 bicchieri



Argento
2750-1



Bianco
2750-2

SPATOLE PER MISCELAZIONE IN PLASTICA

100 pz / confezione



AL2736

PORTA AGHI USATI

contenitore in plastica



AL2766

VASSOI PER MISCELAZIONE

70x54x6 mm
12 cavità
1000 pz / confezione



AL2735

SIRINGHE IN PLASTICA

per elastomeri
50 pz / scatola
10 scatole / cartone
500 pz



3710

PORTARIFIUTI

1000 pz / confezione

Supporto in alluminio per portarifiuti



AL2767-1



AL2767-2

GHIACCIO ISTANTANEO SINTETICO

14x18 cm
 sacchetto in TNT
 temperatura -4°C
 25 sacchetti / cartone



3600E

PORTAIMPRONTE IN PLASTICA MONOUSO

24 pz / confezione



12 inferiori + 12 superiori (per misura)



1
2853E-1

2
2853E-2



3
2853E-3

4
2853E-4

12 parziali destri + 12 parziali sinistri (per misura)



1
2853E-1DS

2
2853E-2DS

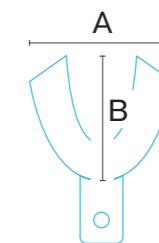

Inferiori	A (mm)	B (mm)
1	61	50
2	67	52
3	72	56
4	74	58

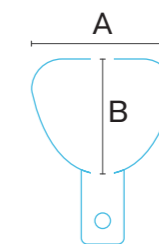

Superiori	A (mm)	B (mm)
1	61	49
2	65	53
3	70	59
4	73	63

DIAGNOSTICA

MADE IN ITALY



LA NOSTRA GAMMA DI STRUMENTI PER UNA DIAGNOSI COMPLETA ED EFFICIENTE

Uno degli obiettivi principali nella cura dentale è quello di favorire nel tempo la salute orale del paziente. Tutto ciò è possibile grazie ad una diagnosi affidabile, che permetta di comunicare in modo chiaro ed efficace con il paziente.

Per questa ragione abbiamo progettato strumenti diagnostici utilizzando materiali e forme che offrono il compromesso ideale tra precisione, elasticità, resistenza ed ergonomia, enfatizzando ciascuna caratteristica in base allo scopo dello strumento.

B3 Pinzette per marcare le tasche

B3 Pinzette per medicazioni

B6 Sonde

B10 Combinazioni sonde - sonde millimetriche

B12 Condensatori per trattamenti canalari

B13 Pluggers

B15 Condensatori

B15 Escavatori

B17 Specchietti

B21 Divaricatori ultralight

B22 Kit



MANICI

PUNTA SINGOLA

- Asa60**
(acciaio inox)
ø 6,0 mm
- Asa60M**
(acciaio inox, monoblocco)
ø 6,0 mm
- Leonardo ML**
(acciaio inox)
ø 7,0 mm
- **Alu80**
(alluminio, vuoto)
ø 8,0 mm
- **AsaWave RC**
(resina plastica in PPSU
e anima in acciaio)
ø 7,5 / 14,5 mm



PUNTA DOPPIA

- Asa60**
(acciaio inox)
ø 6,0 mm
- Asa Light MV**
(acciaio inox, vuoto)
ø 8,0 mm
- Leonardo ML**
(acciaio inox)
ø 7,0 mm
- **AsaWave RC**
(resina plastica in PPSU
e anima in acciaio)
ø 7,5 / 14,5 mm

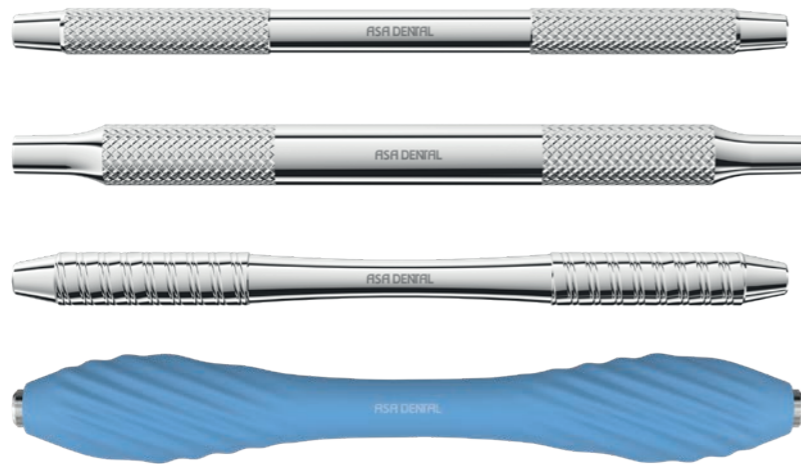

COME USARE LE INFORMAZIONI

- 3R Rhein** → modello + nome scientifico
- 0700-3R** → codice Asa Dental
- Asa60 → manico

AsaLady

prodotti ergonomici progettati su misura per le mani femminili:

- manici ridotti e più leggeri
- anelli delle dita più piccoli
- dimensioni ridotte

codici con prefissi "W" o "SW"

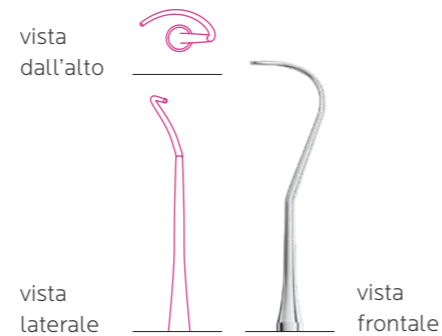
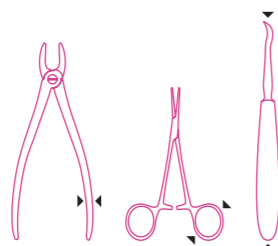

PINZETTE PER MARCARE LE TASCHE



1 (Crane-Kaplan)
Goldman-Fox
15 cm
0650-1

2 (Crane-Kaplan)
Goldman-Fox
15 cm
0650-2

PINZETTE PER MEDICAZIONI
con bloccaggio

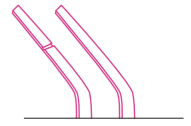

18L
16 cm
0600-18L

1
15 cm
0602-1

2
15 cm
0602-2

PINZETTE PER MEDICAZIONI

Set da 5



1 Flagg
S0601-1

2 London-College
S0601-2

3 Meriam
S0601-3



1
Flagg
16 cm
0601-1

2
London-College
15,5 cm
0601-2

3
Meriam
16 cm
0601-3

4
Perry
13 cm
0601-4

5
Perry
13 cm
0601-5

4
Perry
13 cm
0600-4

2
London-College
16 cm
0600-2

PINZETTE PER MEDICAZIONI



0600-2

Antimagnetiche e facili da pulire, le pinzette Asa Dental sono sufficientemente leggere da garantire il comfort operativo necessario e tuttavia resistenti per permetterne un uso efficace nel tempo.

Le diverse forme delle punte e le varie inclinazioni permettono l'utilizzo in qualsiasi situazione. La punta presenta un rivestimento antiaderente ai materiali da otturazione, rendendola un versatile strumento per il loro posizionamento all'interno della cavità.



3
16 cm
0600-3

17
16 cm
0600-17

18
16 cm
0600-18

19
16,5 cm
0600-19

1
Flagg
14 cm
W0610-1

2
London College
14 cm
W0610-2

3
Meriam
15 cm
W0610-3

AsaLady

AsaLady

AsaLady

SONDE SINGOLE



3
0700-3
Asa60
0701-3
Asa60M



3A
0700-3A
Asa60
0701-3A
Asa60M



3R Rhein
0700-3R
Asa60
ML0700-3R
Leonardo ML



5
0700-5
Asa60
0701-5
Asa60M



6
0700-6
Asa60
0701-6
Asa60M
ML0700-6
Leonardo ML
RC0700-6
● AsaWave RC



8
0700-8
Asa60
0701-8
Asa60M
ML0700-8
Leonardo ML



9
0700-9
Asa60
0701-9
Asa60M
ML0700-9
Leonardo ML
● AsaWave RC



10
0700-10
Asa60
0701-10
Asa60M



11
0700-11
Asa60
0701-11
Asa60M



12
0700-12
Asa60
0701-12
Asa60M



16
0700-16
Asa60
0701-16
Asa60M



17
0700-17
Asa60
0701-17
Asa60M
ML0700-17
Leonardo ML



17A
0700-17A
Asa60
0701-17A
Asa60M



23
0700-23
Asa60
0701-23
Asa60M
ML0700-23
Leonardo ML
RC0700-23
● AsaWave RC

SONDE SINGOLE

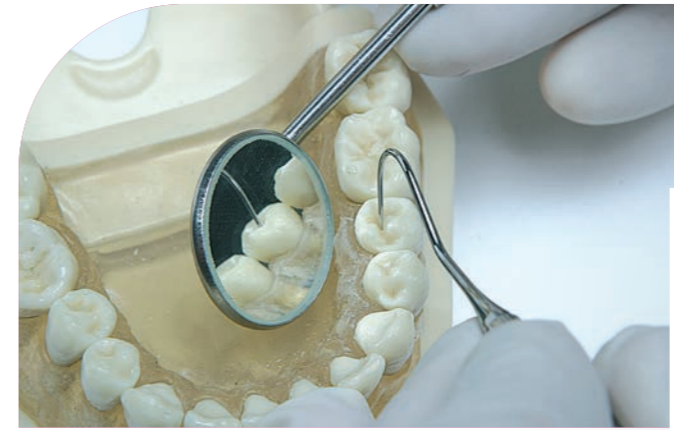

0700-23

Sonde ben affilate e acuminata, perfette per individuare anche le carie più piccole, offrono il bilanciamento ideale fra elasticità e rigidità.

Grazie alla punta sottile e alla flessibilità controllata, sono estremamente utili per la rilevazione di fessure, per il sovradimensionamento nelle otturazioni e per la verifica della corretta chiusura marginale nelle riabilitazioni protesiche fisse.

Set da 5
Asa60

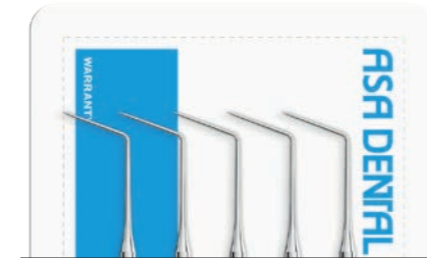

6
S0700-6

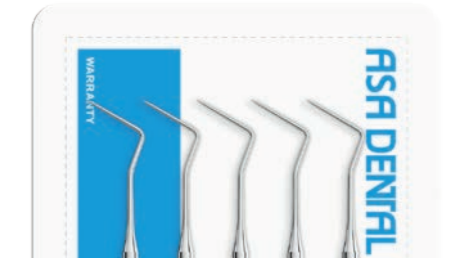

9
S0700-9



11
S0700-11

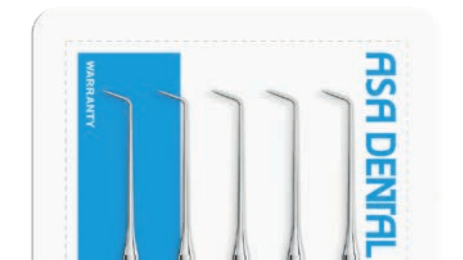

16
S0700-16



23
S0700-23

SONDE DOPPIE



6/9
ML0704-6D9
 Leonardo ML
0704-6D9
 Asa60

 11/12AF 0704-11/12AF Asa60 ML0704-11/12AF Leonardo ML	 16/23 0704-16D1 Asa60 MV0704-16D1 Asa Light MV	 16/3 0704-16D2 Asa60 MV0704-16D2 Asa Light MV	 23/17 0704-23D1 Asa60 MV0704-23D1 Asa Light MV ML0704-23D1 Leonardo ML RC0704-23D1 ● AsaWave RC
 23/17A 0704-23D2 Asa60 MV0704-23D2 Asa Light MV	 UT 1/2 Cattoni 0704-UT1 Asa60 MV0704-UT1 Asa Light MV	 2 0709-2 Asa60 MV0709-2 Asa Light MV	 2A 0709-2A Asa60 MV0709-2A Asa Light MV

SONDE DOPPIE

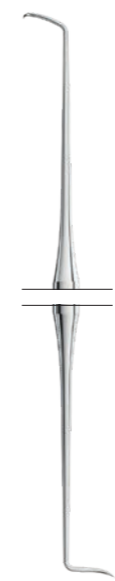

3
0709-3
 Asa60
MV0709-3
 Asa Light MV

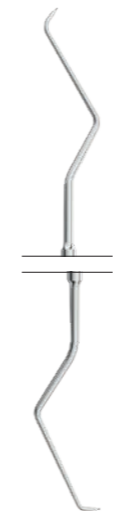

17/19
ML0704-6D2
 Leonardo ML

SONDE PER CANALI



6/1
MV0710-6D1
 Asa Light MV
0710-6D1
 Asa60

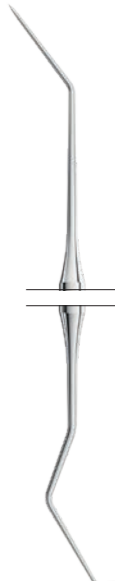

6/17
0710-6D2
 Asa60
MV0710-6D2
 Asa Light MV

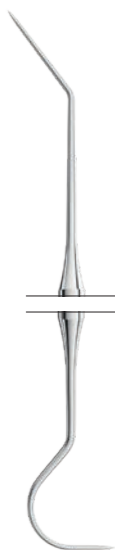



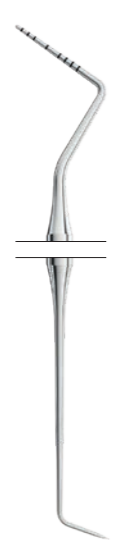
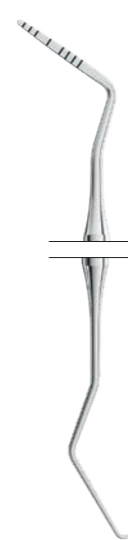
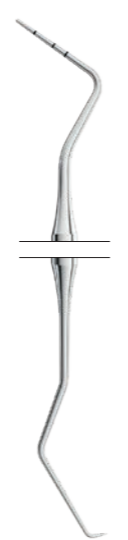
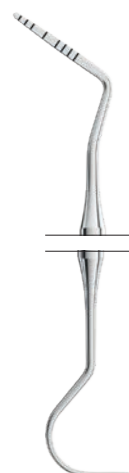
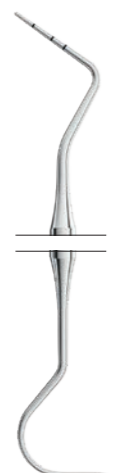
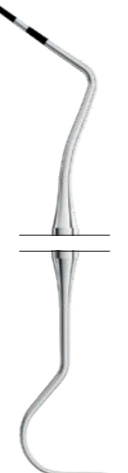
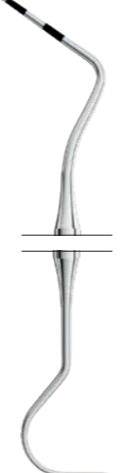

6/23
0710-6D3
 Asa60
MV0710-6D3
 Asa Light MV

COMBINAZIONI SONDE - SONDE MILLIMETRICHE

1 2 3 5 7 8 9 10 PUNTA PIATTA	1 2 3 5 7 8 9 10 PUNTA PIATTA	1 2 3 5 7 8 9 10	1 2 3 5 7 8 9 10 PUNTA PIATTA	3 6 8	1 2 3 5 7 8 9 10
					
3 Goldman-Fox 0705L-3GF Asa60 MV0705-3GF Asa Light MV	16 Goldman-Fox 0705L-16GF Asa60 MV0705-16GF Asa Light MV	16 Williams 0705L-16W Asa60 MV0705-16W Asa Light MV	17 Goldman-Fox 0705L-17GF Asa60 MV0705-17GF Asa Light MV	17 University of Michigan 0705L-17UM Asa60 MV0705-17UM Asa Light MV	17 Williams 0705L-17W Asa60 MV0705-17W Asa Light MV
	1 2 3 5 7 8 9 10 PUNTA PIATTA	3 6 8	1 2 3 5 7 8 9 10	3 6 8 11	3 6 9 12
					
	23 Goldman-Fox 0705L-23GF Asa60 MV0705-23GF Asa Light MV	23 University of Michigan 0705L-23UM Asa60 MV0705-23UM Asa Light MV	23 Williams 0705L-23W Asa60 MV0705-23W Asa Light MV ML0705-23W Leonardo ML	23/CP11 0706L-2311 Asa60 MV0706-2311 Asa Light MV	23/CP12 0706L-2312 Asa60 MV0706-2312 Asa Light MV

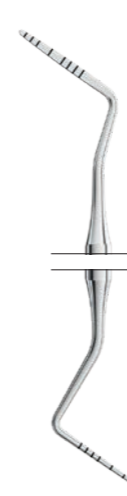
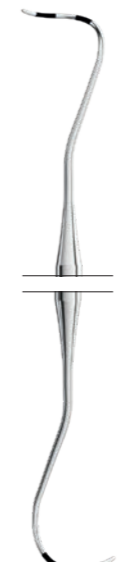
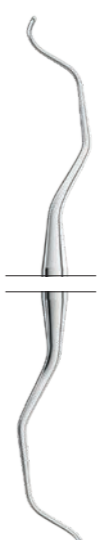
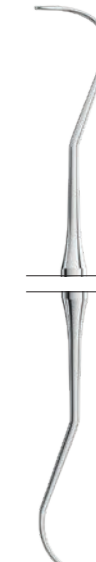
SONDE DOPPIE

1 2 3 5 7 8 9 10 12 14	1 2 3 5 7 8 9 10 PUNTA PIATTA	3 6 9 12		
				
Goldman-Fox Williams 0707L-GFW Asa60 MV0707-GFW Asa Light MV	12 3 5 7 8 9 10 Goldman-Fox Williams 0707L-GFW Asa60 MV0707-GFW Asa Light MV	12 9 6 3 2N Nabers 0708L-2N Asa60	1N Nabers 0708-1N Asa60 MV0708-1N Asa Light MV	2N Nabers 0708-2N Asa60 MV0708-2N Asa Light MV ML0708-2N Leonardo ML
1 2 3 5 7 8 9 10 12 14				
				
Goldman-Fox Williams RC0707-GFW ● AsaWave RC				



MV0707L-GFW

CONDENSATORI PER TRATTAMENTI CANALARI

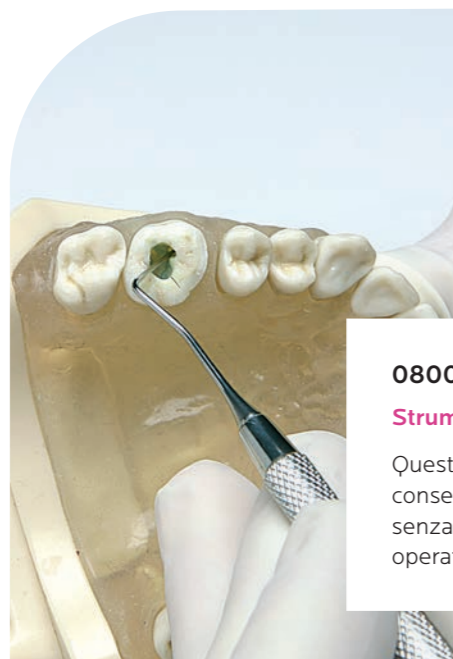
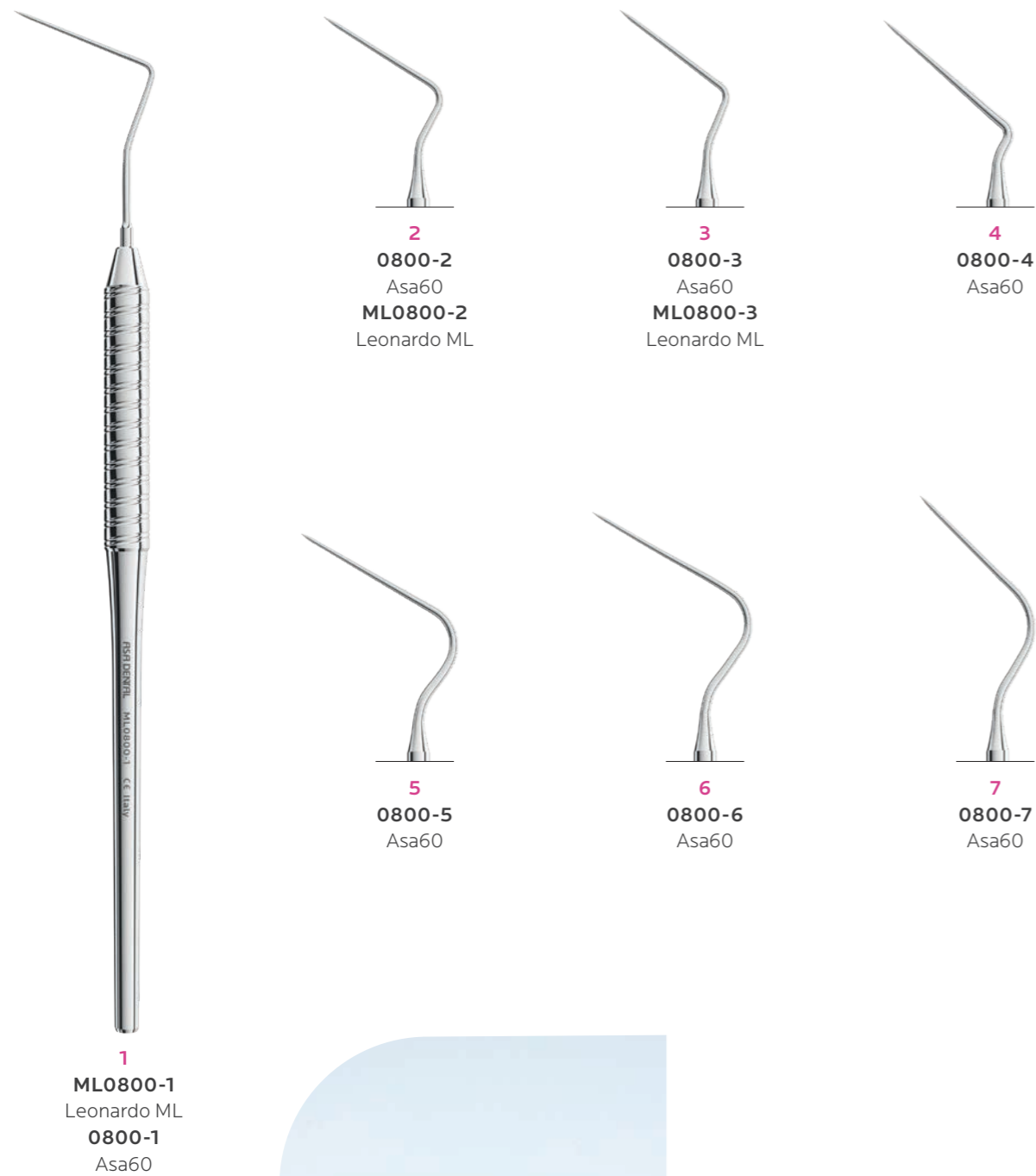

0800-1

Strumenti per trattamenti canalari

Questi strumenti sono dotati di un rivestimento che consente alle punte di svolgere la loro funzione senza alcuna aderenza, qualunque sia la condizione operativa e la pressione applicata.

OTTURATORI PER CANALI



OTTURATORI PER CANALI



7 ½ Schilder
ML0802-1
Leonardo ML



8 Schilder
ML0802-2
Leonardo ML



8 ½ Schilder
ML0802-3
Leonardo ML



9 Schilder
ML0802-4
Leonardo ML



9 ½ Schilder
ML0802-5
Leonardo ML



10 Schilder
ML0802-6
Leonardo ML



10 ½ Schilder
ML0802-7
Leonardo ML



10 Schilder
ML0802-10
Leonardo ML



11 Schilder
ML0802-8
Leonardo ML



11 ½ Schilder
ML0802-9
Leonardo ML

CONDENSATORI



1
0802L-1
Asa60



2
0802L-2
Asa60



3
0802L-3
Asa60



4
0802L-4
Asa60

ESCAVATORI CANALARI



31L
1709-31L
Asa60
MV1709-31L
Asa Light MV



32L
1709-32L
Asa60
MV1709-32L
Asa Light MV



33L
1709-33L
Asa60
MV1709-33L
Asa Light MV

MISURATORE PER STRUMENTI CANALARI

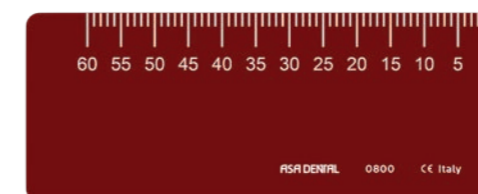

0800

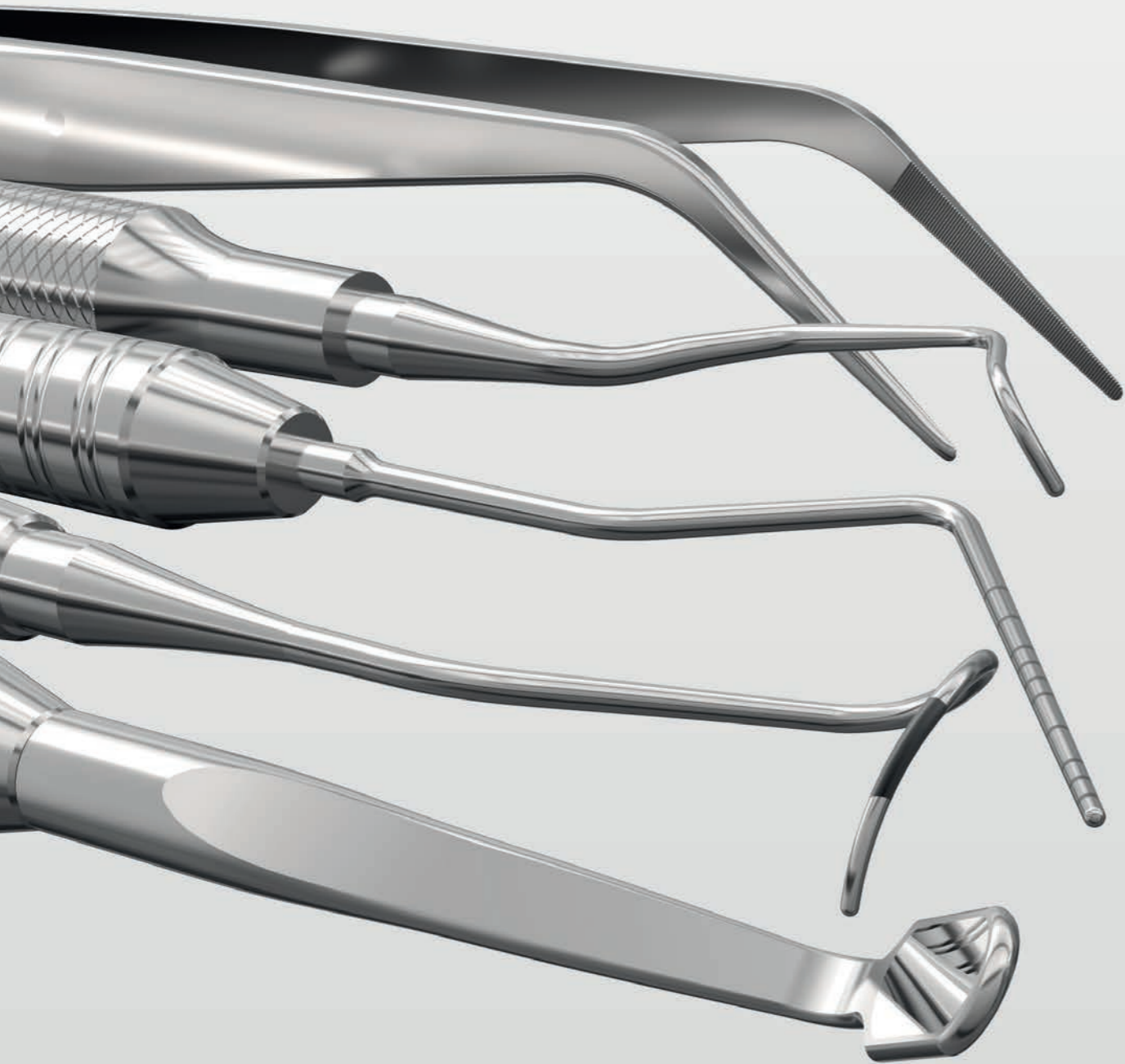

SPECCHIETTI PER FOTOGRAFIE IN VETRO

Superfici occlusali



Superfici buccali



Superfici linguali



SPECCHIETTI PER BOCCA

Scatola da 12



4
Ø 22 mm
piano
2220E-4



4
Ø 22 mm
piano
2200E-4



5
Ø 24 mm
piano
2200E-5



6
Ø 26 mm
piano
2200E-6

Scatola da 12



5
Ø 24 mm
piano
2220E-5



4
Ø 22 mm
concavo
2201E-4



5
Ø 24 mm
concavo
2201E-5

Scatola da 12



5
Ø 22 mm
piano
2221-4



5
Ø 24 mm
piano
2221-5

scatola da 6



5
Ø 24 mm
piano
doppio lato
2230-5

SPECCHIETTI PER BOCCA

Singolo



parallelizzatore
2002-6
parallelizzatore +
manico
S2002-6
Asa60



Ø 3 mm
piano
micro
2240-1



Ø 5 mm
piano
micro
2240-2



7x2 mm
piano
micro
2240-3



9x3 mm
piano
micro
2240-4



6x3 mm
piano
micro
2241-5

MANICI PER SPECCHIETTI



S2101
Asa60
set da 5

S2100
Ottagonale
set da 5

S2102-IN
Esagonale
vuoto
set da 5

ML2101
Leonardo
ML

2104-B
Alu80

2104-C
Alu80

2104-G
Alu80

2104-R
Alu80

2104-V
Alu80

RC2101
AsaWave
RC

SPECCHIETTI PER BOCCA - MODELLO AMERICANO

Cone socket

Scatola da 12



4
Ø 22 mm
2210E-4
piano

5
Ø 24 mm
2210E-5
piano

4
Ø 22 mm
2211E-4
concavo

5
Ø 24 mm
2211E-5
concavo

Scatola da 6



5
Ø 24 mm
piano
doppio lato
2231-5CS

MANICI
Cone socket



2100-CS
Ottagonale



2101-CS
Asa60



2102-CS
Esagonale

SPECCHIETTI ULTRALIGHT

Dati tecnici:

lampadine Philips miniature
infrangibili da 2,25 V - 0,25 A
2 batterie alcaline tipo AAA da 1,5 V

ricambi:

0690-G guarnizione

0690-L luce

0690-M molla

0690-T testa con mandrino

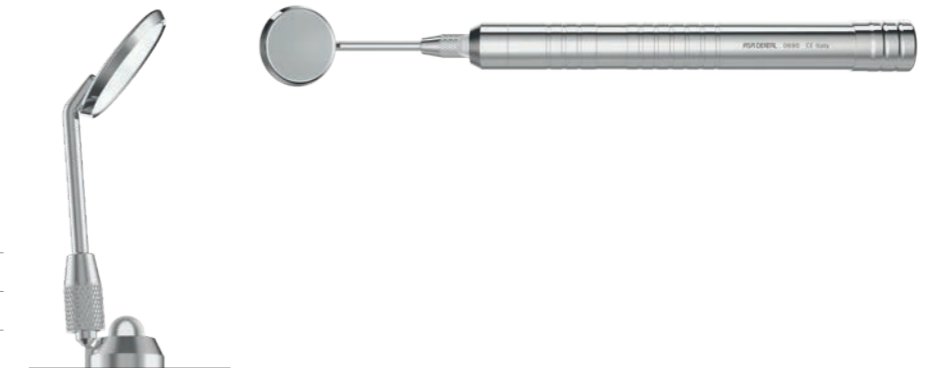

17 cm
0690

DIVARICATORI ULTRALIGHT

Dati tecnici:

lampadine Philips miniature
infrangibili da 2,25 V - 0,25 A
2 batterie alcaline tipo AAA da 1,5 V



14 cm
0691

KIT ULTRALIGHT

con specchietto e divaricatore in un locking tray mini:

0690 specchietto ultralight

0691 divaricatore ultralight

2772-1 locking tray mini

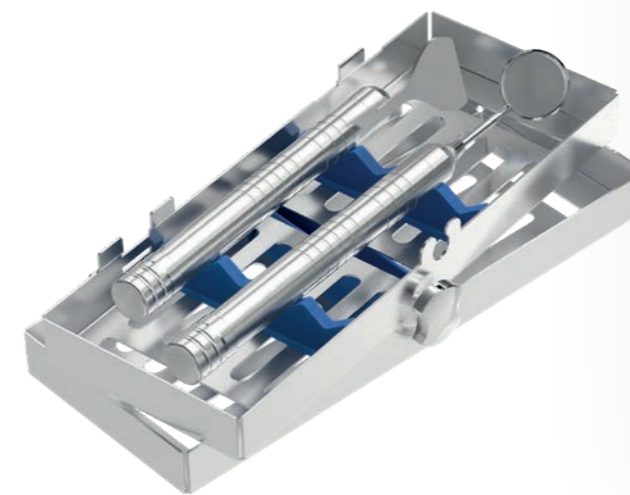

S0690-2

Come usare lo specchietto Ultralight e il divaricatore ultralight:

- inserire 2 batterie alcaline
- togliere le batterie prima della sterilizzazione
- guarnizione interna sterilizzabile posta sulla lampadina che evita l'infiltrazione di saliva o liquidi in genere all'interno del manico preservando così l'integrità delle batterie
- facilità di accensione e spegnimento grazie al tappo posteriore dello strumento che funziona da pratico interruttore
- nessun tipo di manutenzione delle parti elettriche o meccaniche
- completamente smontabile per una corretta pulizia
- facilità nella sostituzione delle lampadine e delle batterie
- impugnatura ergonomica

KIT STRUMENTI PRIMA VISITA



S0600-6

0700-6	sonda con manico anatomico	6
0601-2	pinzetta per medicazioni London-College	2
2101	manico per specchietto anatomico	
2200-4	specchietto piano	4



S0600-9

0700-9	sonda con manico anatomico	9
0601-2	pinzetta per medicazioni London-College	2
2101	manico per specchietto anatomico	
2200-4	specchietto piano	4



S0600-23

0700-23	sonda con manico anatomico	23
0601-2	pinzetta per medicazioni London-College	2
2101	manico per specchietto anatomico	
2200-4	specchietto piano	4

KIT STRUMENTI PRIMA VISITA - ASALADY



SWML0600-6

WML0700-6	sonda con manico anatomico	6
W0610-2	pinzetta per medicazioni London-College	2
WML2101	manico Leonardo per specchietto	
2200-4	specchietto piano	4



SWML0600-9

WML0700-9	sonda con manico anatomico	9
W0610-2	pinzetta per medicazioni London-College	2
WML2101	manico Leonardo per specchietto	
2200-4	specchietto piano	4



SWML0600-23

WML0700-23	sonda con manico anatomico	23
W0610-2	pinzetta per medicazioni London-College	2
WML2101	manico Leonardo per specchietto	
2200-4	specchietto piano	4

KIT STRUMENTI PRIMA VISITA - ASAWAVE



SRC0600-6

RC0700-6	sonda con manico AsaWave	6
0601-2	pinzetta per medicazioni London-College	2
RC2101	manico AsaWave per specchietto	
2200-4	specchietto piano	4



SRC0600-9

RC0700-9	sonda con manico AsaWave	9
0601-2	pinzetta per medicazioni London-College	2
RC2101	manico AsaWave per specchietto	
2200-4	specchietto piano	4



SRC0600-23

RC0700-23	sonda con manico AsaWave	23
0601-2	pinzetta per medicazioni London-College	2
RC2101	manico AsaWave per specchietto	
2200-4	specchietto piano	4



KIT PER ENDODONZIA



Set da 6 strumenti
S0800

AL2746-1	pulitore in alluminio anodizzato per strumenti canalari	
0800	misuratore per strumenti canalari	
0601-2	pinzetta per medicazione London-College	
2101	manico per specchietto anatomico	
2200-4	specchietto piano	4
0710-6D1	sonda per canali	6/1
1709-31L	escavatore canalare	31L
0800-1	condensatore	1
S2702	vassoio forato completo di griglia	



Set da 7 strumenti
(incisione laser)
S0702L-7

0702L-12S	sonda millimetrica O.M.S. punta colorata (incisione laser)	CP-12S
0702L-12	sonda millimetrica punta colorata (incisione laser)	CP-12
0703L-1	sonda millimetrica Williams (incisione laser)	
0703L-4	sonda millimetrica Goldman-Fox (incisione laser)	
0706L-2312	combinazione sonda/sonda millimetrica (incisione laser)	23/CP-12
0802L-1	condensatore (incisione laser)	1
0802L-2	condensatore (incisione laser)	2
0800	misuratore per strumenti canalari	
S2702	vassoio forato completo di griglia	

KIT PER ENDODONZIA

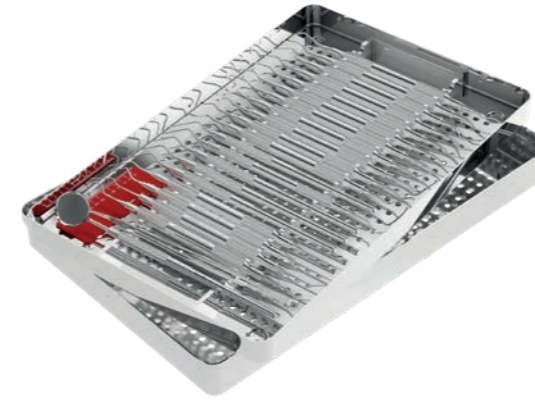

Set da 23 strumenti
"Boston University"
S0702L-23

0601-2	pinzetta per medicazioni London-College	2
2101	manico per specchietto anatomico	
2200-4	specchietto piano	4
0800	misuratore per strumenti canalari	
MV0704-23D1	sonda doppia Asa Light	23/17
MV0710-6D1	sonda per canali Asa Light	6/1
MV0705-16W	combinazione sonda/sonda millimetrica Asa Light Williams	16
MV0705-3GF	combinazione sonda/sonda millimetrica Asa Light Goldman-Fox	3
0702L-12S	sonda millimetrica O.M.S. punta colorata (incisione laser)	CP-12S
0702L-12	sonda millimetrica punta colorata (incisione laser)	CP-12
0702L-11	sonda millimetrica punta colorata (incisione laser)	CP-11
0706L-2312	combinazione sonda/sonda millimetrica (incisione laser)	23/CP-12
0800-1	condensatore	1
MV1709-32L	escavatore canalare Asa Light	32L
MV1706-19	escavatore doppio Asa Light	19
MV1703-14	escavatore doppio Asa Light	14
MV1701-1	escavatore doppio Asa Light	1
MV1807-02	curette Gracey Asa Light	1/2
MV1807-04	curette Gracey Asa Light	3/4
MV1807-06	curette Gracey Asa Light	5/6
MV1807-08	curette Gracey Asa Light	7/8
MV1807-10	curette Gracey Asa Light	9/10
MV1807-12	curette Gracey Asa Light	11/12
MV1807-14	curette Gracey Asa Light	13/14
S2722-2	vassoio forato completo di griglia	2

CHIRURGIA ORALE

MADE IN ITALY



LA PRECISIONE CHIRURGICA: NECESSARIA E INDISPENSABILE

Ogni esperto del settore ha la consapevolezza che quanto più un intervento è invasivo, tanto maggiore è il bisogno di spiegarlo con chiarezza al paziente. La sicurezza del paziente, la sua rassicurazione e la gestione del caso clinico diventano elementi fondamentali quanto l'esecuzione della procedura stessa. Attraverso la combinazione delle proprie abilità settoriali e dei nostri strumenti di precisione, il professionista assicura al paziente i migliori risultati nel minor tempo possibile. A tal proposito, lavoriamo costantemente per soddisfare le richieste di specialisti che esigono strumenti affidabili, capaci di ridurre la complessità dell'intervento e di prevenire qualsiasi tipo di complicazione.

- C3 Forbicine
- C10 Porta aghi
- C20 Pinze emostatiche
- C24 Bisturi
- C28 Siringhe dentali
- C31 Pinze per pannilino
- C32 Pinze porta tamponi
- C33 Apribocca
- C33 Pinze tirlingua
- C34 Divaricatori
- C37 Sonde seno mascellare
- C38 Pinzette chirurgiche
- C44 Cannule per aspirazione
- C45 Cucchiari alveolari
- C46 Kit



MANICI

PUNTA DOPPIA

Asa60

(acciaio inox)
ø 6,0 mm



Asa Light MV

(acciaio inox, vuoto)
ø 8,0 mm



Leonardo ML

(acciaio inox)
ø 7,0 mm

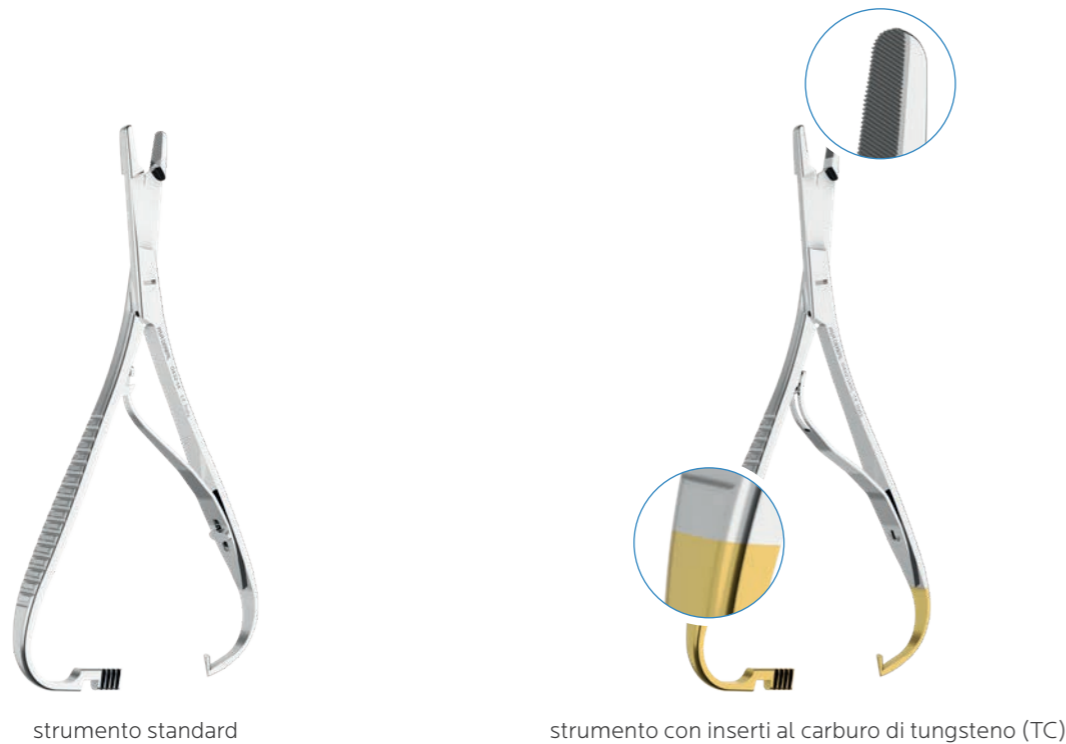

strumento standard

strumento con inserti al carburo di tungsteno (TC)

COME USARE LE INFORMAZIONI

- 1 Hemingway → modello + nome scientifico
- ML2000-1 → codice Asa Dental
- Leonardo ML → manico

AsaLady

prodotti ergonomici progettati su misura per le mani femminili:

- manici ridotti e più leggeri
- anelli delle dita più piccoli
- dimensioni ridotte

codici con prefissi "W" o "SW"

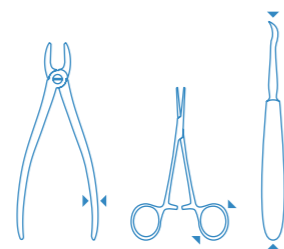

questi prodotti non sono realizzati da Asa Dental e vengono commercializzati con il marchio del produttore



vista dall'alto vista laterale

FORBICINE PER GENGIVE



1
retta
12 cm
0300-1

2
curva
12 cm
0300-2

1
retta
12 cm
W0319-1

2
curva
12 cm
W0319-2



1
angolare
11,5 cm
0301-1

1
angolare
una punta dentata
11,5 cm
0301-2

1 Goldman-Fox
retta
una punta dentata
13 cm
0304-1

2 Goldman-Fox
curva
una punta dentata
13 cm
0304-2

FORBICINE PER GENGIVE



1 Iris
retta
11,5 cm
0305-1



2 Iris
curva
11,5 cm
0305-2



1TC Iris
retta
11,5 cm
0305-1TC

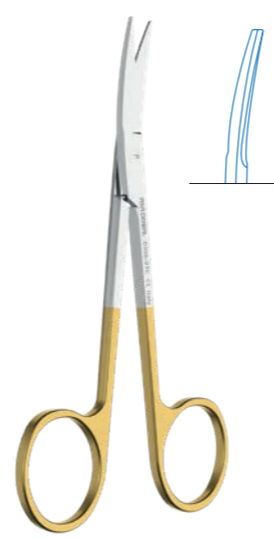

2TC Iris
curva
11,5 cm
0305-2TC



3 Iris
curva
11,5 cm
0305-3



1 Quinby
retta
13 cm
0308-1



2 Quinby
curva
13 cm
0308-2



3 Goldman-Fox (special)
curva
una punta dentata
13 cm
0304-3



1TC Goldman-Fox
retta
13 cm
0304-1TC



2TC Goldman-Fox
curva
13 cm
0304-2TC

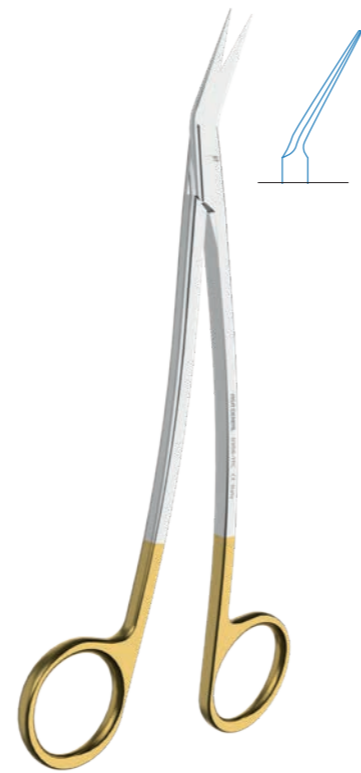

1TC Goldman-Fox
curva
17 cm
0306-1TC

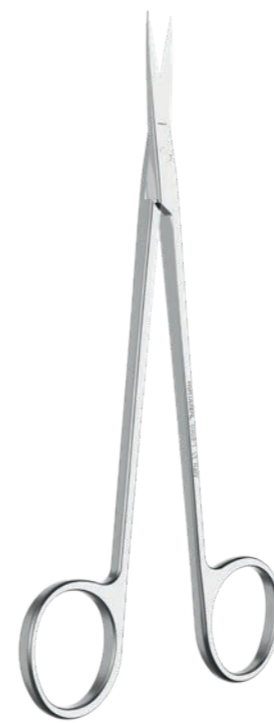

1 Kelly
retta
16 cm
0309-1



2 Kelly
curva
16 cm
0309-2



1TC Kelly
retta
16 cm
0309-1TC



2TC Kelly
curva
16 cm
0309-2TC

FORBICINE PER GENGIVE



1 Sullivan
retta
una punta dentata
14,5 cm
0311-1



2 Sullivan
curva
una punta dentata
14,5 cm
0311-2



1TC Locklin
angolare
16,5 cm
0310-1TC

FORBICINE PER GENGIVE

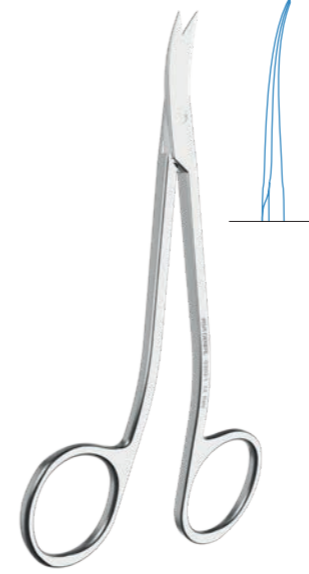

1 Neumann
curva
12,5 cm
0302-1



1 Dean
curva
una punta dentata
17 cm
0306-1

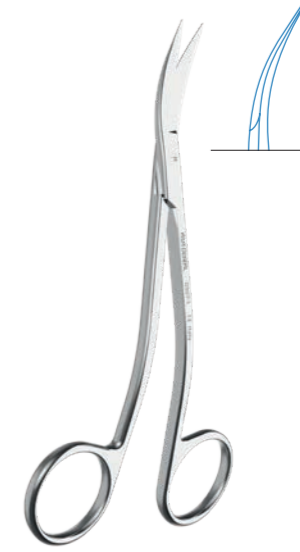

1 La Grange
curva
una punta dentata
12 cm
0307-1



1 Locklin
angolare
una punta dentata
16,5 cm
0310-1



2 Locklin
angolare
una punta dentata
16,5 cm
0310-2



2TC Locklin
angolare
16,5 cm
0310-2TC



1 Noyes (Castroviejo)
curva
punte curve e sottili
11 cm
0303-1

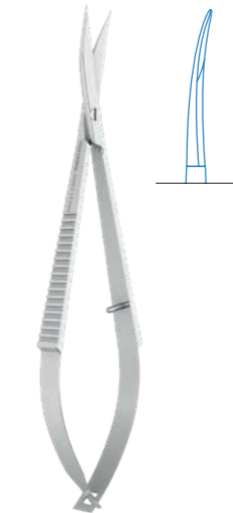

1 Westcott
curva
punte acute
11 cm
0312-1

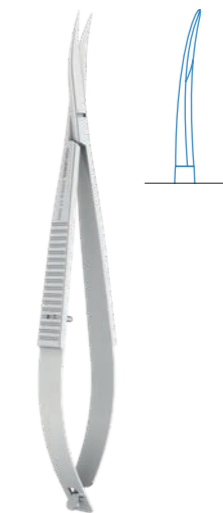

2 Westcott
curva
punte arrotondate
11 cm
0312-2



1
curva
punte curve e sottili
14,5 cm
0313-1

FORBICINE PER GENGIVE

forbicine per sutura

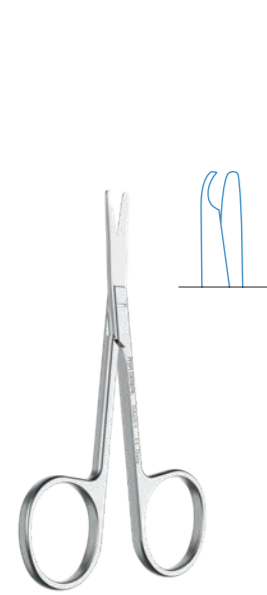

1 Spencer
9 cm
0320-1



2 Spencer
13 cm
0320-2



1 Mayo retta
14,5 cm
0325-1

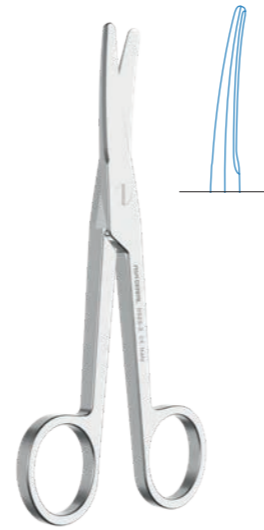

2 Mayo curva
14,5 cm
0325-2



Stevens retta
11,5 cm
0330-1



Stevens curva
11,5 cm
0330-2

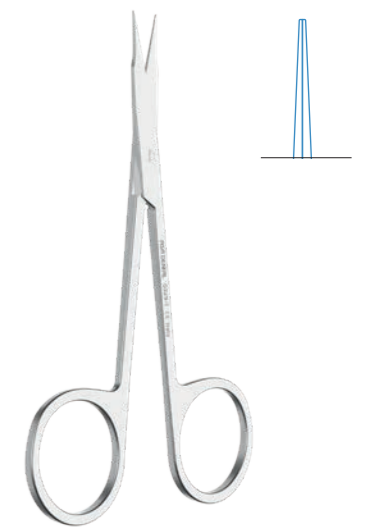

Stevens punte stondate rette
11,5 cm
0329-1

Forbicine per separare



1 Metzenbaum retta
14,5 cm
0321-1



2 Metzenbaum curva
14,5 cm
0321-2



1 Metzenbaum-Delikat retta
14,5 cm
0322-1



2 Metzenbaum-Delikat curva
14,5 cm
0322-2



Stevens retta
11,5 cm
0328-1



Stevens curva
11,5 cm
0328-2

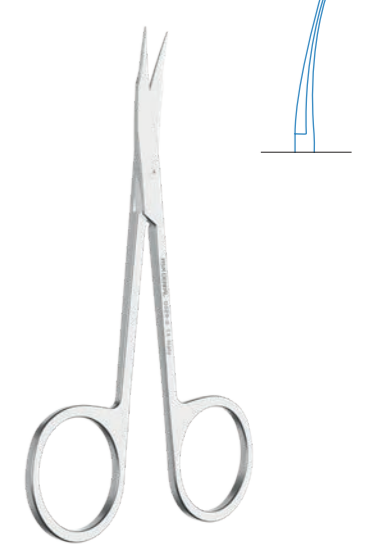

Stevens punte stondate curve
11,5 cm
0329-2

PORTA AGHI



Olsen-Hegar
con forbice
14 cm
0400-14



TC Olsen-Hegar
14 cm
0405-14TC



Crile-Wood
15 cm
0410-15



TC Crile-Wood
15 cm
0415-15TC



Adson
17,5 cm
0403-17



Baumgartner
14,5 cm
0404-14



TC Hegar-Baumgartner
14 cm
0409-14TC



Crile-Wood
15 cm
W0411-15



TC Crile-Wood
15 cm
W0411-15TC

0409-14TC

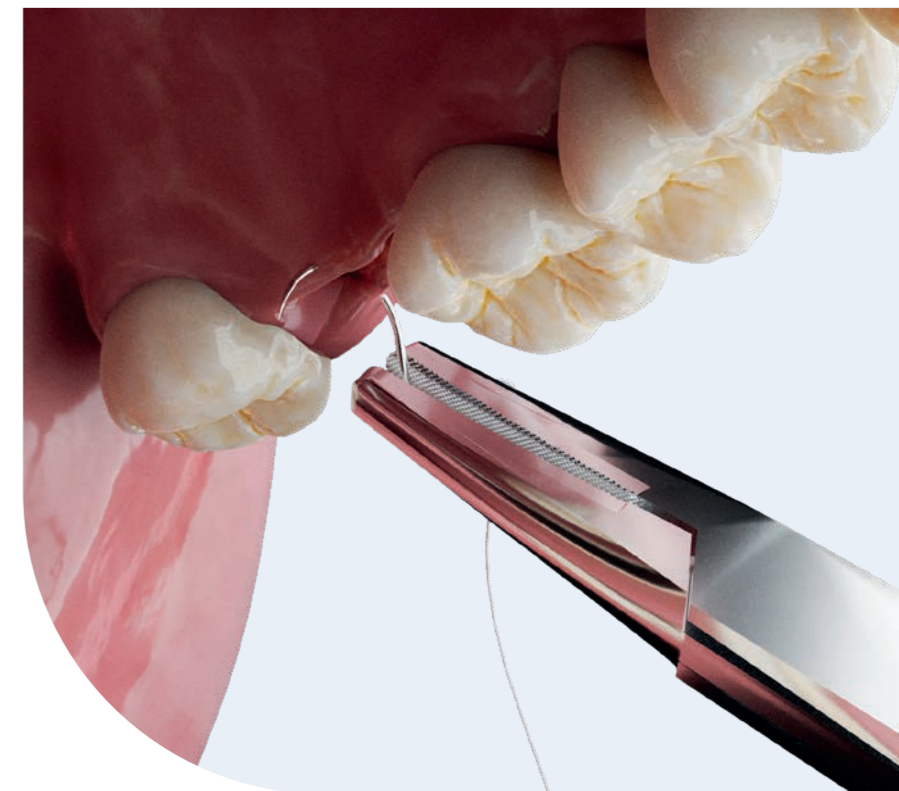

AsaLady

AsaLady

PORTA AGHI



Mayo-Hegar
16 cm
0420-16



TC Mayo-Hegar
16 cm
0425-16TC



Mayo-Hegar
16 cm
W0412-16



Mayo-Hegar
18 cm
0420-18



TC Mayo-Hegar
18 cm
0425-18TC



TC Mayo-Hegar
16 cm
W0412-16TC

PORTA AGHI



Derf
12 cm
0401-12

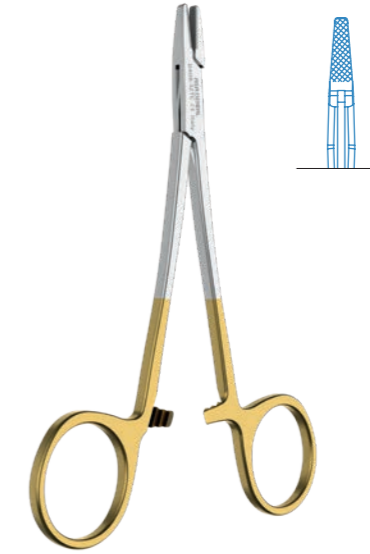

TC Derf
12 cm
0406-12TC

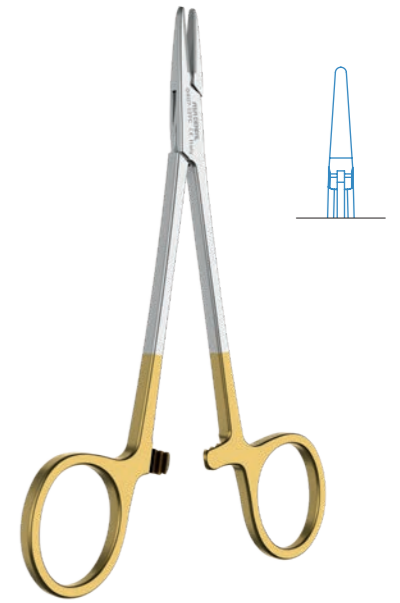

TC Halsey-Smooth
punte lisce
13 cm
0407-13TC

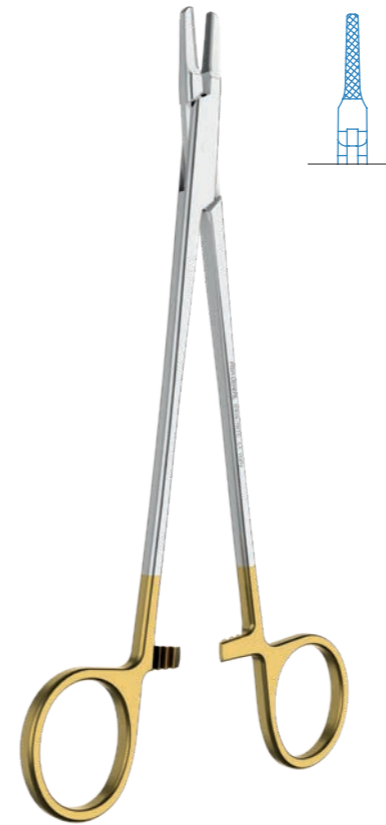

TC Mini-Ryder
18 cm
0416-18TC



TC Mini-Ryder
15 cm
0416-15TC



TC Halsey
13 cm
0408-13TC

PORTA AGHI

PORTA AGHI



Gillies
con forbice
16 cm
0414-16



TC Gillies
con forbice
16 cm
0419-16TC



TC Fine Swedish
15 cm
0417-15TC



Lichtenberg
movimento leggero
17 cm
0432-17



TC Lichtenberg
17 cm
0437-17TC



Eiselberg-Mathieu
19,5 cm
0422-19



Toennis
modello leggero
18 cm
0421-18



TC Toennis
modello leggero
18 cm
0426-18TC



TC Micro-Vascular
15 cm
0418-15TC



Arruga
16 cm
0433-16



TC Arruga
16 cm
0438-16TC

PORTA AGHI

PORTA AGHI

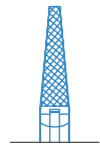

Mathieu
14 cm
0430-14

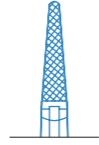

Mathieu
14 cm
0431-14

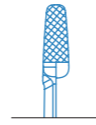

Mathieu
con forbice
14 cm
0432-14

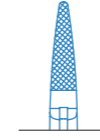

TC Mathieu
14 cm
0435-14TC

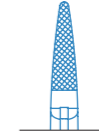

TC Mathieu
14 cm
0436-14TC

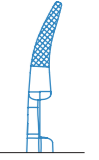

TC Micro-Barraquer
punte curve
18 cm
0451TH-18TC

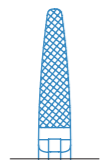

Mathieu
17 cm
0430-17

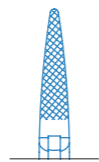

Mathieu
17 cm
0431-17

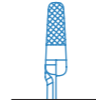

TC Mathieu
14 cm
0432-14TC



TC Mathieu
17 cm
0435-17TC

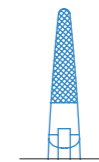

TC Mathieu
17 cm
0436-17TC

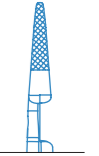

TC Micro-Barraquer
18 cm
0450TH-18TC

PORTA AGHI

PORTA AGHI



TC Castroviejo
punte curve
15,5 cm
PR0460-15TC



Castroviejo
14 cm
0440TH-14



Castroviejo
punte curve
14 cm
0441TH-14



Castroviejo
14 cm / 60°
0443TH-14



Castroviejo
13 cm
0442TH-13



Castroviejo
punte lisce
13 cm
0442TH-13L



Castroviejo-Barraquer
punte lisce
12 cm
0444TH-12L



TC Castroviejo
13 cm
0447TH-13TC



TC Castroviejo
14 cm
0445TH-14TC



TC Castroviejo
14 cm
0446TH-14TC



TC Castroviejo
14 cm / 60°
0448TH-14TC



Castroviejo
18 cm
0440TH-18



Castroviejo
punte curve
18 cm
0441TH-18



TC Castroviejo
18 cm
0445TH-18TC



TC Castroviejo
18 cm
0446TH-18TC

PINZE EMOSTATICHE



1 Crile
retta
14 cm
0520-1



2 Crile
curva
14 cm
0520-2



1 Kocher 1x2
retta
14 cm
0530-1



2 Kocher 1x2
curva
14 cm
0530-2



1 Pean
retta
14 cm
0540-1



2 Pean
curva
14 cm
0540-2

PINZE EMOSTATICHE



1 Halstead-Mosquito
retta
12 cm
0500-1

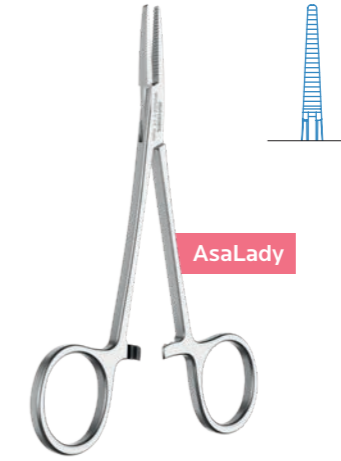

1 Halstead-Mosquito
retta
12 cm
W0502-1



2 Halstead-Mosquito
curva
12 cm
0500-2



2 Halstead-Mosquito
curva
12 cm
W0502-2

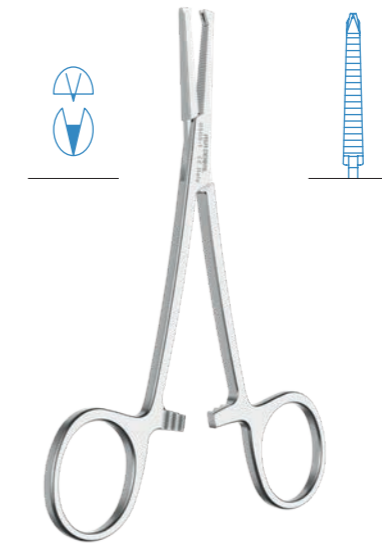

1 Halstead-Mosquito 1x2
retta
12 cm
0505-1

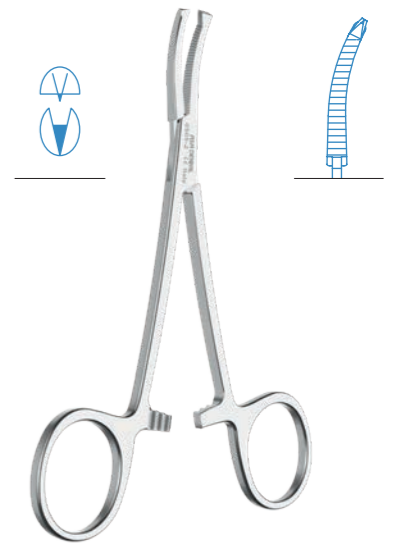

2 Halstead-Mosquito 1x2
curva
12 cm
0505-2

PINZE EMOSTATICHE

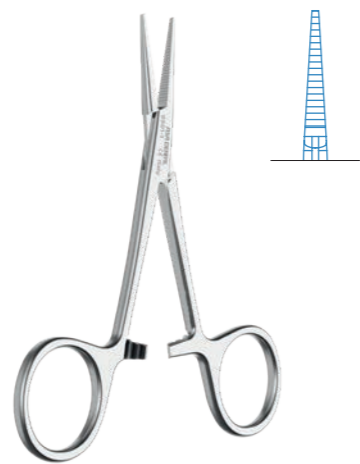

1 Micro-Mosquito
retta
10 cm
0501-1

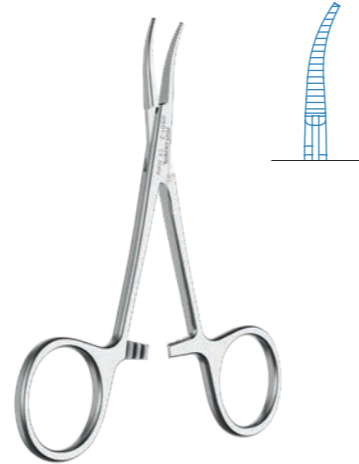

2 Micro-Mosquito
curva
10 cm
0501-2



1 Micro-Mosquito 1x2
retta
10 cm
0506-1

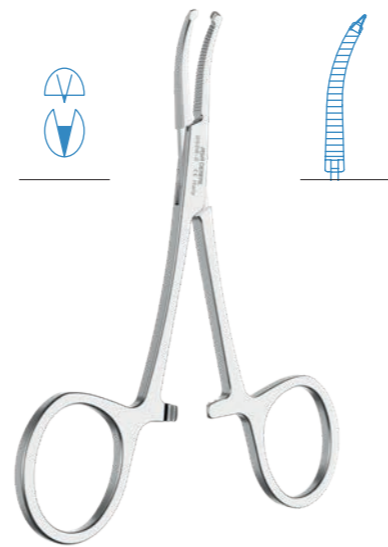

2 Micro-Mosquito 1x2
curva
10 cm
0506-2

PINZE EMOSTATICHE



1 Kelly
retta
14 cm
0510-1



2 Kelly
curva
14 cm
0510-2



1 Hartmann
retta
10 cm
0515-1



2 Hartmann
curva
10 cm
0515-2



MANICI
PER BISTURI
A LAMA
ORIENTABILE



16 cm
0335-1
(coppia di strumenti)

PINZA TOGLI LAMA



16,5 cm
0352



S0352
serie composta da
0352
pinza togli lame +
0335-1
(coppia di strumenti)
manici per bisturi a
lama orientabile

BISTURI MONOUSO 
10 pz / confezione

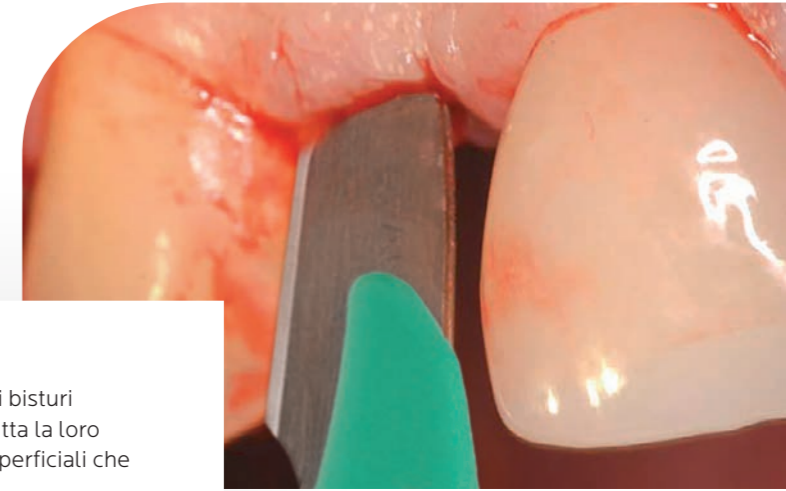

0371-10
Affilate e sottili, le lame dei bisturi monouso mantengono intatta la loro efficacia sia per incisioni superficiali che a livello del periostio.



0371-10



0371-11



0371-12



0371-15

MANICI PER BISTURI

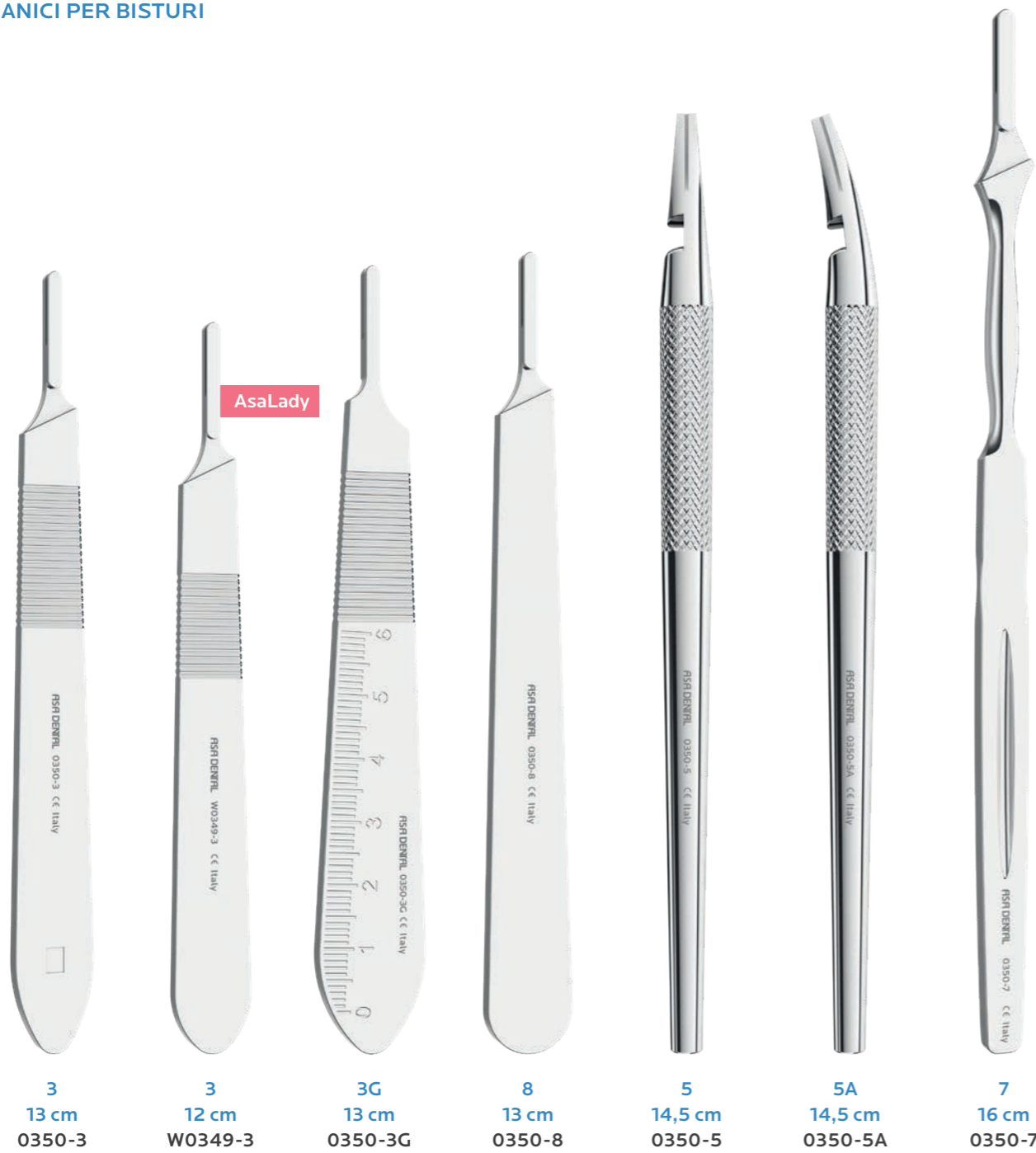

LAME PER BISTURI

100 pz (sterili) / confezione



MANICI PER BISTURI



LAME PER BISTURI

100 pz (sterili) / confezione

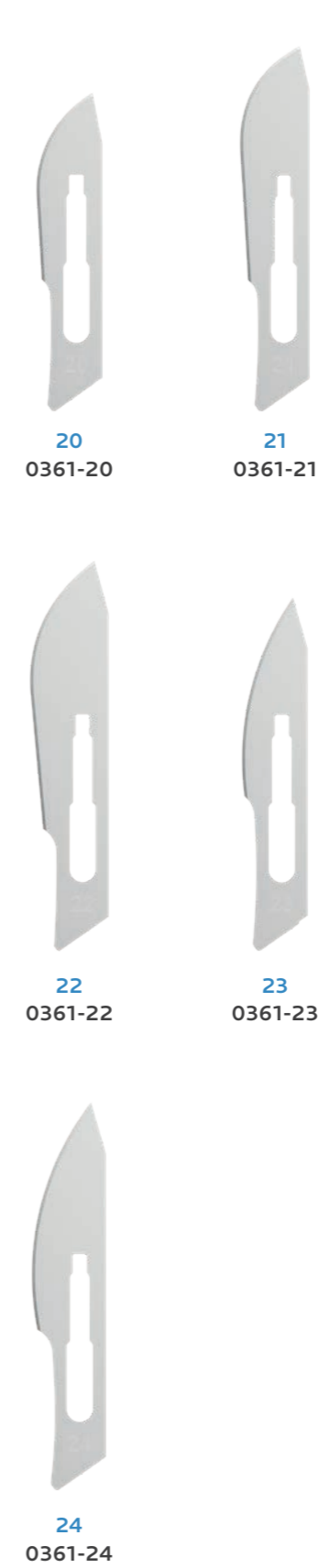

MICRO LAME

25 pz (sterili) / confezione



SIRINGHE DENTALI

non autoaspiranti

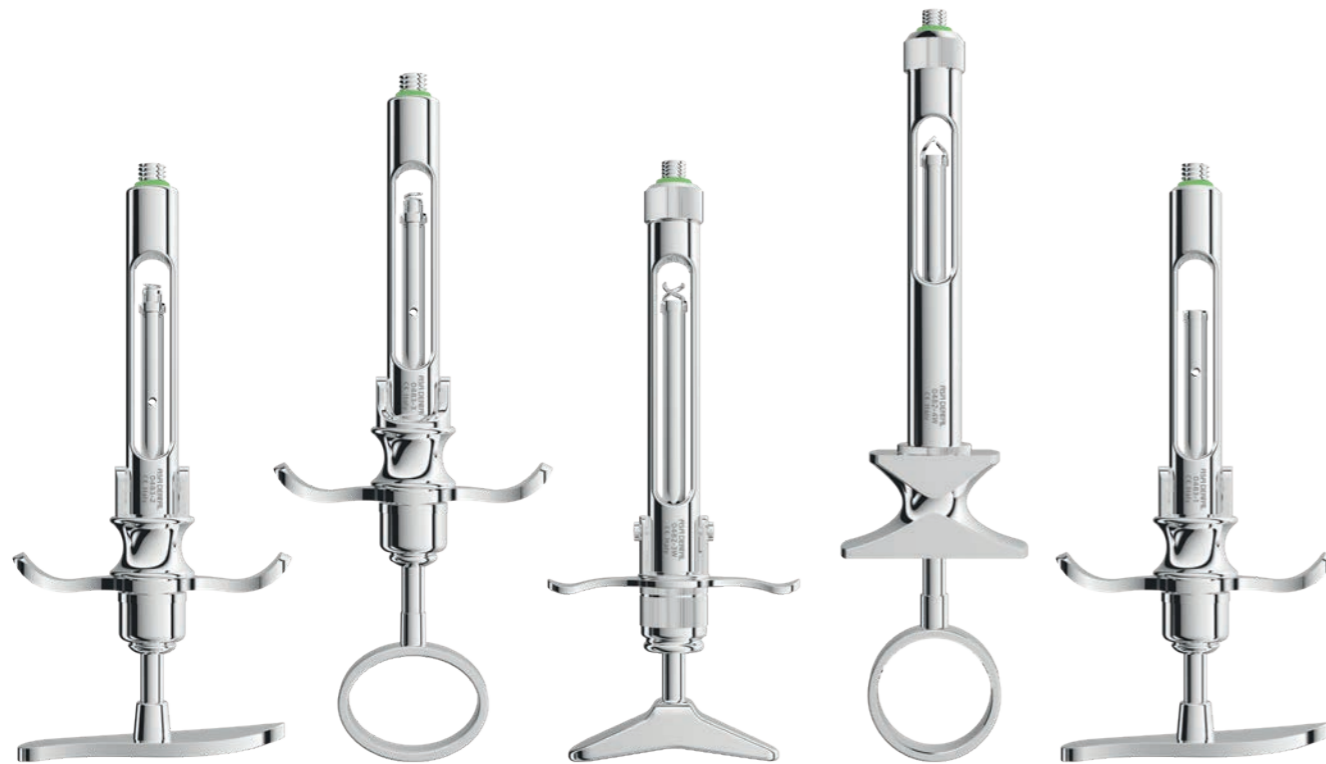

cartuccia da 1,8 ml
filettatura metrico
decimale
0483-2

cartuccia da 1,8 ml
filettatura metrico
decimale
0483-3

cartuccia da 2,2 ml
filettatura Whitworth
0482-3W

cartuccia da 2,2 ml
filettatura imperiale
(Whitworth)
0482-4W

cartuccia da 1,8 ml
filettatura metrico
decimale
0483-1

autoaspiranti



cartuccia da 1,8 ml
filettatura metrico decimale
0480-5

cartuccia da 1,8 ml
filettatura metrico decimale
0480-6

cartuccia da 2,2 ml
filettatura imperiale
(Whitworth)
0482-6W

SIRINGHE DENTALI

puntale a cavatappi



cartuccia da 1,8 ml
filettatura metrico decimale
0480-1

cartuccia da 1,8 ml
filettatura metrico decimale
0480-2

cartuccia da 1,8 ml
filettatura metrico decimale
0480-4

Puntali di ricambio per

- 0480-1
- 0480-2
- 0480-3
- 0480-4

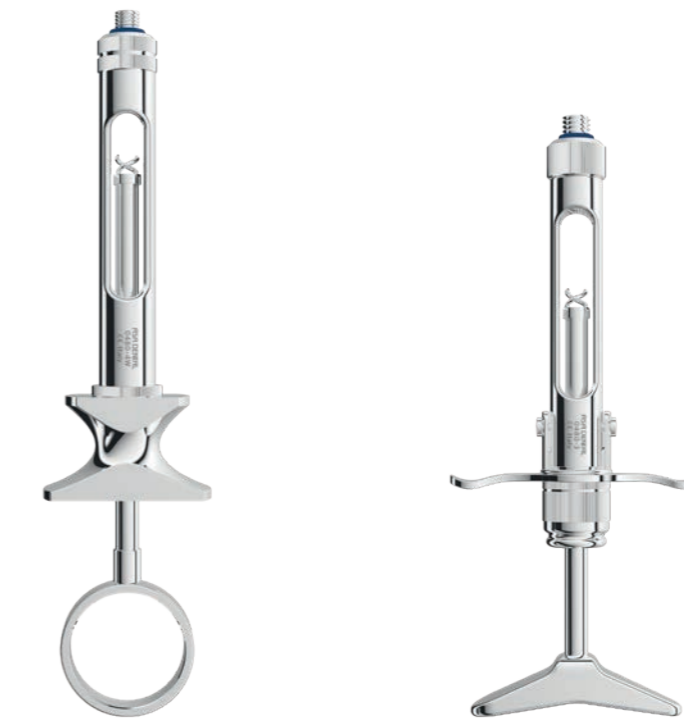

cartuccia da 1,8 ml
filettatura Whitworth
0480-4W

cartuccia da 1,8 ml
filettatura metrico decimale
0480-3



filettatura metrico decimale
0480-P1



filettatura Whitworth
0480-P2

SIRINGHE DENTALI

per anestesia Intraligamentare

Siringa in acciaio inox



cartuccia da 1,8 ml
filettatura metrico decimale
0481-8

**Siringhe in ottone
con parti meccaniche
in acciaio inox**



cartuccia da 2,2 ml
filettatura Whitworth
0482-7W



cartuccia da 1,8 ml
filettatura metrico decimale
0481-7

Protezione in plastica autoclavabile



0481-T1

Base di appoggio per siringa



0482-1

PINZE PER PANNILINO



1 Backhaus
8 cm
0550-1



2 Backhaus
11 cm
0550-2



3 Backhaus
13 cm
0550-3



Schaedle
9 cm
0680



Jones
9 cm
0681

PINZE PORTA TAMPONI



Gross-Maier
retta
20 cm
0555-1



Gross-Maier
retta
25 cm
0557-1



Gross-Maier
curva
20 cm
0555-2



Gross-Maier
curva
25 cm
0557-2

APRIBOCCA

Per adulti



Molt
14 cm
1870-2



Roser-Koenig
19 cm
1871-2

Per bambini



Molt
11 cm
1870-1



Roser-Koenig
16 cm
1871-1

PINZE TIRALINGUA



Collin
16 cm
0560



0561-R

Young
17 cm
0561

DIVARICATORI

Divaricatori per labbra

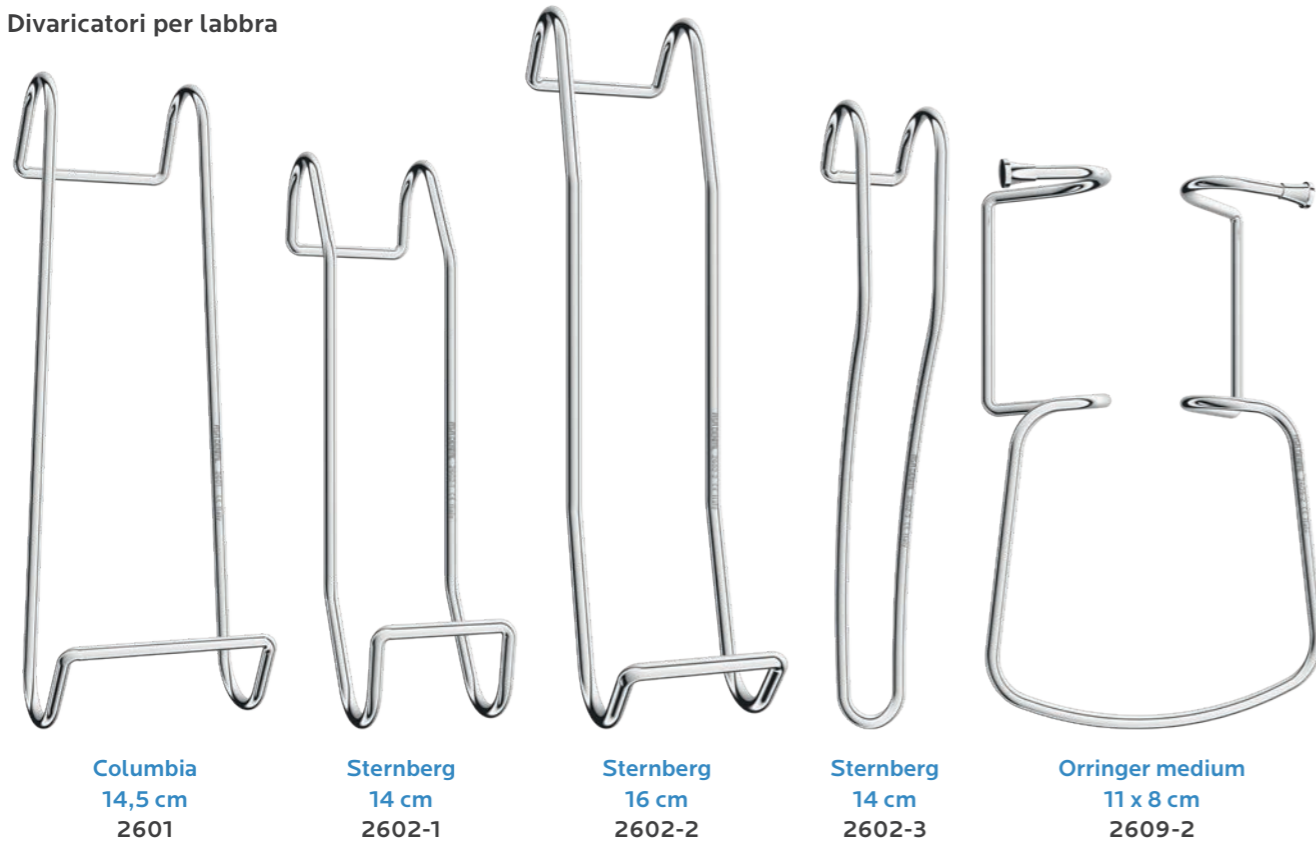

Columbia
14,5 cm
2601

Sternberg
14 cm
2602-1

Sternberg
16 cm
2602-2

Sternberg
14 cm
2602-3

Orringer medium
11 x 8 cm
2609-2

Abbassalingua



14 cm
2605

17 cm
2606

Buchwald
17 cm
2607

Brünings
19 cm
2608

Divaricatore per guance



University of Minnesota
14 cm
2604

DIVARICATORI



arrotondato
16 cm
2611-1

arrotondato
16 cm
2611-2

Senn-Miller
acuto
15,5 cm
2613-1

Senn-Miller
arrotondato
16 cm
2613-2

Kilner
15 cm
2615-1

Farabeuf
13 cm
2616-1



Williger
sinistro
acuto
13 cm
2617-2

Williger
destro
acuto
14 cm
2617-3

Williger
retto
arrotondato
13 cm
2618-1

Williger
sinistro
arrotondato
13 cm
2618-2

DIVARICATORI



Divaricatori per spina nasale



DIVARICATORI

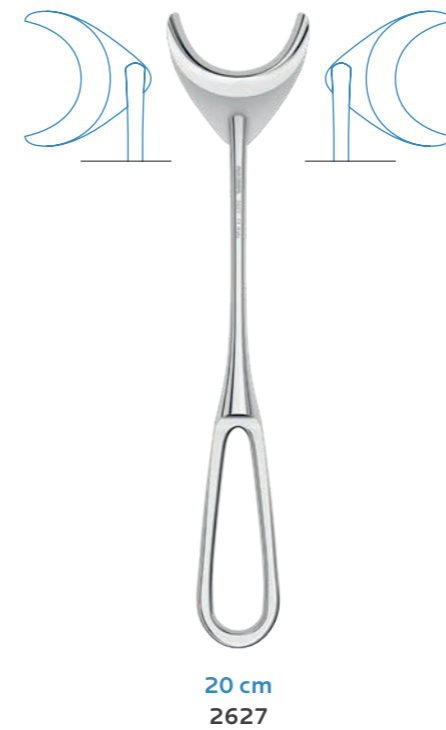

SONDE SENO MASCELLARE

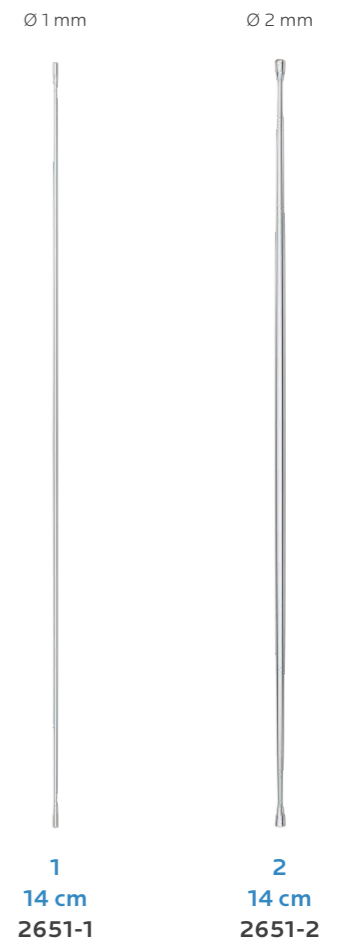

PINZETTE CHIRURGICHE

PINZETTE CHIRURGICHE

PR0632-1

Pinzette chirurgiche atraumatiche con punte sottili

Pinzette ideali per manipolare i tessuti e facilitare le operazioni di sutura in modo semplice e preciso.

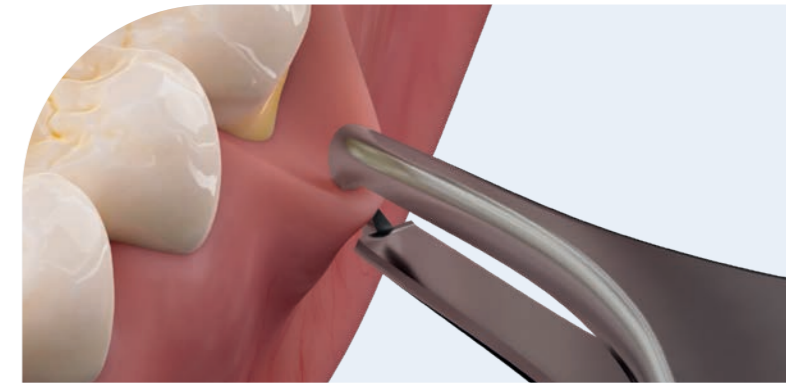

0622-2

0,8 mm



Cooley
17,5 cm
PR0632-1



1 Adson
12 cm
0620-1



1 Adson 1x2
12 cm
0621-1



1 Micro-Adson 1x2
12 cm
0622-1



2 Micro-Adson 1x2
15 cm
0622-2



10 cm
0623-1



Micro-Adson
12 cm
0624-1



Micro-Adson
15 cm
0624-2

PINZETTE CHIRURGICHE

pinzette per sutura

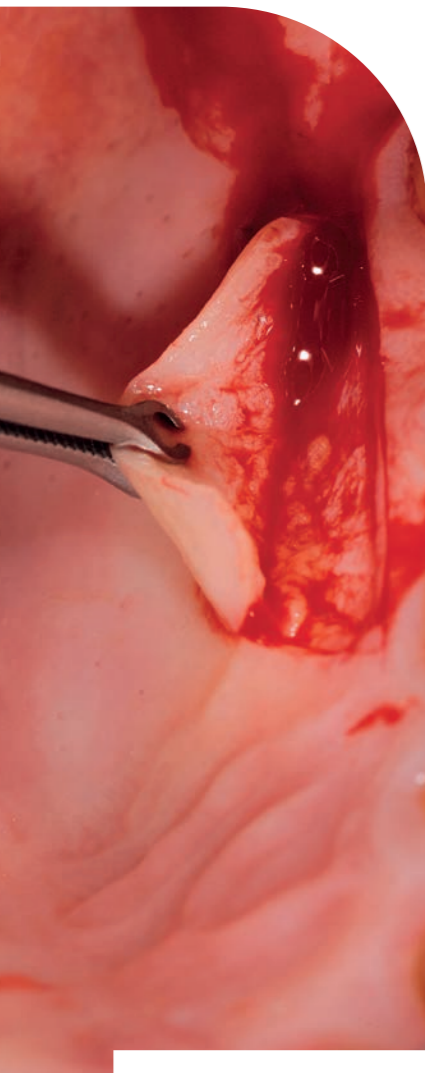

PR0625-3

Consente la manipolazione atraumatica del lembo chirurgico e facilita la sutura.



PINZETTE CHIRURGICHE

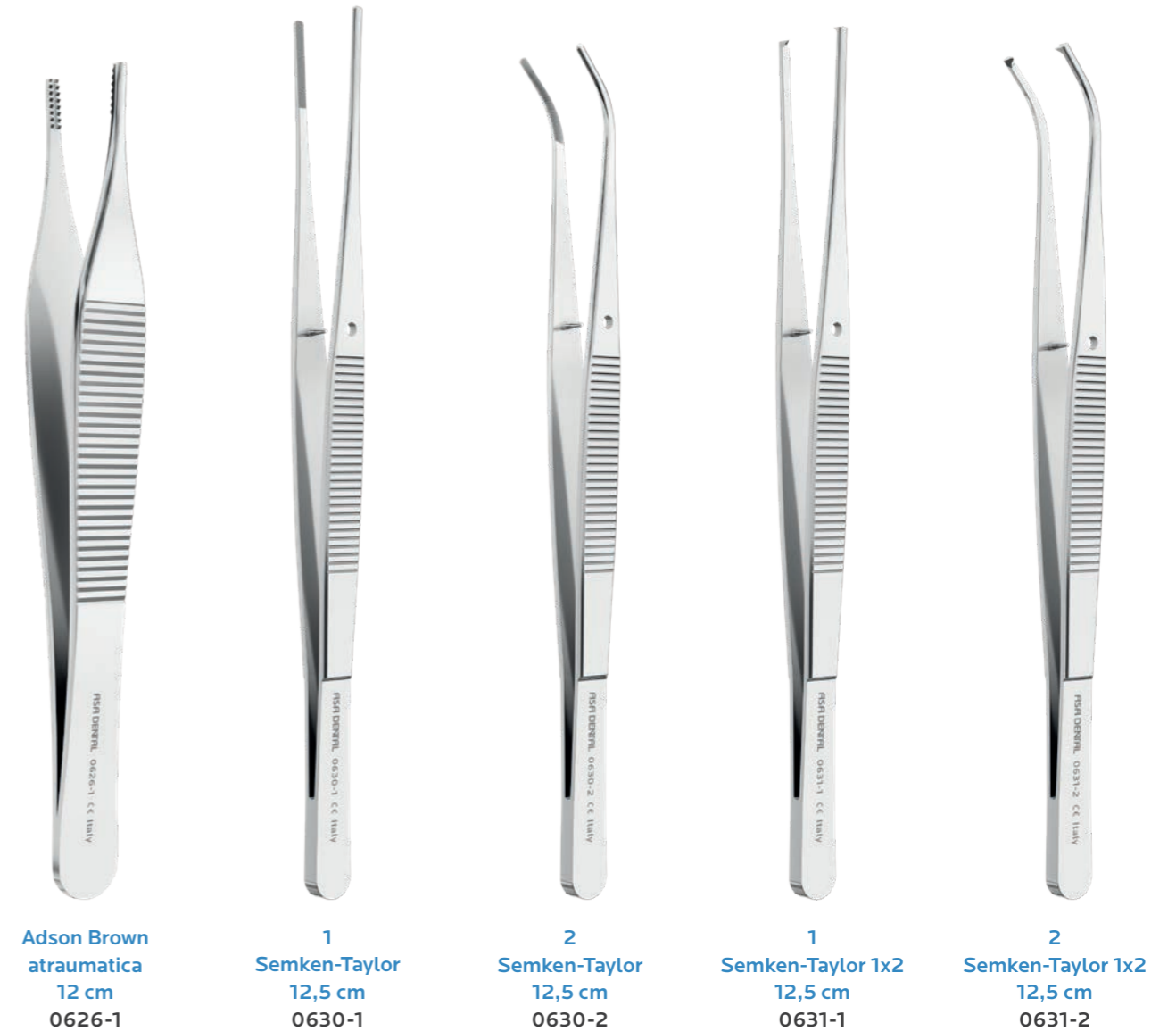
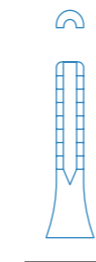

PINZETTE CHIRURGICHE

punte molto fini

Set da 5



1 · 2 · 3 · 4 · 5
S0645



1
12,5 cm
0645-1



2
12 cm
0645-2



3
11,5 cm
0645-3



4
11,5 cm
0645-4



5
11,5 cm
0645-5



1
13 cm
0635-1



2
14 cm
0635-2



3
15 cm
0635-3



4
18 cm
0635-4



5
20,5 cm
0635-5

PINZETTE CHIRURGICHE

CANNULE CHIRURGICHE IN ACCIAIO INOX



CUCCHIAI ALVEOLARI

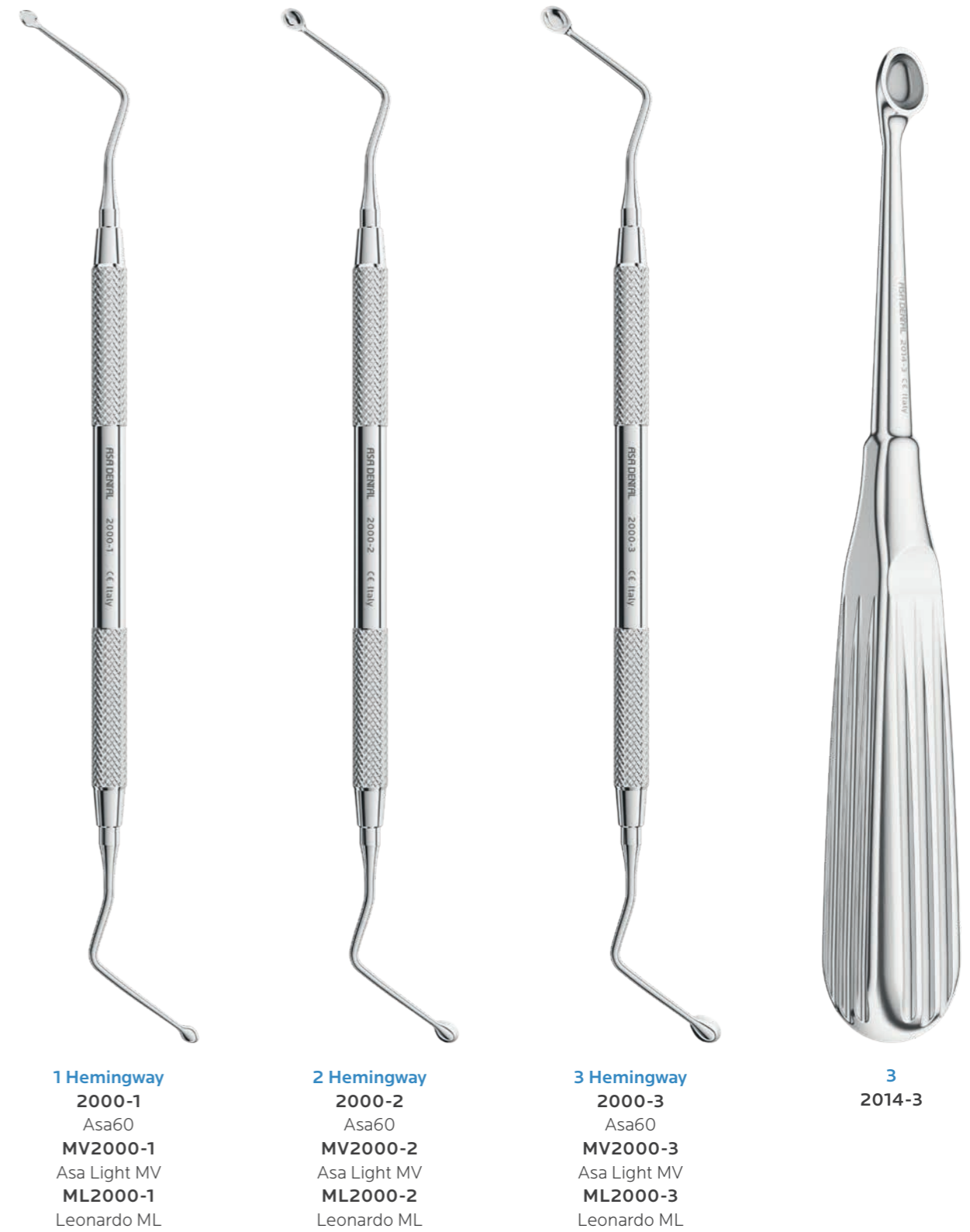

KIT DI STRUMENTI PER CHIRURGIA ORALE

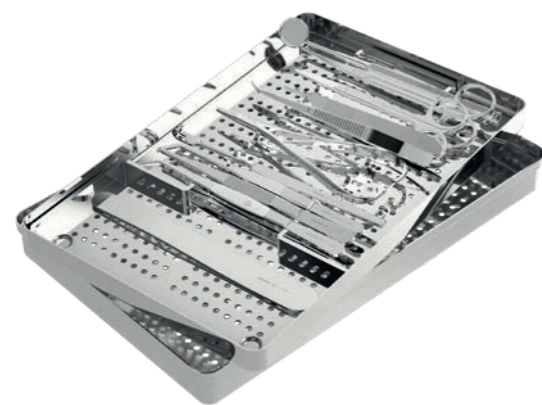

S3002-13

0602-2	pinzetta per medicazioni	2
0635-3	pinzetta chirurgica	3
0625-1	pinzetta per sutura	1
2611-2	divaricatore	
0430-14	porta aghi Mathieu	
0441TH-14	porta aghi Castroviejo	
0350-3	manico per bisturi	
0320-2	forbicina per chirurgia Spencer retta	
0321-2	forbicina per chirurgia Metzenbaum curva	2
2102-IN	manico per specchietti	
2607	divaricatore Buchwald	
2200-4	specchietto piano	4
S2722-1	vassoio forato completo di griglia	

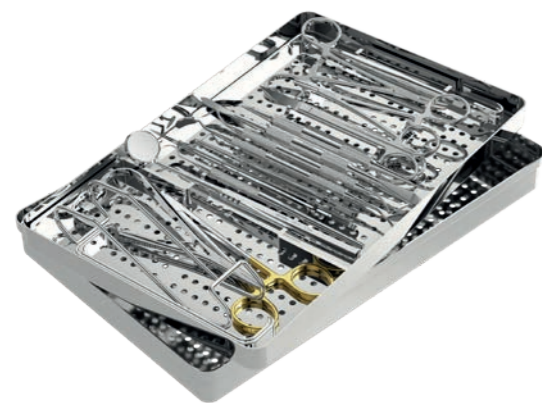

S3002-17

2102-IN	manico per specchietti	
0700-23	sonda manico anatomico	23
0601-2	pinzetta per medicazioni London-College	2
0631-1	pinzetta chirurgica Semken-Taylor	1
1815-7	bisturi Goldman-Fox	7
1804-D	bisturi Orban	1/2
MV1850-M9	scollaperiostio Molt	M9
MV1851-PR3	scollaperiostio Prichard	PR3
2616-1	divaricatore Farabeuf	
2602-1	divaricatore Sternberg	
2613-2	divaricatore Senn-Miller	
0415-15TC	porta aghi Crile-Wood	
0430-14	porta aghi Mathieu	
0304-2	forbicina Goldman-Fox curva	2
0500-1	pinza emostatica Halstead-Mosquito retta	1
0500-2	pinza emostatica Halstead-Mosquito curva	2
2200-5	specchietto piano	5
S2722-1	vassoio forato completo di griglia	

KIT DI STRUMENTI PER CHIRURGIA ORALE

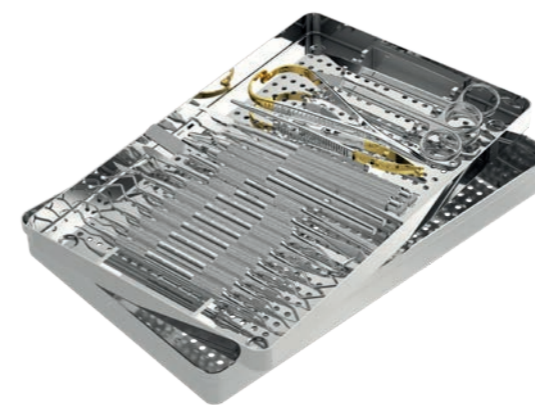

S3002-18

MV1807-08	curette Gracey	7/8
MV1807-12	curette Gracey	11/12
MV1807-14	curette Gracey	13/14
0304-1	forbicina Goldman-Fox retta	1
0304-2	forbicina Goldman-Fox curva	2
MV2001-85	cucchiaio alveolare Lucas	85
MV2001-86	cucchiaio alveolare Lucas	86
MV1803-D	bisturi Kirkland	1/2
MV1804-D	bisturi Orban	1/2
MV1850-M9	scollaperiostio Molt	M9
MV1851-PR3	scollaperiostio Prichard	PR3
0350-5	manico per bisturi retto	5
0350-5A	manico per bisturi curvo	5A
1800-1	scalpello Ochsenbein	1
1800-2	scalpello Ochsenbein	2
0445TH-14TC	porta aghi Castroviejo	
0435-14TC	porta aghi Mathieu	
S2722-2	vassoio forato completo di griglia	

CHIRURGIA ESTRATTIVA

MADE IN ITALY



RISOLVERE IL PRESENTE, PROGETTANDO IL FUTURO

L'estrazione di un dente è sempre considerata una misura estrema, spesso dettata da una condizione di dolore per il paziente. Anche le estrazioni più semplici comportano manovre attente e scrupolose, al fine di preservare l'osso e di non compromettere futuri interventi di chirurgia implantare.

Tuttavia, l'esperienza dei professionisti e la letteratura medica riportano casi che presuppongono procedure ben più complesse. Un molare spezzato all'altezza della gengiva, un dente del giudizio incluso o semi-incluso, un molare che stenta ad

uscire: l'estrazione si trasforma in un'operazione chirurgica a tutti gli effetti, rivolta a creare un accesso attraverso la gengiva ed a minimizzare la quantità di osso sacrificato. Precisione assoluta e invasività minimale richiedono un ampio range di strumenti dalle caratteristiche superiori, compresa la necessaria varietà di leve, per poter affrontare qualsiasi tipo di intervento.

- | | |
|------------|-----------------------------------|
| D4 | Pinze per estrazione |
| D37 | Pinze per estrazione per bambini |
| D40 | Pinze per radici e frammenti |
| D42 | Pinze ossivore alveolotome |
| D44 | Pinze per tessuti |
| D45 | Leve per radici |
| D46 | Leve lussatrici atraumatiche |
| D64 | Mini-leve per frammenti di radici |
| D67 | Sindesmotomi |
| D70 | Dissettori |
| D70 | Periotomi |
| D71 | Kit per chirurgia |
| D73 | Accessori |



PINZE PER ESTRAZIONE

con profilo ritentivo



S0100-1

0100-1	1
0100-17	17
0100-18	18
0100-79	79
0100-67A	67A
0100-51A	51A
0100-13	13
0100-22	22



1
17,5 cm
0100-1

incisivi e canini superiori



2
17 cm
0100-2

incisivi e canini superiori



3
17 cm
0100-3

incisivi e canini superiori sovrapposti



4
15,5 cm
0100-4

incisivi e canini inferiori



7
16,5 cm
0100-7

incisivi superiori premolari superiori



8
16 cm
0100-8

premolari inferiori

PINZE PER ESTRAZIONE

con profilo ritentivo



S0100-2

0100-1	1
0100-7	7
0100-17	17
0100-18	18
0100-4	4
0100-13	13
0100-22	22
0100-86C	86C



13
16 cm
0100-13

premolari inferiori



17
16 cm
0100-17

molari superiori destri



18
16,5 cm
0100-18

molari superiori sinistri



18A
16,5 cm
0100-18A

molari superiori



20
16 cm
0100-20

denti del giudizio inferiori



21
16 cm
0100-21

molari inferiori

PINZE PER ESTRAZIONE
con profilo ritentivo



19
15 cm
0100-19
denti del giudizio superiori



22
15 cm
0100-22
molari inferiori



22L Routurier
17,5 cm
0100-22L
molari e denti del giudizio inferiori sinistri



22R Routurier
17,5 cm
0100-22R
molari e denti del giudizio inferiori destri



23
15 cm
0100-23
molari inferiori destri



24
15 cm
0100-24
molari inferiori sinistri



29
17,5 cm
0100-29
radici superiori



29N
17,5 cm
0100-29N
radici e incisivi superiori

PINZE PER ESTRAZIONE

con profilo ritentivo



30
17 cm
0100-30
radici superiori



31
16 cm
0100-31
radici e incisivi inferiori

33
15 cm
0100-33
radici inferiori



33A
15 cm
0100-33A
radici inferiori

33L
15 cm
0100-33L
radici inferiori



38A
15 cm
0100-38A
denti inferiori fratturati
o parzialmente rotti

41
19 cm
0100-41
radici superiori

PINZE PER ESTRAZIONE

con profilo ritentivo



43A
16,5 cm
0100-43A
denti superiori fratturati
o parzialmente rotti



0100-45
Pinze con punte curve e
profilo ritentivo indicate per
l'estrazione di radici inferiori.



44
18,5 cm
0100-44
radici superiori

45
18,5 cm
0100-45
radici inferiori



46
18,5 cm
0100-46
radici inferiori

46L
19 cm
0100-46L
radici inferiori

PINZE PER ESTRAZIONE

con profilo ritentivo



48
18,5 cm
0100-48
radici superiori



49
18,5 cm
0100-49
radici superiori



51L
18,5 cm
0100-51L
radici superiori



51
18 cm
0100-51
radici superiori



51A
17,5 cm
0100-51A
radici superiori



51LX
19 cm
0100-51LX
radici superiori

PINZE PER ESTRAZIONE

con profilo ritentivo



52
18 cm
0100-52
radici superiori
e canini

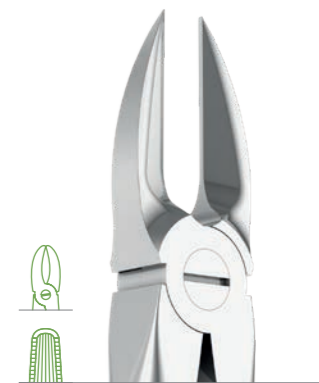

54
17 cm
0100-54
per separare
molari superiori



55
16,5 cm
0100-55
per separare
molari superiori



56
15,5 cm
0100-56
per separare
molari inferiori



59
15 cm
0100-59
radici inferiori



59L
16 cm
0100-59L
radici incisivi inferiori

PINZE PER ESTRAZIONE

con profilo ritentivo



60
15 cm
0100-60
radici inferiori



65L
17 cm
0100-65L
molari superiori sinistri



65R
17 cm
0100-65R
molari superiori destri



66L
17 cm
0100-66L
molari superiori sinistri



66R
17 cm
0100-66R
molari superiori destri



67
18,5 cm
0100-67
denti del giudizio superiori



67A
18,5 cm
0100-67A
denti del giudizio superiori



67 1/2 L
18,5 cm
0100-67/L
denti del giudizio superiori sinistri



67 1/2 R
18,5 cm
0100-67/R
radici incisivi inferiori destri



PINZE PER ESTRAZIONE

con profilo ritentivo

PINZE PER ESTRAZIONE

con profilo ritentivo



68
17,5 cm
0100-68
radici inferiori

73
16 cm
0100-73
molari inferiori



74
16 cm
0100-74
radici inferiori



74M
16 cm
0100-74M
radici inferiori



74N
16 cm
0100-74N
radici inferiori

PINZE PER ESTRAZIONE

con profilo ritentivo



75
16 cm
0100-75
canini e premolari inferiori

79
17 cm
0100-79
denti del giudizio inferiori



79A
17 cm
0100-79A
denti del giudizio inferiori



79C
17 cm
0100-79C
denti del giudizio inferiori

PINZE PER ESTRAZIONE

senza profilo ritentivo



86 1/2L Routurier
17,5 cm
0100-86/L
denti del giudizio inferiori sinistri

86 1/2R Routurier
17,5 cm
0100-86/R
denti del giudizio inferiori destri

86C
16 cm
0100-86C
molari inferiori

PINZE PER ESTRAZIONE

senza profilo ritentivo



86W White
16,5 cm
0100-86W
per lussazione ultimo molare inferiore

87
16 cm
0100-87
molari inferiori cariati
o corone rotte

166 Trotter
17 cm
0100-166
pinza universale per
denti superiori, in particolare
molari e premolari

PINZE PER ESTRAZIONE
con profilo ritentivo



89
18 cm
0100-89
molari superiori destri

90
18 cm
0100-90
molari superiori sinistri

99
16 cm
0100-99
molari inferiori
con corona rotta

PINZE PER ESTRAZIONE
con profilo ritentivo

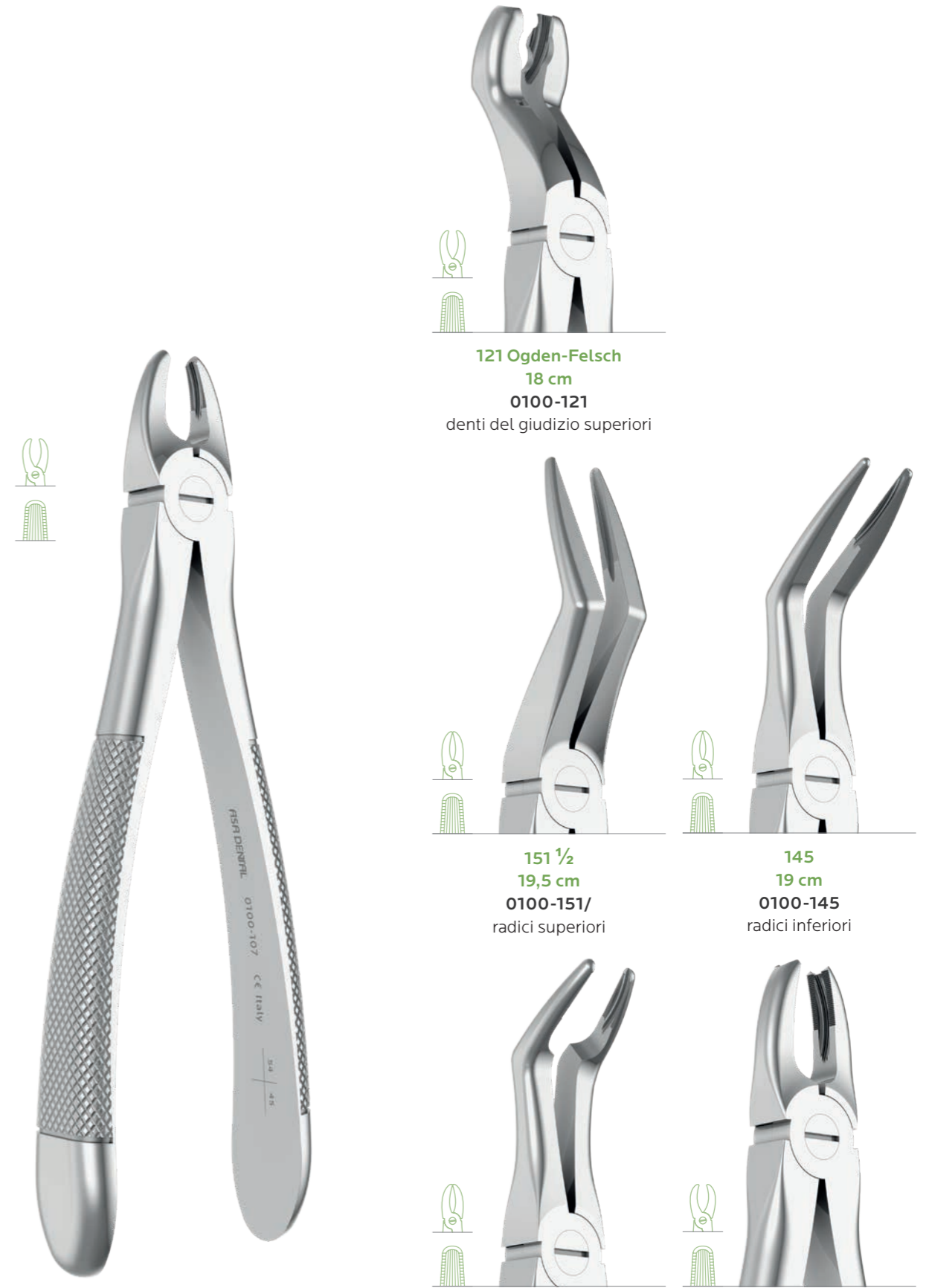

107
16,5 cm
0100-107
canini superiori

121 Ogden-Felsch
18 cm
0100-121
denti del giudizio superiori

151 1/2
19,5 cm
0100-151/
radici superiori

145
19 cm
0100-145
radici inferiori

346
18,5 cm
0100-346
radici inferiori

168 Trotter
16,5 cm
0100-168
canini superiori

PINZE PER ESTRAZIONE

senza profilo ritentivo

con profilo ritentivo



167 Trotter
16 cm
0100-167
pinza universale per denti inferiori in particolare molari e premolari



169 Trotter
16 cm
0100-169
denti del giudizio superiori



359
16 cm
0100-359
radici inferiori



349
19 cm
0100-349
radici superiori

PINZE PER ESTRAZIONE - ASALADY

con profilo ritentivo



1
16 cm
W0160-1
incisivi e canini superiori



2
16 cm
W0160-2
incisivi e canini superiori



4
14,5 cm
W0160-4
incisivi e canini inferiori



7
15,5 cm
W0160-7
incisivi superiori
premolari superiori



13
14 cm
W0160-13
premolari inferiori



17
15 cm
W0160-17
molari superiori destri



18
15,5 cm
W0160-18
molari superiori sinistri

PINZE PER ESTRAZIONE - ASALADY
con profilo ritentivo

PINZE PER ESTRAZIONE - ASALADY
con profilo ritentivo

senza profilo ritentivo



21
14,5 cm
W0160-21
molari inferiori



22
14 cm
W0160-22
molari inferiori

33
13,5 cm
W0160-33
radici inferiori

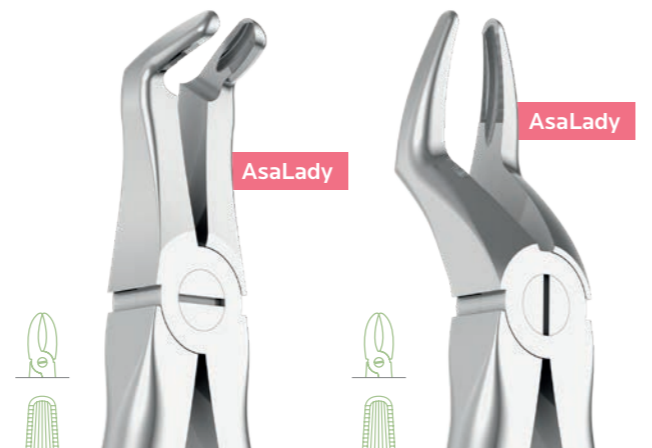

45
16 cm
W0160-45
radici inferiori

51A
17 cm
W0160-51A
radici superiori



67A
17 cm
W0160-67A
denti del giudizio superiori

74
14,5 cm
W0160-74
radici inferiori

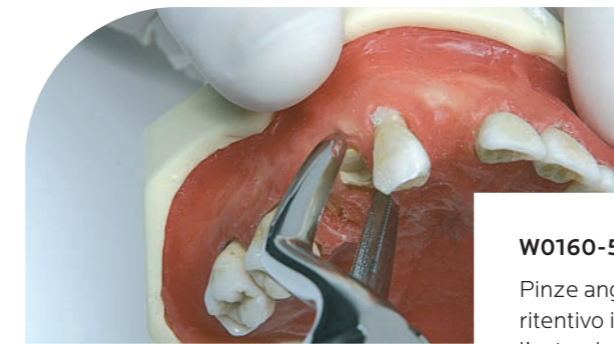

W0160-51A
Pinze angolate con profilo ritentivo indicate per l'estrazione di radici superiori.



79
15,5 cm
W0160-79
denti del giudizio inferiori



145
16 cm
W0160-145
radici inferiori



151 1/2
17,5 cm
W0160-151/
radici superiori



86C
14,5 cm
W0160-86C
molari inferiori

PINZE PER ESTRAZIONE - MEAD
con profilo ritentivo



1
17 cm
0104-1
pinza universale per
incisivi e canini superiori



2
16,5 cm
0104-2
molari superiori



3
15 cm
0104-3
incisivi, premolari
e radici inferiori



4
15 cm
0104-4
molari inferiori

PINZE PER ESTRAZIONE - FORMA AMERICANA
senza profilo ritentivo



5 Physick
17,5 cm
0120-5
denti del giudizio inferiori



6
17 cm
0120-6
pinza per separare



10S
19 cm
0120-10S
molari superiori



16
16,5 cm
0120-16
molari inferiori



17
17,5 cm
0120-17
molari inferiori

PINZE PER ESTRAZIONE - FORMA AMERICANA

senza profilo ritentivo



18L Harris
18 cm
0120-18L
molari superiori sinistri



18R Harris
18 cm
0120-18R
molari superiori destri



23
17,5 cm
0120-23
molari inferiori



53R
18,5 cm
0120-53R
molari superiori destri



53L
18,5 cm
0120-53L
molari superiori sinistri



PINZE PER ESTRAZIONE - FORMA AMERICANA

senza profilo ritentivo



65
19 cm
0120-65
incisivi e radici superiori



69 Tomes
18,5 cm
0120-69
radici superiori
e inferiori



88R Nevius
18,5 cm
0120-88R
molari superiori destri



88L Nevius
18,5 cm
0120-88L
molari superiori sinistri



101 Hull
15,5 cm
0120-101
denti di latte



PINZE PER ESTRAZIONE - FORMA AMERICANA

senza profilo ritentivo



150 Cryer
18 cm
0120-150
incisivi superiori, premolari, radici



150S Cryer
15,5 cm
0120-150S
denti superiori
(per bambini)

151 Cryer
18,5 cm
0120-151
incisivi inferiori, premolari,
radici



151S Cryer
15 cm
0120-151S
denti inferiori
(per bambini)

222
18,5 cm
0120-222
denti del giudizio inferiori

PINZE PER ESTRAZIONE - FORMA AMERICANA - ASALADY

senza profilo ritentivo



5 Physick
16,5 cm
W0121-5
denti del giudizio inferiori



6
16,5 cm
W0121-6
pinza per separare

10S
18 cm
W0121-10S
molari superiori



16
16 cm
W0121-16
molari inferiori

17
16,5 cm
W0121-17
molari inferiori

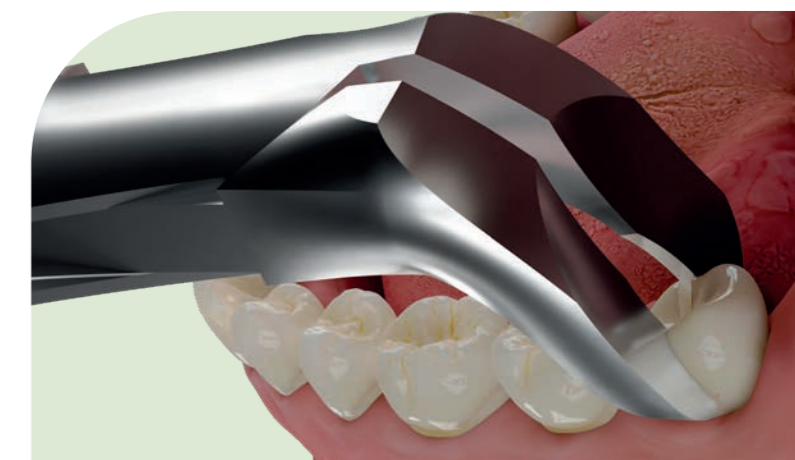

W0121-5

PINZE PER ESTRAZIONE - FORMA AMERICANA - ASALADY

senza profilo ritentivo



18L Harris
16 cm
W0121-18L
molari superiori sinistri



AsaLady



18R Harris
16 cm
W0121-18R
molari superiori destri



AsaLady



23
16 cm
W0121-23
molari inferiori



AsaLady



53R
17 cm
W0121-53R
molari superiori destri



AsaLady



53L
17 cm
W0121-53L
molari superiori sinistri



AsaLady

PINZE PER ESTRAZIONE - FORMA AMERICANA - ASALADY

senza profilo ritentivo



65
18 cm
W0121-65
incisivi e radici superiori



AsaLady



69 Tomes
17 cm
W0121-69
radici superiori e inferiori



AsaLady



88R Nevius
17,5 cm
W0121-88R
molari superiori destri



AsaLady



88L Nevius
17,5 cm
W0121-88L
molari superiori sinistri



AsaLady



101 Hull
16 cm
W0121-101
denti di latte



AsaLady

PINZE PER ESTRAZIONE - FORMA AMERICANA - ASALADY

senza profilo ritentivo



150 Cryer
16,5 cm
W0121-150
incisivi superiori, premolari, radici



150S Cryer
16 cm
W0121-150S
denti superiori
(per bambini)

151 Cryer
16,5 cm
W0121-151
incisivi inferiori, premolari,
radici



151S Cryer
16,5 cm
W0121-151S
denti inferiori
(per bambini)

222
17 cm
W0121-222
denti del giudizio inferiori

PINZE PER ESTRAZIONE - MANICO ANATOMICO

con profilo ritentivo



1
17 cm
0130-1
incisivi e canini superiori



2
17 cm
0130-2
incisivi e canini superiori

4
15,5 cm
0130-4
incisivi e canini inferiori



7
17 cm
0130-7
premolari superiori

13
14,5 cm
0130-13
premolari inferiori

PINZE PER ESTRAZIONE - MANICO ANATOMICO
con profilo ritentivo



17
16,5 cm
0130-17
molari superiori destri



18
17 cm
0130-18
molari superiori sinistri

21
16,5 cm
0130-21
molari inferiori



22
15 cm
0130-22
molari inferiori

33
15 cm
0130-33
radici inferiori



45
19 cm
0130-45
radici inferiori

51A
18,5 cm
0130-51A
radici superiori

PINZE PER ESTRAZIONE - MANICO ANATOMICO
con profilo ritentivo



67A
18,5 cm
0130-67A
denti del giudizio superiori



74
15,5 cm
0130-74
radici inferiori



79
17,5 cm
0130-79
denti del giudizio inferiori



86C
15,5 cm
0130-86C
molari inferiori

PINZE PER ESTRAZIONE - MANICO ANATOMICO

con profilo ritentivo



89
17,5 cm
0130-89
molari superiori destri



90
17,5 cm
0130-90
molari superiori sinistri

145
19 cm
0130-145
radici inferiori



151 1/2
19,5 cm
0130-151/
radici superiori

349
19 cm
0130-349
radici superiori



359
15,5 cm
0130-359
radici inferiori

PINZE PER ESTRAZIONE PER BAMBINI

con profilo ritentivo



13S
14,5 cm
0110-13S
premolari inferiori



22S
14 cm
0110-22S
molari inferiori

30S
16 cm
0110-30S
incisivi e radici superiori



33S
14 cm
0110-33S
radici inferiori

37
15 cm
0110-37
incisivi superiori, premolari, radici

PINZE PER ESTRAZIONE PER BAMBINI

con profilo ritentivo



S0110

0110-37	37
0110-39	39
0110-39R	39R
0110-39L	39L
0110-51S	51S
0110-13S	13S
0110-30S	30S
0110-33S	33S
0110-22S	22S
0110-38	38



38
14 cm
0110-38
incisivi e canini inferiori



39
16 cm
0110-39
molari superiori

39R
16 cm
0110-39R
molari superiori destri



39L
16 cm
0110-39L
molari superiori sinistri

51S
17 cm
0110-51S
radici superiori

PINZE PER ESTRAZIONE PER BAMBINI - MODELLO KLEIN

con profilo ritentivo



S0112

0112-1	1
0112-2	2
0112-3	3
0112-4	4
0112-5	5
0112-6	6
0112-7	7

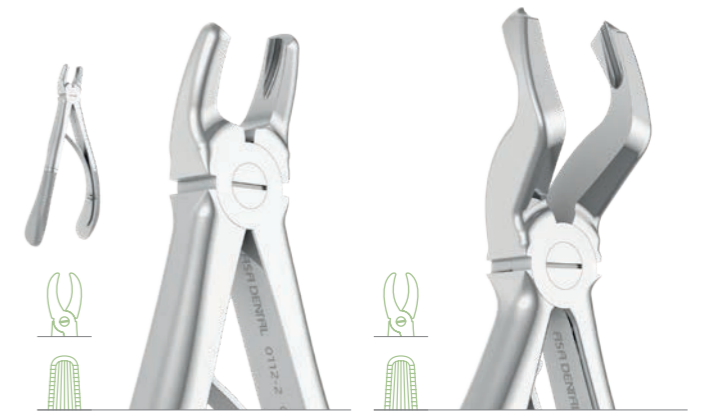

2
12,5 cm
0112-2
premolari superiori

3
13 cm
0112-3
molari superiori



4
13 cm
0112-4
radici superiori

5
13 cm
0112-5
incisivi inferiori



1
12 cm
0112-1
incisivi superiori



6
12,5 cm
0112-6
molari inferiori

7
13 cm
0112-7
radici inferiori

PINZE PER RADICI

con profilo ritentivo

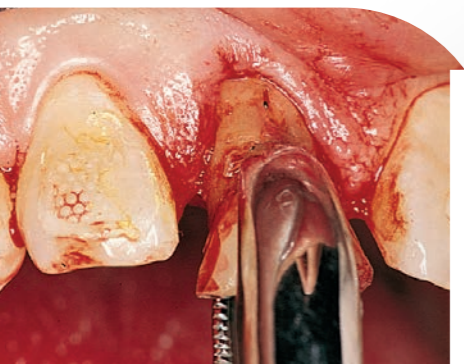

0101-1

Le pinze Witzel sono strumenti per estrazione estremamente versatili che possono essere utilizzati sia per denti che per radici.

Il profilo ritentivo, unito alla forma curva e affusolata delle punte, permette a queste pinze di lavorare in modo ottimale sulle radici senza il rischio di causare rotture.



1 Witzel
16,5 cm
0101-1
radici inferiori



2 Witzel
16 cm
0101-2
radici superiori

PINZE PER RADICI E FRAMMENTI

senza profilo ritentivo

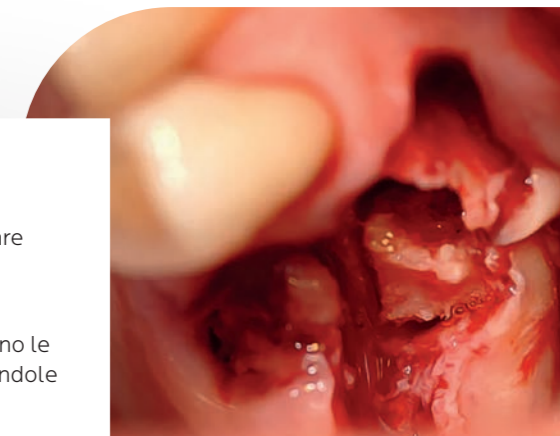

0102-1

Queste pinze sono state concepite per amplificare la sensibilità e garantire la precisione.

L'impugnatura tipica delle forbici favorisce la manovrabilità, mentre le punte sottili raggiungono le schegge delle radici anche in profondità, afferrandole saldamente.



1 Stieglitz
14,5 cm
0102-1
frammenti di radici



2 Stieglitz
14 cm
0102-2
frammenti di radici

PINZE OSSIVORE ALVEOLOTOME

PINZE OSSIVORE ALVEOLOTOME



Luer
15 cm
0103-10



Friedman
14,5 cm
0103-20



Mini Friedman
12 cm
0103-25



Cleveland 5
16,5 cm
0103-40



Cleveland-Gardner
16,5 cm
0103-45



Blumenthal
15 cm
0103-30



45°
Blumenthal
13,5 cm
0103-31



90°
Blumenthal
14 cm
0103-32



Mead 1A
16,5 cm
0103-50

PINZE OSSIVORE ALVEOLOTOME
doppio snodo



Mini-Ruskin
15,5 cm
0103-70



Beyer
18 cm
0103-71

PINZA PER TESSUTI
dimensioni ridotte per
accesso in aree molto limitate



Goldman-Fox
10 cm
0103-60

LEVE PER RADICI CON MANICO IN ACCIAIO INOX

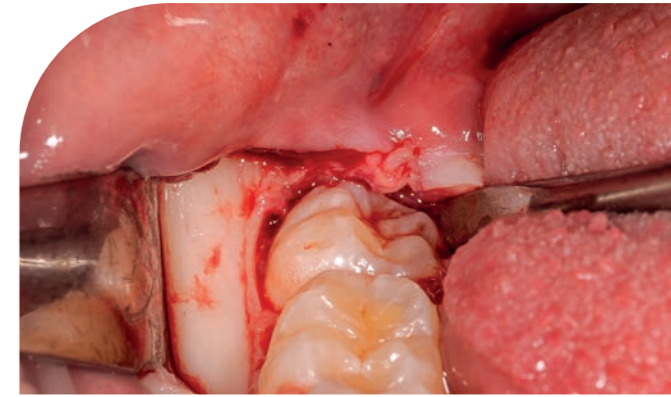

0234-1



1 Hylin
0234-1



2 Hylin
0234-2



3 Hylin
0234-3



4 Hylin
0234-4

LEVE LUSSATRICI ATRAUMATICHE - IDEAL
periotomi per lussazione atraumatica



2
0280-2R
dritto, 2 mm

3
0280-3R
dritto, 3 mm

3
0280-3C
curvo, 3 mm

5
0280-5R
dritto, 5 mm

LEVE LUSSATRICI ATRAUMATICHE - IDEAL
periotomi doppia lama per lussazione atraumatica



5
0280-5C
curvo, 5 mm

3
0280-3DF
3 mm

5
0280-5DF
5 mm

SET LEVE PER RADICI
con manico in plastica



S0280-4
include:
0280-3R
0280-3C
0280-5R
0280-5C

LEVE PER RADICI CON MANICO IN ACCIAIO INOX

LEVE PER RADICI CON MANICO IN ACCIAIO INOX

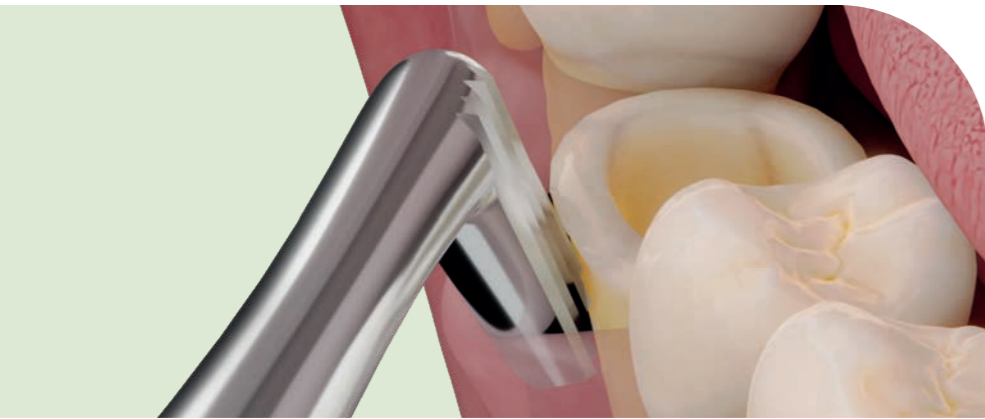

0231-2



S0200-6

0200-1	1B
0200-4	4B
0201-2	2F
0201-3	3F
0220-44	44
0220-45	45



LEVE PER RADICI CON MANICO IN ACCIAIO INOX

LEVE PER RADICI CON MANICO IN ACCIAIO INOX



S0200-10



2F Flohr
0201-2



3F Flohr
0201-3



4B SA
Schmeckebier
Apexo
0205-4B



4 SA
Schmeckebier
Apexo
0205-4



5B SA
Schmeckebier
Apexo
0205-5B



5 SA
Schmeckebier
Apexo
0205-5

0200-2	2B
0200-3	3B
0200-4	4B
0201-2	2F
0201-3	3F
0291-1	1
0291-2	2
0291-3	3
0202-320	320
0202-321	321

LEVE PER RADICI CON MANICO IN ACCIAIO INOX
con punte elicoidali



S0244-6

0244-1	1K
0244-2	2K
0244-3	3K
0244-4	4K
0244-5	5K
0244-6	6K



1K Kopp
0244-1



2K Kopp
0244-2



3K Kopp
0244-3



5K Kopp
0244-5



6K Kopp
0244-6



4K Kopp
0244-4

LEVE PER RADICI CON MANICO IN ACCIAIO INOX
con punte elicoidali



1
0218-1



2
0218-2



3
0218-3



1
0219-1



2
0219-2



4
0218-4

LEVE PER RADICI CON MANICO IN ACCIAIO INOX

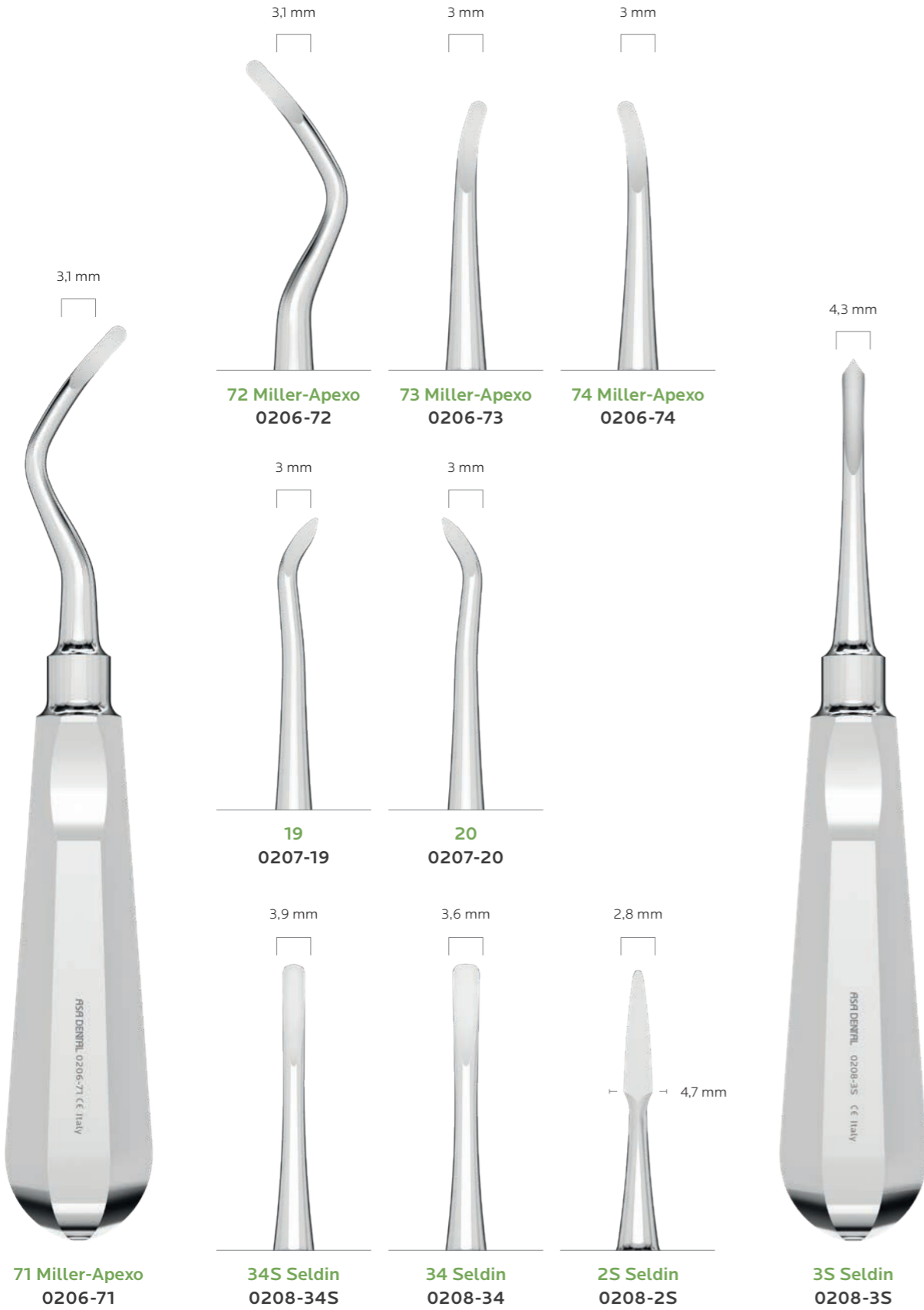

LEVE PER RADICI CON MANICO IN ACCIAIO INOX



LEVE PER RADICI CON MANICO IN ACCIAIO INOX

LEVE PER RADICI CON MANICO IN ACCIAIO INOX

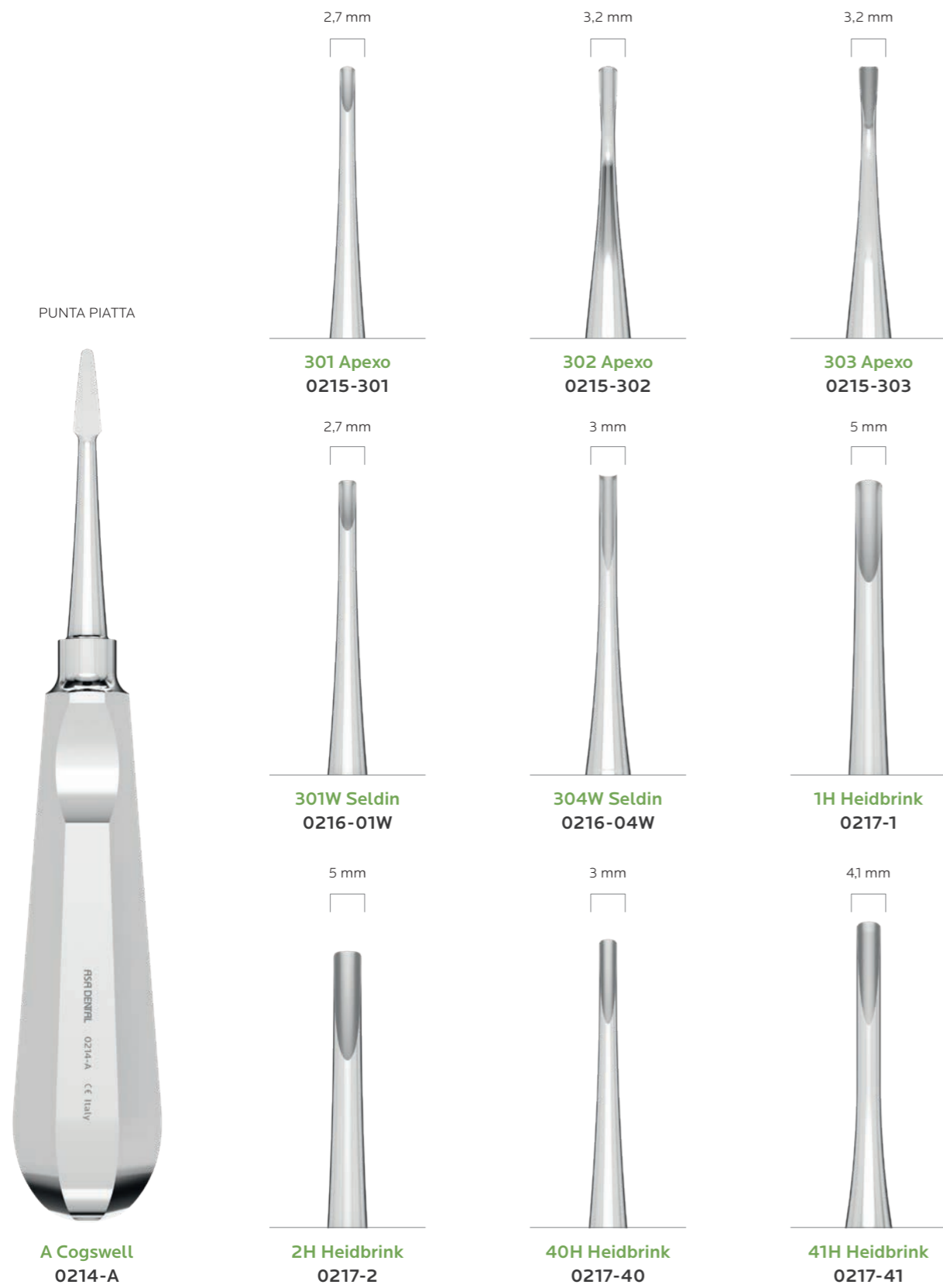

LEVE PER RADICI CON MANICO IN ACCIAIO INOX



LEVE PER RADICI CON MANICO IN ACCIAIO INOX

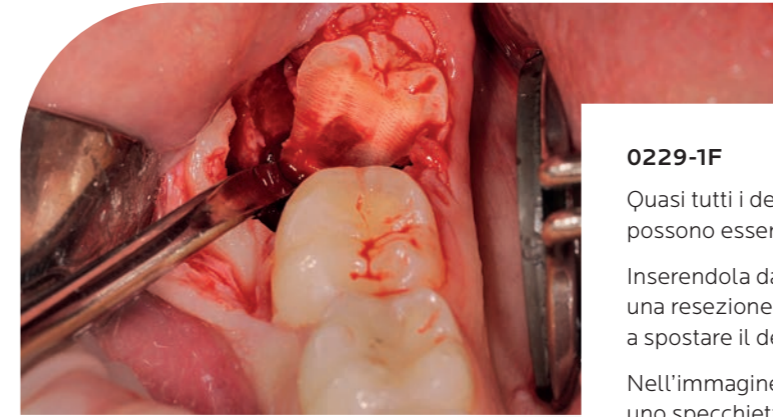

0229-1F

Quasi tutti i denti del giudizio inferiori inclusi possono essere estratti con questa leva.

Inserendola dall'alto nello spazio creato tramite una resezione dell'osso, la leva di Friedman riesce a spostare il dente verso l'alto e all'indietro.

Nell'immagine si vedono la leva di Friedman e uno specchietto in azione su un frammento di terzo molare.



LEVE PER RADICI CON MANICO IN ACCIAIO INOX

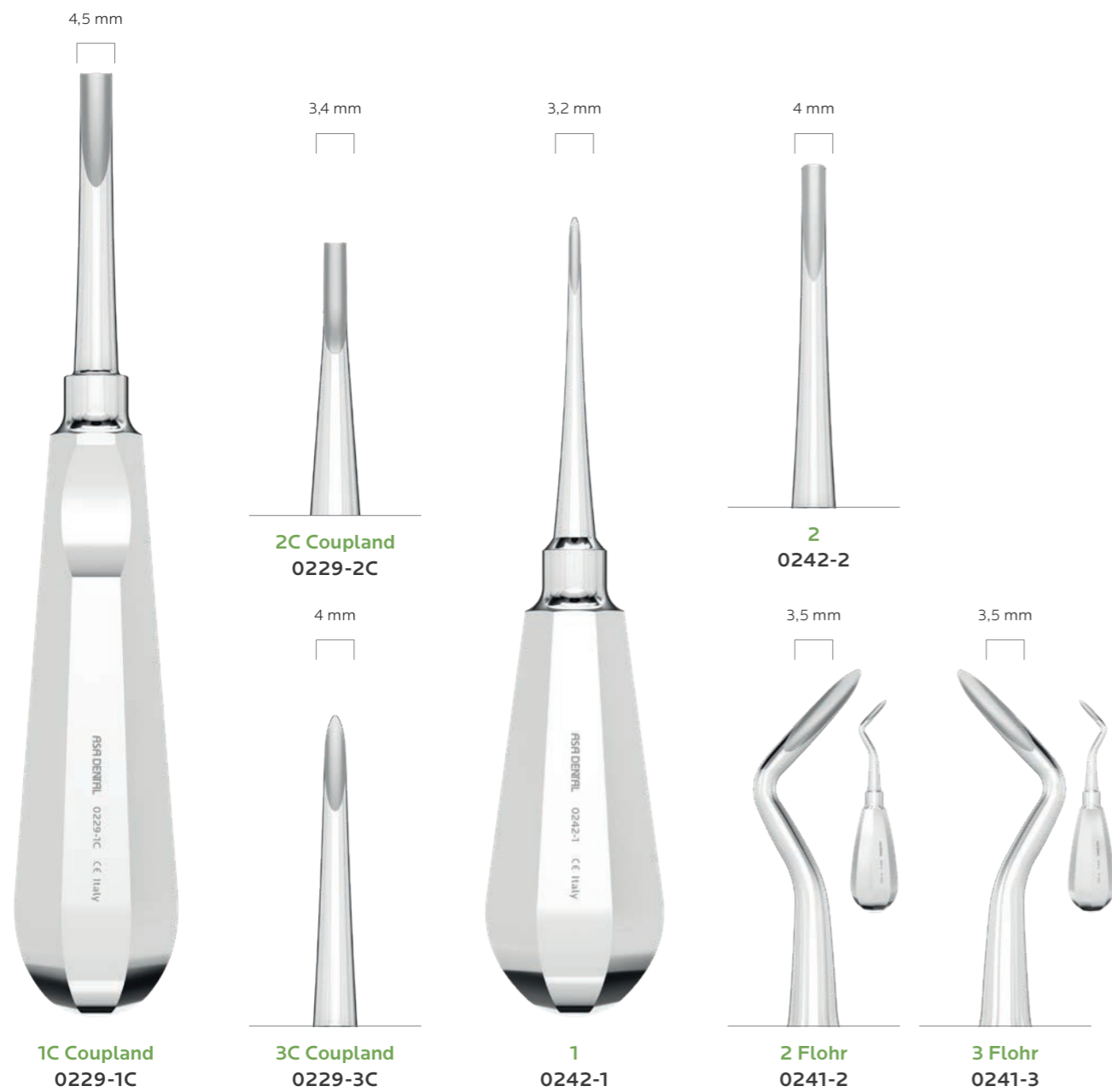

LEVE PER RADICI CON MANICO IN ACCIAIO INOX ANATOMICO



LEVE PER RADICI CON MANICO IN ACCIAIO INOX ANATOMICO



LEVE PER RADICI CON MANICO IN ACCIAIO INOX



LEVE PER RADICI CON MANICO IN ACCIAIO INOX



LEVE PER RADICI CON MANICO IN ACCIAIO INOX



MINI-LEVE PER FRAMMENTI DI RADICI CON MANICO IN ACCIAIO INOX



MINI-LEVE PER FRAMMENTI DI RADICI CON MANICO IN ACCIAIO INOX

SINDESMOTOMI CON MANICO IN ACCIAIO INOX



1 Heidbrink
0290-1



2 Heidbrink
0290-2



3 Heidbrink
0290-3

2,8 mm



1 Warwick-James
0294-1

2 mm



2 Warwick-James
0294-2

2 mm



3 Warwick-James
0294-3



1 Chompret
0295-1



2 Chompret
0295-2



4 Chompret
0295-4



3 Chompret
0295-3



3 Chompret
W0298-3

AsaLady

SINDESMOTOMI

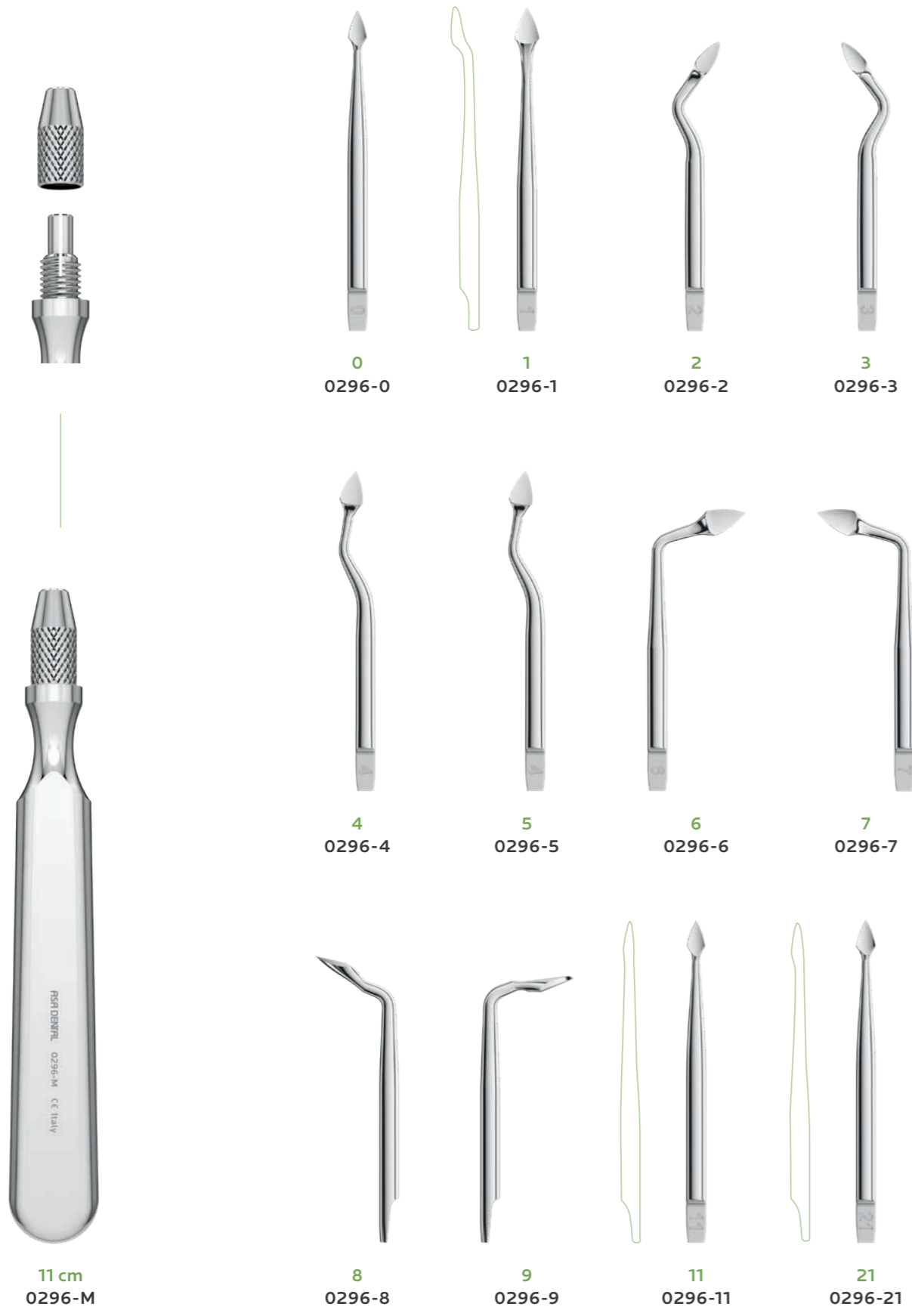

SINDESMOTOMI

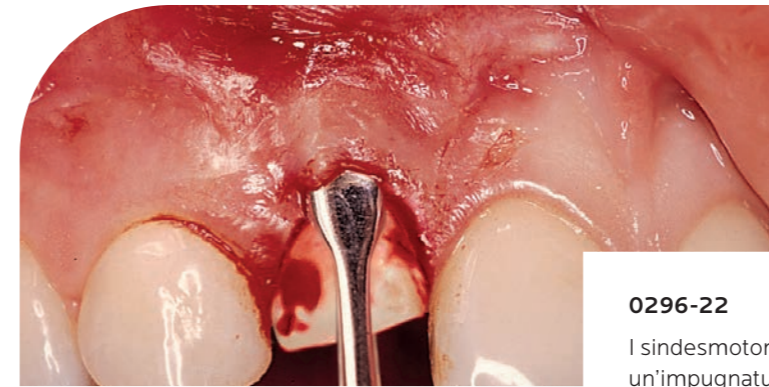

0296-22

I syndesmotomi Asa Dental offrono il vantaggio di un'impugnatura ergonomica alla quale applicare, di volta in volta, la punta più adatta per risolvere il caso in esame.

Tipicamente utilizzati in modo efficace per preparare il campo ad un'estrazione atraumatica, molti di loro possono essere comodamente utilizzati come periotomi.



DISSETTORE



PR1857-1
Perfection

PERIOTOMI



1 ML1845-1 **2** ML1845-2 **3** ML1845-3



PR1857-1

Utilizzato subito dopo l'incisione del bisturi, questo strumento facilita l'incisione del periostio fino all'esposizione del tessuto osseo.

KIT DI SINDESMOTOMI

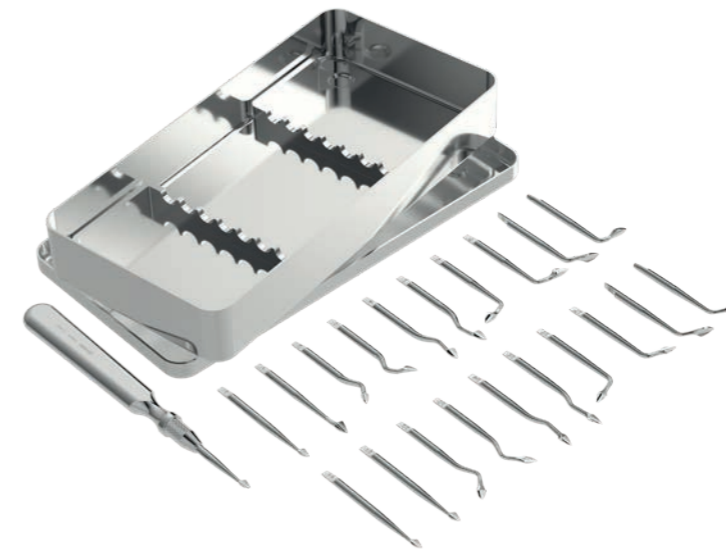

S0296

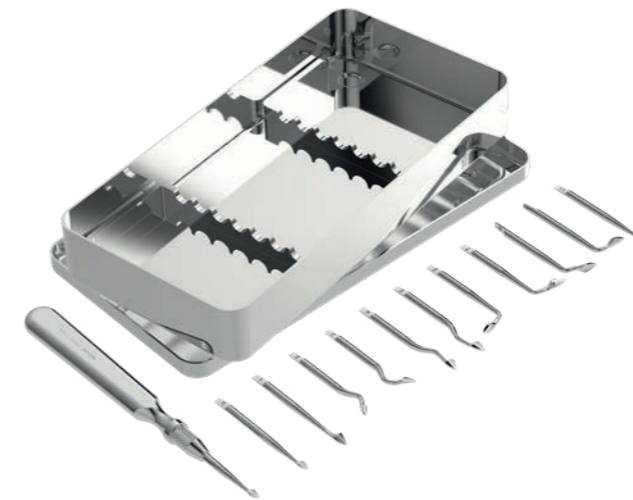

S0296-1



0297-1
Portapunte per sindesmotomi
20 fori
70x40x12 mm

0296-M	manico per sindesmotomi	
0296-0	punta sindesmotomo	0
0296-1	punta sindesmotomo	1
0296-2	punta sindesmotomo	2
0296-3	punta sindesmotomo	3
0296-4	punta sindesmotomo	4
0296-5	punta sindesmotomo	5
0296-6	punta sindesmotomo	6
0296-7	punta sindesmotomo	7
0296-8	punta sindesmotomo	8
0296-9	punta sindesmotomo	9
0296-11	punta sindesmotomo	11
0296-21	punta sindesmotomo	21
0296-22	punta sindesmotomo	22
0296-23	punta sindesmotomo	23
0296-24	punta sindesmotomo	24
0296-25	punta sindesmotomo	25
0296-26	punta sindesmotomo	26
0296-27	punta sindesmotomo	27
0296-28	punta sindesmotomo	28
0296-29	punta sindesmotomo	29
S2700	vassoio completo di griglia	

0296-M	manico per sindesmotomi	
0296-0	punta sindesmotomo	0
0296-1	punta sindesmotomo	1
0296-2	punta sindesmotomo	2
0296-3	punta sindesmotomo	3
0296-4	punta sindesmotomo	4
0296-5	punta sindesmotomo	5
0296-6	punta sindesmotomo	6
0296-7	punta sindesmotomo	7
0296-8	punta sindesmotomo	8
0296-9	punta sindesmotomo	9
0296-11	punta sindesmotomo	11
S2700	vassoio completo di griglia	



KIT PER CHIRURGIA ORALE ED ESTRATTIVA



Kit chirurgia orale
SPR2781-S

ML2101	manico per specchietti	
2230-5	specchietto doppio	5
0702L-15	sonda millimetrica parodontale	CP-15
0350-5	manico per bisturi e lama	5
PR1857-1	dissetto	
MV1851-PR3	scollaperiostio Prichard	PR3
PR0625-2	pinzetta chirurgica	
1855-23	divaricatore Seldin	23
2616-1	divaricatore Farabeuf	
0229-2F	leve per radici Friedman	
0229-1F	leve per radici Friedman	
0291-1F	leve per radici Mini Friedman	
0291-2F	leve per radici Mini Friedman	
ML2001-85	cucchiaio alveolare Lucas	85
ML2001-87	cucchiaio alveolare Lucas	87
ML2001-88	cucchiaio alveolare Lucas	88
ML1806-2RL	strumento parodontale	2R/2L
ML1806-4RL	strumento parodontale	4R/4L
PR0460-15TC	porta aghi Castroviejo	
0309-2TC	forbicine per gengive	2TC
2780-1B	cassetta portastrumenti	



S0100-3

0100-33	pinza per estrazione	33
0100-51A	pinza per estrazione	51A
0100-67A	pinza per estrazione	67A
0100-79	pinza per estrazione	79
0200-1	leva per radici	1B
0201-2	leva per radici	2F
0201-3	leva per radici	3F
0202-320	leva per radici	320
0202-321	leva per radici	321



S0100-4

0100-33	pinza per estrazione	33
0100-51A	pinza per estrazione	51A
0100-67A	pinza per estrazione	67A
0100-79	pinza per estrazione	79
0200-1	leva per radici	1B
0201-2	leva per radici	2B
0201-3	leva per radici	3B
0435-14TC	porta aghi	
0425-16TC	porta aghi	

ACCESSORI

valigia portastrumenti e pinze



9002

1	9002	valigia
2	9002-2	inserto con elastici per 10 strumenti
3	9002-3	inserto con spazi per 16 strumenti
4	9002-1	inserto per 6 pinze estrattive

LUBRIFICANTI PER LA PROTEZIONE DEGLI STRUMENTI IN AUTOCLAVE

Massima protezione degli strumenti in autoclave. Penetra negli snodi e lubrifica. Protegge e lubrifica gli strumenti chirurgici e dentali prima e dopo la sterilizzazione. Modalità d'uso: oliare prima e dopo la sterilizzazione le punte, gli snodi e le chiusure degli strumenti.

Lubrificante speciale per strumenti dentali e chirurgici. Per lubrificare gli snodi di forbici, pinze per estrazione, ossivore, emostatiche, porta aghi, ecc. prima e dopo la sterilizzazione. Non prosciuga durante la sterilizzazione. Protegge dalla corrosione e da altri depositi e cura il buon funzionamento degli strumenti.



Steril Oil
40 ml
8002



Silicone
40 ml
8010

CHIRURGIA IMPLANTARE

MADE IN ITALY



IL RECUPERO DELL' ELEMENTO DENTARIO ATTRAVERSO L'USO DELLA CHIRURGIA

L'ultimo decennio è stato caratterizzato dall'ascesa della chirurgia implantare come pratica clinica utilizzata dai dentisti per migliorare la qualità di vita dei loro pazienti. Sebbene l'implantologia possa rivelarsi utile come tecnica alternativa ad altre opzioni di trattamento più convenzionali, ci sono casi in cui rappresenta la scelta obbligata per la risoluzione di problemi funzionali, anatomici o estetici che insorgono in seguito alla perdita di uno o più denti.

Asa Dental ha concepito una serie di strumenti estremamente funzionali e facili da utilizzare che

aiutano i dentisti qualificati a risolvere efficacemente anche i casi più complessi, per assicurare ai pazienti tutti i vantaggi che offre la terapia implantare, tra i quali l'elevata stabilità, la conservazione della cresta alveolare e la durata nel tempo. Le nostre competenze progettuali e produttive ci hanno permesso di instaurare proficue collaborazioni con i migliori esperti del settore, per formulare una proposta didattica di alto livello, volta all'accrescimento professionale dello specialista.

E4	Forbicine
E5	Porta aghi
E7	Bisturi
E10	Divaricatori
E13	Strumenti per il seno mascellare
E16	Martelli chirurgici
E16	Scalpelli chirurgici
E18	Osteotomi
E21	Strumenti per osso e accessori
E32	Sonde millimetriche
E32	Depth gauge
E33	Cannule per aspirazione
E33	Calibri
E34	Frese
E35	Compattatori per osso
E35	Pinzette per marcare le tasche
E36	Pinzette chirurgiche
E37	Pinzette
E38	Kit



MANICI

PUNTA SINGOLA

- Asa60**
(acciaio inox)
ø 6,0 mm
- Leonardo ML**
(acciaio inox)
ø 7,0 mm
- Perfection**
(acciaio inox)
ø 8,0 mm
- **AsaWave RC**
(resina plastica in PPSU
e anima in acciaio)
ø 7,5 / 14,5 mm



PUNTA DOPPIA

- Asa60**
(acciaio inox)
ø 6,0 mm
- Asa Light MV**
(acciaio inox, vuoto)
ø 8,0 mm
- Leonardo ML**
(acciaio inox)
ø 7,0 mm
- Perfection**
(acciaio inox)
ø 8,0 mm
- Ottagonale**
(acciaio inox)
ø 5,5 mm
- **AsaWave RC**
(resina plastica in PPSU
e anima in acciaio)
ø 7,5 / 14,5 mm

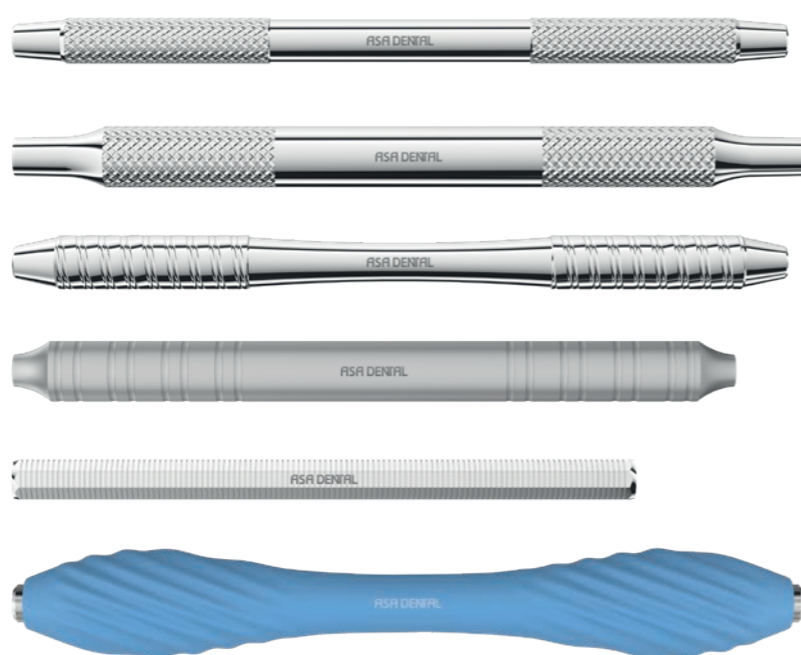

strumento standard



strumento con inserti al carburo di tungsteno (TC)

COME USARE LE INFORMAZIONI

- CP-12 — modello + nome scientifico
- RC0702-12 — codice Asa Dental
- AsaWave RC — manico

AsaLady

prodotti ergonomici progettati su misura per le mani femminili:

- manici ridotti e più leggeri
- anelli delle dita più piccoli
- dimensioni ridotte

codici con prefissi "W" o "SW"

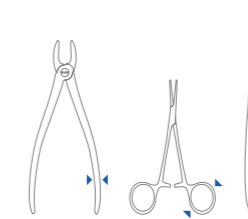

questi prodotti non sono realizzati da Asa Dental e vengono commercializzati con il marchio del produttore



vista dall'alto



vista laterale

FORBICINE PER GENGIVE



1 Goldman-Fox
retta
una lama dentata
13 cm
0304-1



2 Goldman-Fox
curva
una lama dentata
13 cm
0304-2



1TC Kelly
retta
16 cm
0309-1TC



2TC Kelly
curva
16 cm
0309-2TC

Forbicine per separare



1 Metzenbaum-Delikat
retta
14,5 cm
0322-1



2 Metzenbaum-Delikat
curva
14,5 cm
0322-2

PORTA AGHI



TC Mathieu
14 cm
0435-14TC

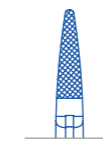

TC Mathieu
17 cm
0435-17TC

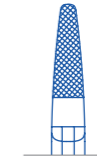

TC Lichtenberg
17 cm
0437-17TC

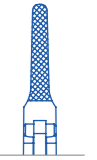

TC Castroviejo
14 cm
0445TH-14TC

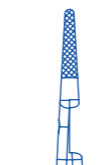

TC Castroviejo
14 cm
0446TH-14TC

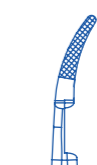

TC Castroviejo
14 cm / 60°
0448TH-14TC

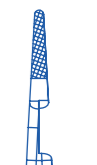

PORTA AGHI

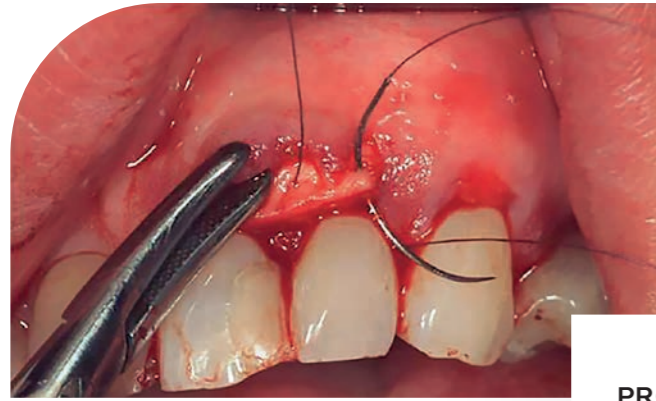

PR0460-15TC

Porta aghi Castroviejo con punte curve.
Facilita al massimo le operazioni di sutura.

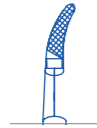

TC Castroviejo
con punte curve
15,5 cm
PR0460-15TC

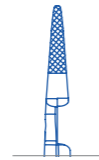

TC Micro-Barraquer
18 cm
0450TH-18TC

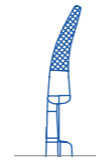

TC Micro-Barraquer
con punte curve
18 cm
0451TH-18TC

MANICI PER BISTURI



3
13 cm
0350-3



3
12 cm
W0349-3



3G
13 cm
0350-3G



8
13 cm
0350-8



7
16 cm
0350-7

MANICI PER BISTURI

LAME PER BISTURI 
100 pz (sterili) / confezione

MICRO LAME 
25 pz (sterili) / confezione

MANICI PER BISTURI A LAMA ORIENTABILE

PINZA TOGLI LAMA



5
14,5 cm
0350-5



5A
14,5 cm
0350-5A



10
0351-10



11
0351-11



12
0351-12



12D
a doppio taglio
0351-12D



15
0351-15



15C
0351-15C



4
0366-4



7
0366-7

13,5 cm
0365-1



16 cm
0335-1
(coppia di strumenti)



16,5 cm
0352



S0352
serie composta da
0352
pinza togli lama +
0335-1
(coppia di strumenti)
manici per bisturi a
lama orientabile

BISTURI MONOUSO 
10 pz / confezione

DIVARICATORI
Divaricatore labiale

Divaricatore apribile

DIVARICATORI

Divaricatori per labbra



0371-11



0371-10



0371-12



0371-15



24 cm
2628-1



19 cm
2628-2

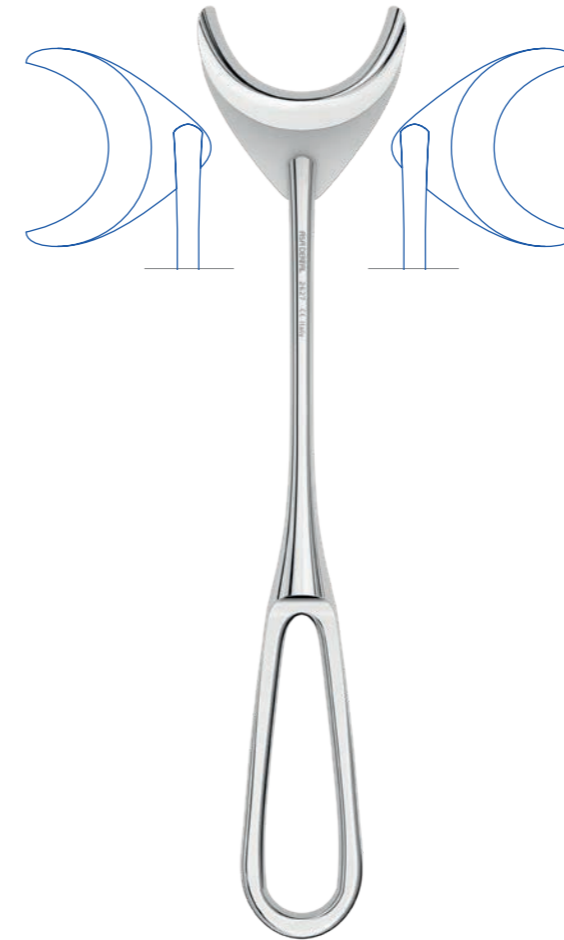

20 cm
2627

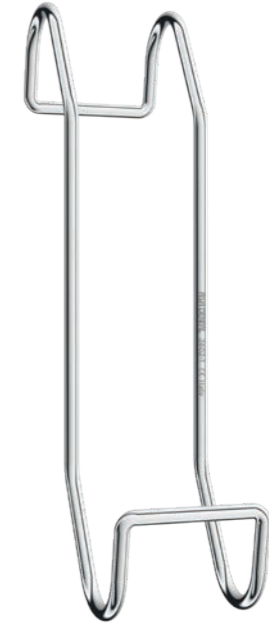

Sternberg
14 cm
2602-1



Orringer medium
11 x 8 cm
2609-2

DIVARICATORI

Divaricatori per guance



University of Minnesota
14 cm
2604



Middeldorpf
21,5 cm
2620-1

Divaricatori per spina nasale



21 cm
2625-1



21 cm
2626-1

STRUMENTI PER RIALZO DEL SENO MASCELLARE



1
MV1856-1
Asa Light MV

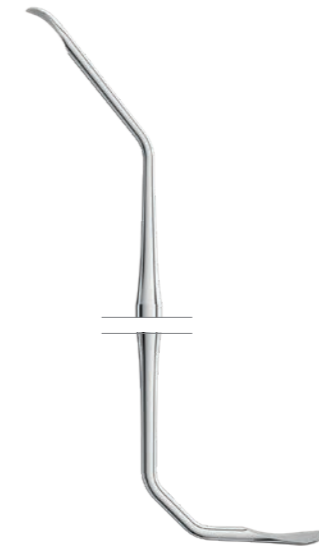

2
MV1856-2
Asa Light MV



3
MV1856-3
Asa Light MV



4
MV1856-4
Asa Light MV

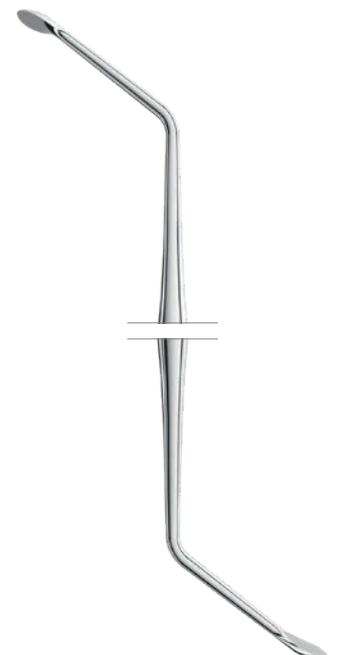

5
MV1856-5
Asa Light MV

STRUMENTI PER RIALZO DEL SENO MASCELLARE

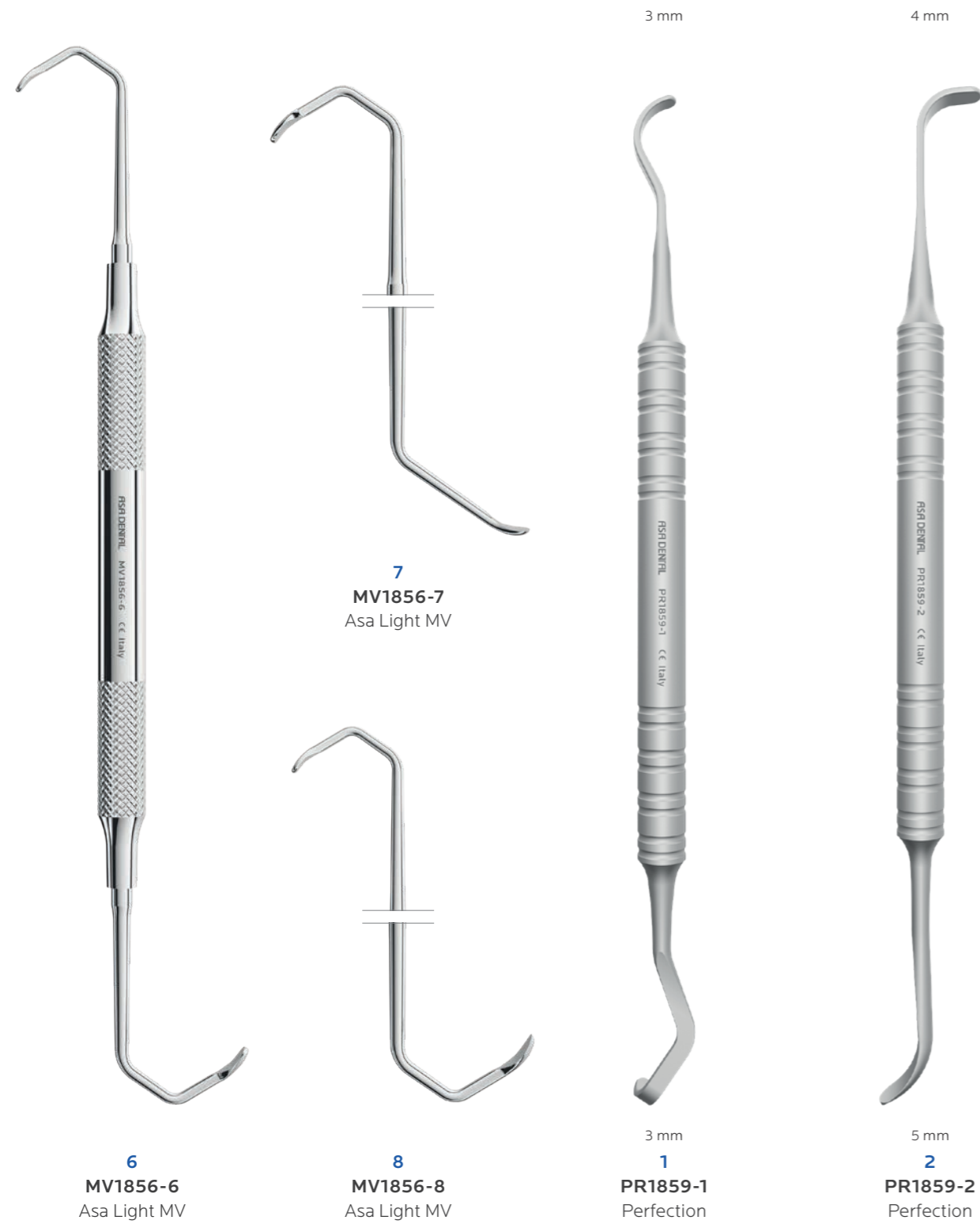

STRUMENTI PER RIALZO DEL SENO MASCELLARE

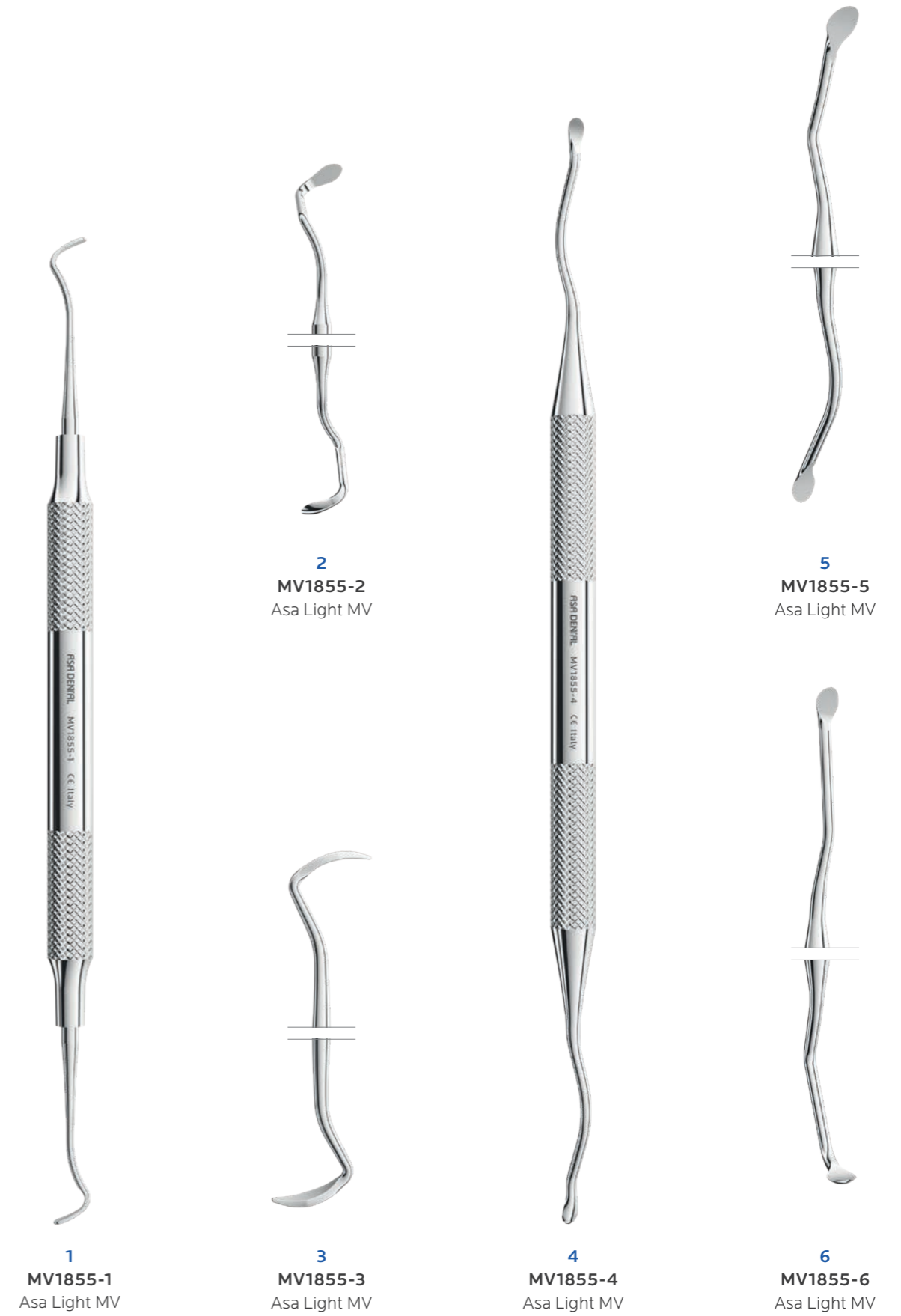

MARTELLI CHIRURGICI

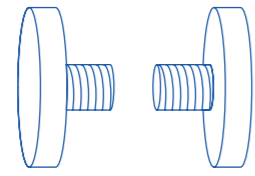

1881-R
coppia inserti di ricambio in Teflon autoclavabili max 120°



Partsch
18 cm
1880
con piombo

Mead
19,5 cm
1881

SCALPELLI FREER TAGLIO SINGOLO



1 Freer
1839-1

3 Freer
1839-3

SCALPELLI GRADUATI

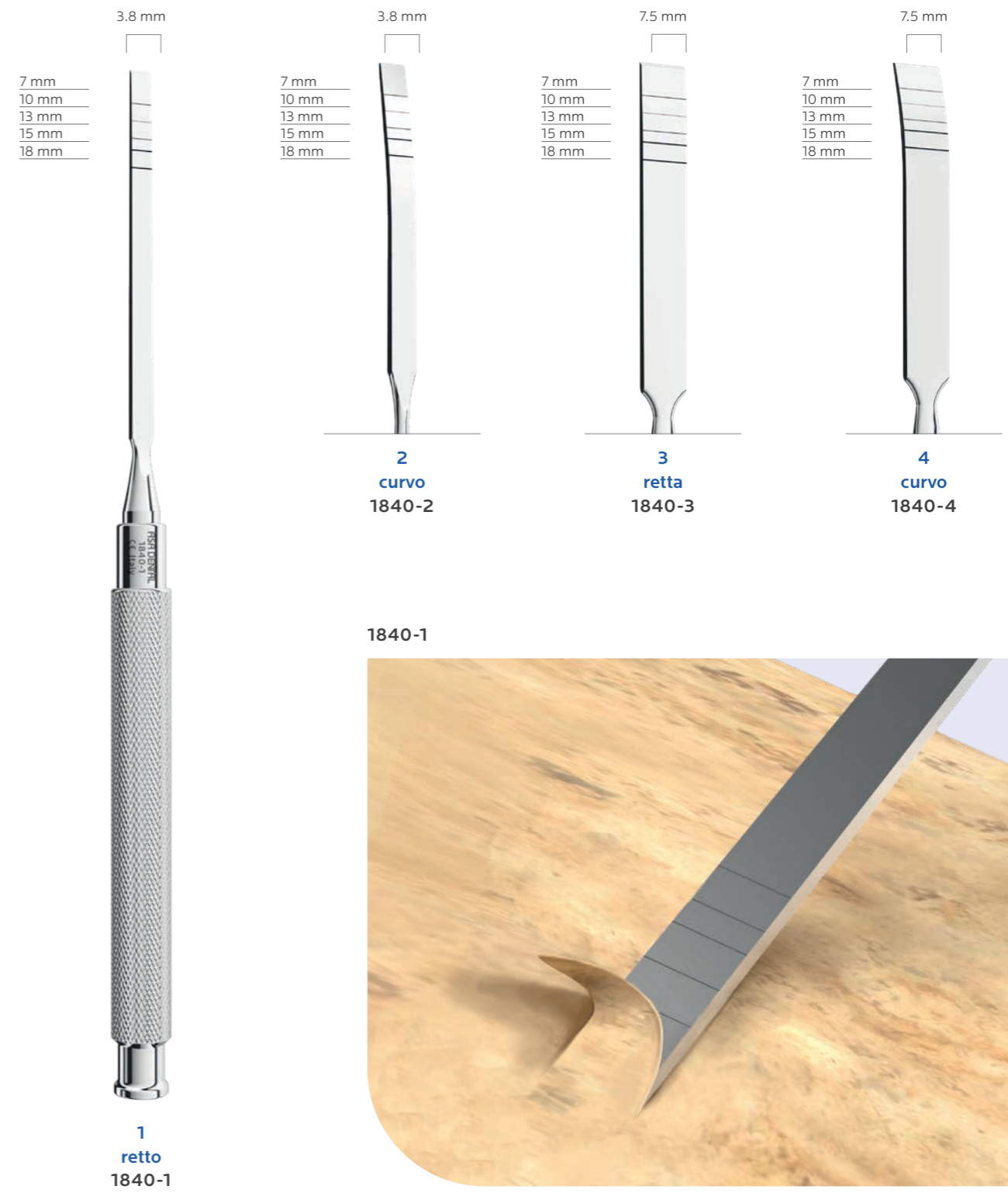

1 retto
1840-1

1840-1

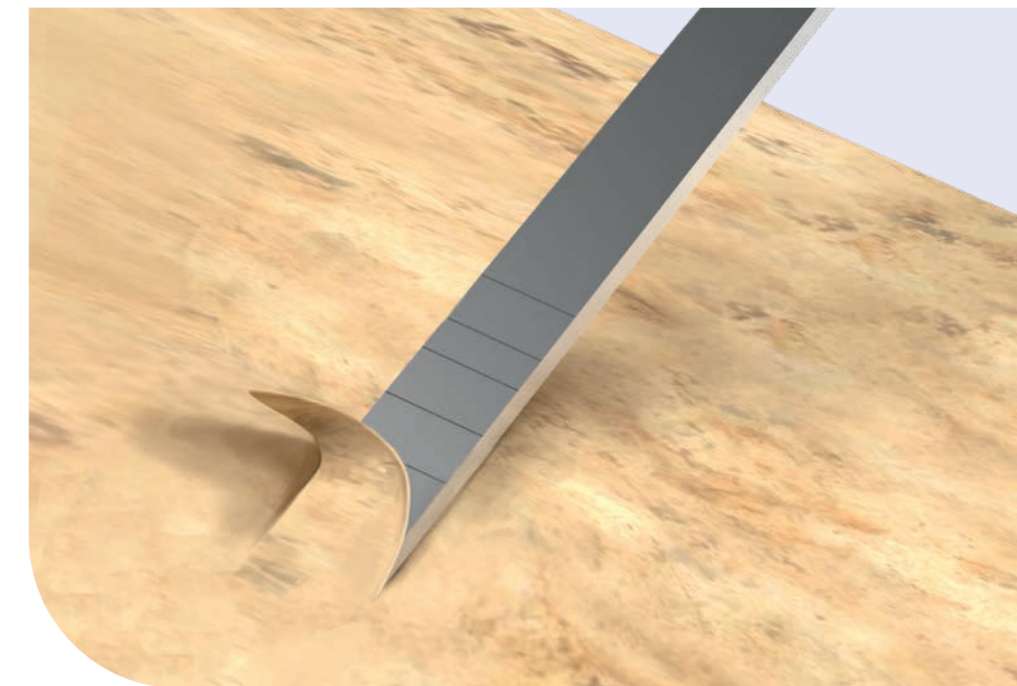

















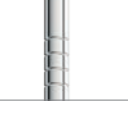

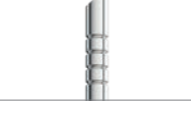
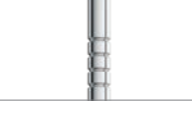



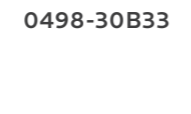
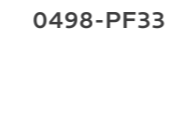

2 curvo
1840-2

3 retta
1840-3

4 curvo
1840-4

OSTEOTOMI

osteotomi anulari con stop







					
CONCAVO Ø 3 mm	CONCAVO Ø 3,3 mm	CONCAVO Ø 3 mm	CONCAVO Ø 3,3 mm	ANGOLARE Ø 3 mm	PIATTO Ø 3 mm
					
6 mm 8 mm 10 mm 12 mm 15 mm	165 mm 0498-1B33	6 mm 8 mm 10 mm 12 mm 15 mm	165 mm 0498-2C33	165 mm 0498-30B3	120 mm 0498-PF3
					
	Ø 4 mm 165 mm 0498-1B4	Ø 4 mm 165 mm 0498-2C4	Ø 3,3 mm 165 mm 0498-30B33	Ø 3,3 mm 120 mm 0498-PF33	
					
165 mm 0498-1B3	165 mm 0498-1B5	165 mm 0498-2C3	165 mm 0498-2C5	165 mm 0498-30B4	120 mm 0498-PF4
					
165 mm 0498-30B5	120 mm 0498-PF5	165 mm 0498-30B5	120 mm 0498-PF5	165 mm 0498-30B5	120 mm 0498-PF5

OSTEOTOMI



1 · 2 · 3 · 4 · 5 · 6
S0495-6
set da 6 con
vassoio
S2702

CONCAVO Ø 1,5 mm		CONCAVO Ø 1,8 mm		CONCAVO Ø 2,9 mm		CONCAVO Ø 3,1 mm		CONCAVO Ø 4,1 mm		CONCAVO Ø 5,5 mm	
mm	Ø in mm	mm	Ø in mm	mm	Ø in mm	mm	Ø in mm	mm	Ø in mm	mm	Ø in mm
7,5	1,6	7,5	2	7,5	3,1	7,5	3,8	8,5	5	8,5	6,2
9	1,7	9	2,1	9	3,2	9	3,9	10	5	10	6,2
10,5	2,2	10,5	2,9	10,5	3,3	10,5	4,1	11	5	11	6,2
12	2,4	12	3	12	3,4	12	4,2				
13,2	2,5	13,2	3,1	13,2	3,4	13,2	4,3				
15,2	3,4	15,2	3,2	15,2	3,5	15,2	4,6				

					
155 mm 0495-1	155 mm 0495-2	155 mm 0495-3	155 mm 0495-4	155 mm 0495-5	155 mm 0495-6

OSTEOTOMI

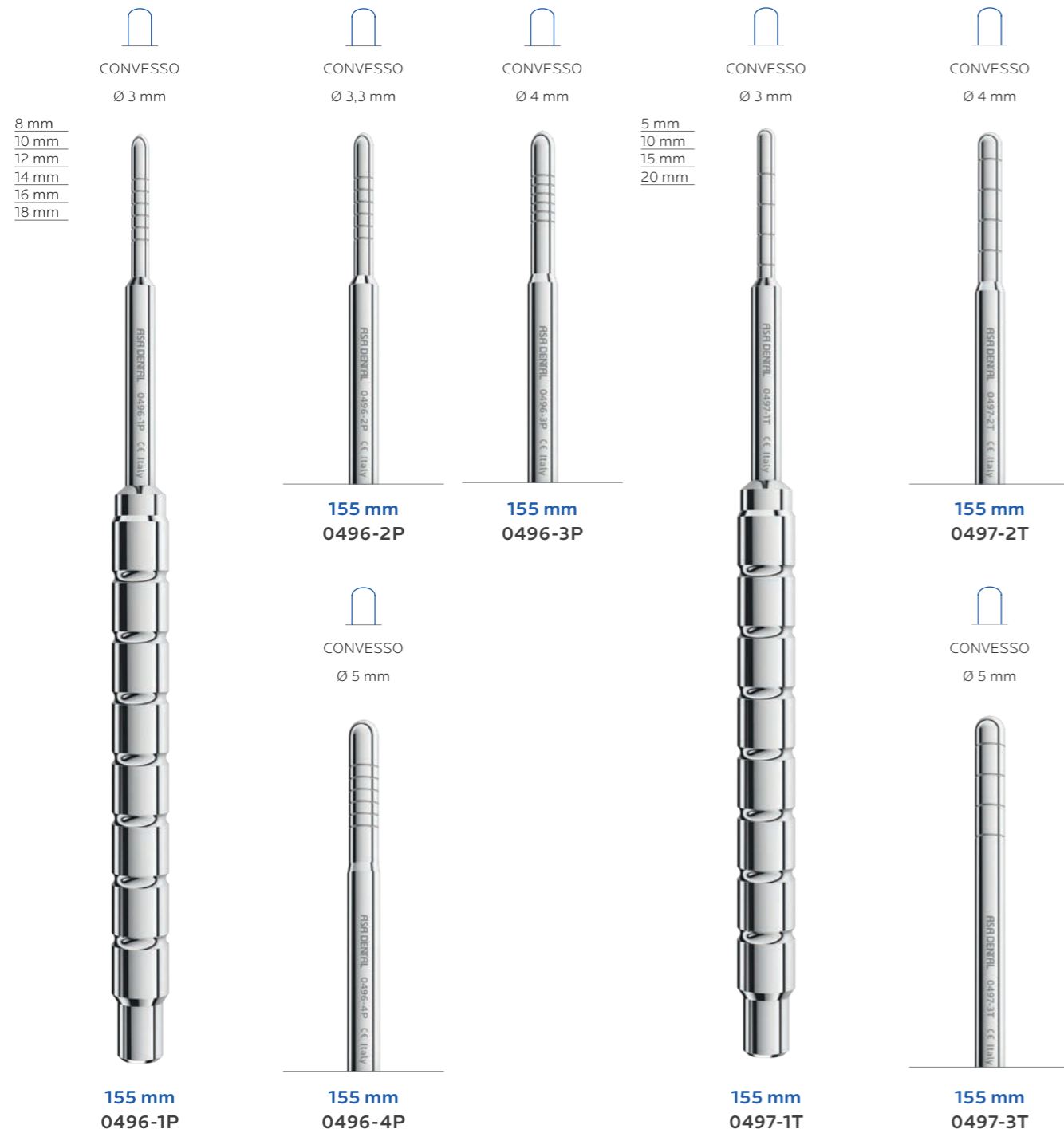

LIME PER ALVEOLOTOMIA

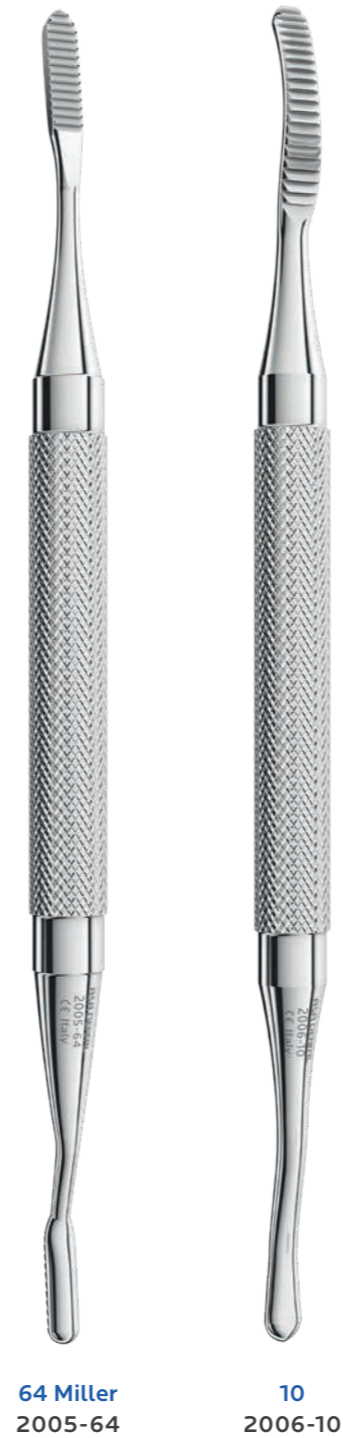

CUCCHIAI ALVEOLARI

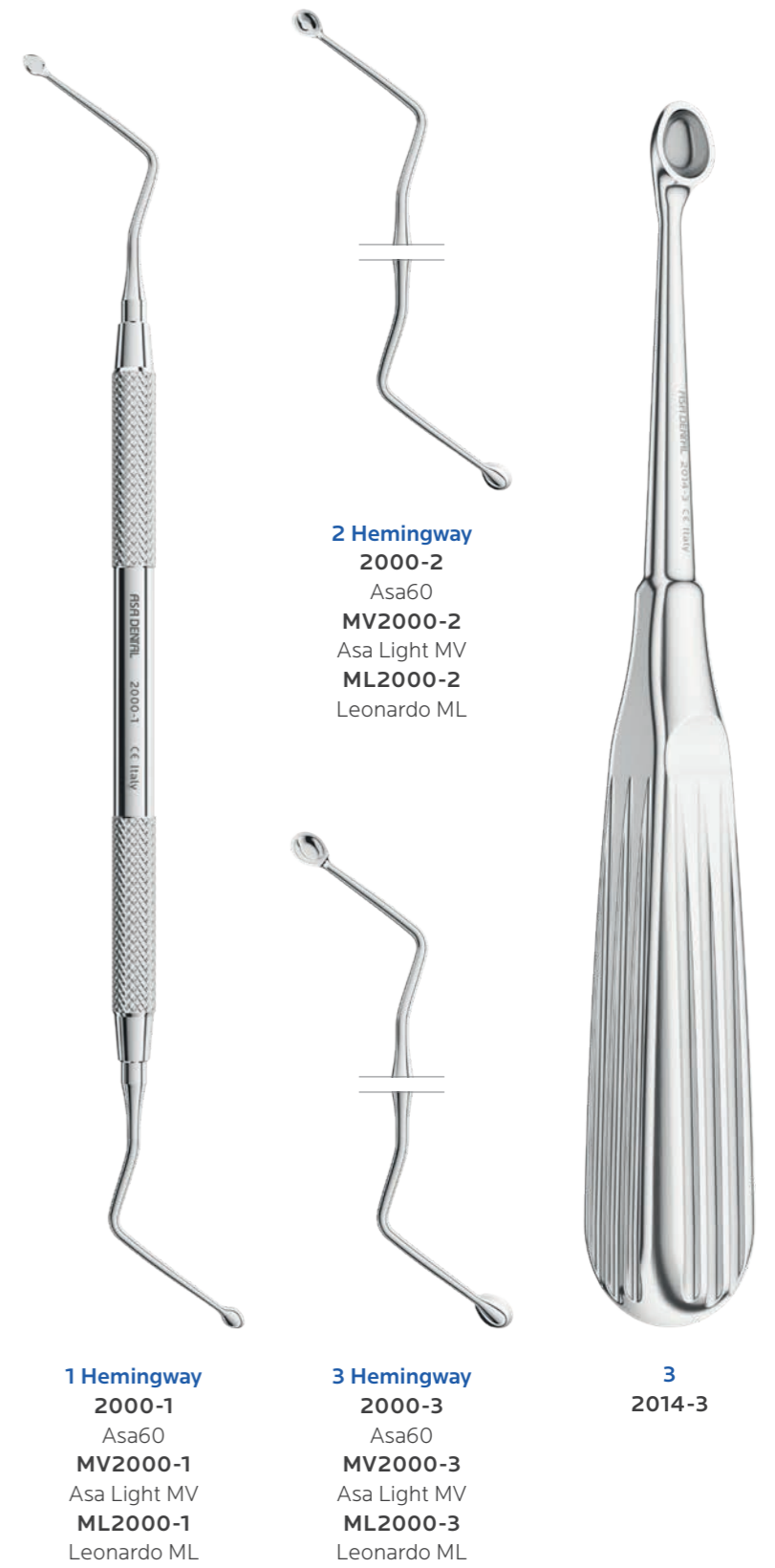

DISSETTORE



1
PR1857-1
Perfection

SCOLLAPERIOSTIO

3 mm
PUNTA LANCEOLATA



3 mm
PUNTA ARROTONDATA
Buser
PR1850-M
Perfection



Beale
5114-1
Ottagonale



GF Goldman-Fox
MV1850-GF
Asa Light MV

PR1850-M

Scollaperiostio con punta arrotondata e punta lanceolata

Consente un efficace scollamento anche nei margini gengivali più ristretti e festonati.



SCOLLAPERIOSTIO



9A Allen
MV1850-9A
Asa Light MV



M7 Molt
MV1850-M7
Asa Light MV



M8 Molt
MV1850-M8
Asa Light MV



M9 Molt
MV1850-M9
Asa Light MV



2 Hourigan
MV1851-2
Asa Light MV



PR3 Prichard
MV1851-PR3
Asa Light MV

SCOLLAPERIOSTIO

PR1850-1
SCOLLAPAPILLA

Consente lo scollamento e il sollevamento atraumatico della papilla gengivale nelle tecniche di conservazione della papilla.

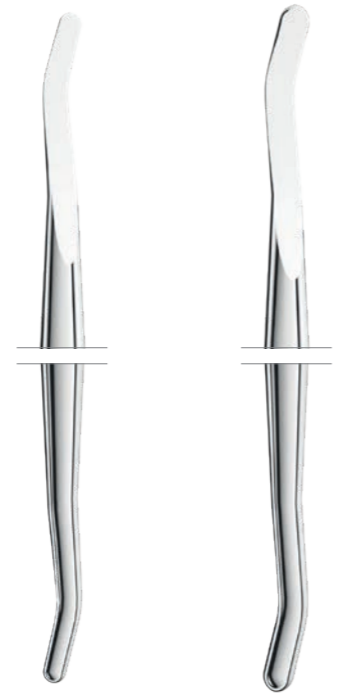

1 Hopkins
MV1852-1
Asa Light MV

2 Hopkins
MV1852-2
Asa Light MV

2 mm



2,5 mm
17 cm
PR1850-1
Perfection



Partsch
14,5 cm
1849-1
Asa60



3 Mead
MV1854-3
Asa Light MV



15 Freer
MV1853-15
Asa Light MV



16 Freer
MV1853-16
Asa Light MV

SCOLLAPERIOSTIO



22 Seldin
divaricatore
1855-22



23 Seldin
divaricatore
1855-23



König
15,5 cm
1858-1



Williger
17 cm
1856-1



Williger
16 cm
1856-2



Williger
16 cm
1857-1



Williger
13 cm
1857-2

MUCOTOMI

3 mm



retto
1844-3

4 mm



retto
1844-4

5 mm



retto
1844-5

6 mm



retto
1844-6

3 mm



curvo
1844-3C

4 mm



curvo
1844-4C

5 mm



curvo
1844-5C

6 mm



curvo
1844-6C

INIETTORI PER OSSO

Ø 2,5 mm



16 cm
0490-1

Ø 4,5 mm



16 cm
0490-2

MACINATORE PER OSSO



17 cm
1846

RASCHIETTI PER OSSO



retto
15 cm
0494-1
lama inclusa



retto
0494-1R
lama per
0494-1



curvo
15 cm
0494-2
lama inclusa



retto
0494-2R
lama per
0494-2

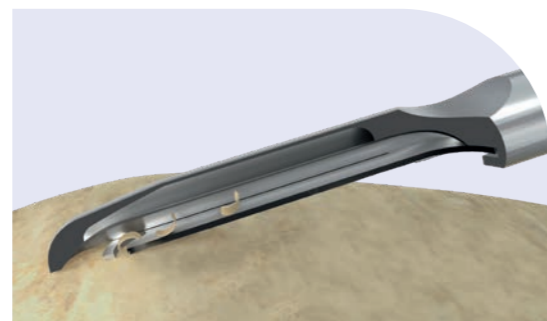

0494-1

PERIOTOMI



1
ML1845-1
Leonardo ML



2
ML1845-2
Leonardo ML



3
ML1845-3
Leonardo ML

APPLICATORE PER OSSO



MV1231-1
Asa Light MV

PINZA PER TESSUTI



Goldman-Fox
10 cm
0103-60

dimensioni ridotte per
accesso in aree molto limitate

PINZE OSSIVORE ALVEOLOTOME



Luer
14,5 cm
0103-10



Mini Friedman
12 cm
0103-25



Blumenthal
15 cm
0103-30



Blumenthal
14 cm
0103-31

SPESSIMETRI PER OSSO



0491-2



17,5 cm
0491-1



15,5 cm
0491-2

POSIZIONATORE DI MEMBRANE



Buser
MV1883
Asa Light MV

MORTAIO PER OSO



SONDE MILLIMETRICHE



MISURATORE DI PROFONDITÀ



CANNULE PER ASPIRAZIONE
Filtri per osso



CALIBRO

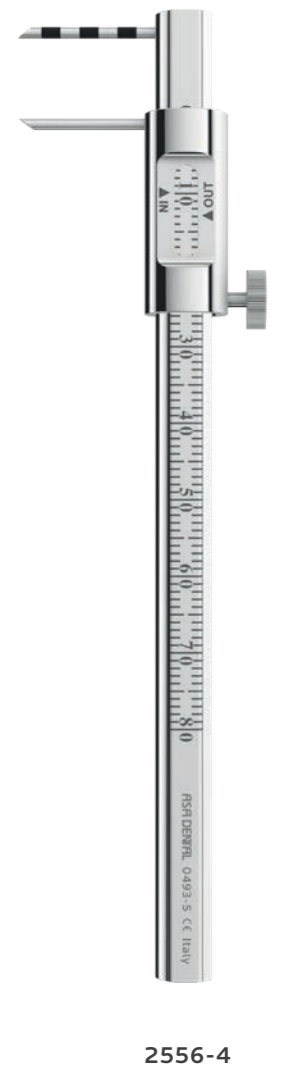

PORTA FRESE

Alluminio, sterilizzabile in autoclave a vapore saturo

con bordo, 24 fori CA
(frese grandi)

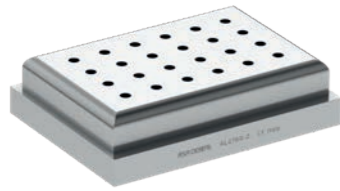

AL2760-2

con bordo, 24 fori FG/CA
(frese piccole/grandi)

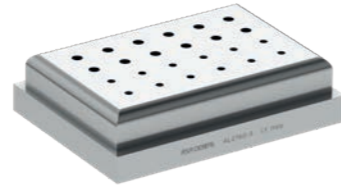

AL2760-3

48 fori CA
(frese grandi)



AL2762-2

Silicone colorato con coperchio in plastica

coperchio
non autoclavabile



AL2761-U

autoclavabile
silicone alimentare atossico

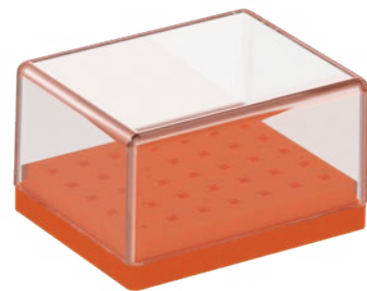

**Arancio
S2760-A**

autoclavabile
silicone alimentare atossico

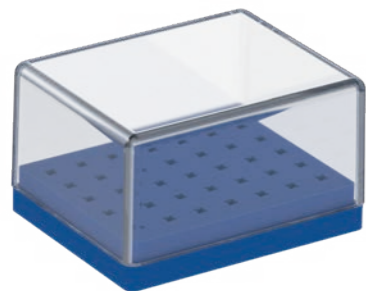

**Blu
S2760-C**

COMPATTATORI PER OSSO



**1
MV1230-1**



**2
MV1230-2**

PINZETTE PER MARCARE LE TASCHE

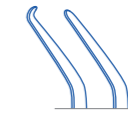

**1 (Crane-Kaplan)
Goldman-Fox
15 cm
0650-1**

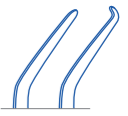

**2 (Crane-Kaplan)
Goldman-Fox
15 cm
0650-2**

PINZETTE CHIRURGICHE

PINZETTE CHIRURGICHE
pinzette per sutura

PINZETTE PER MEMBRANA

PINZETTE PORTA IMPIANTI



1 Adson 12 cm 0620-1
 1 Adson 1x2 12 cm 0621-1
 1 Semken-Taylor 12,5 cm 0630-1
 2 Semken-Taylor 12,5 cm 0630-2



16 cm PR0625-2 Perfection
 17 cm PR0625-3 Perfection



10,5 cm 0660-1
 9 cm 0660-2 con punte ad anello



16,5 cm 0661-1
 14,5 cm 0661-2
 14,5 cm 0661-3

KIT DI STRUMENTI PER CHIRURGIA IMPLANTARE

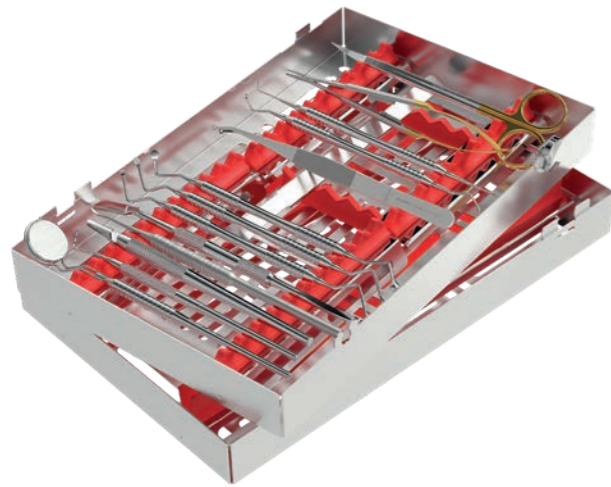

Kit chirurgica implantare
SPR2781-I

ML2101	manico per specchietti	
2230-5	specchietto doppio	5
0702L-15	sonda millimetrica parodontale	CP-15
0350-5	manico per bisturi e lama	5
PR1857-1	dissetto	
MV1851-PR3	scollaperiostio Prichard	PR3
1855-23	divaricatore Seldin	23
ML2001-85	cucchiaio alveolare Lucas	85
ML2001-87	cucchiaio alveolare Lucas	87
ML2001-88	cucchiaio alveolare Lucas	88
PR0625-2	pinzetta chirurgica	
ML1806-2RL	strumento parodontale	2R/2L
ML1806-4RL	strumento parodontale	4R/4L
PR0460-15TC	porta aghi Castroviejo	
0309-2TC	forbicina per gengive	2TC
2780-1R	cassetta portastrumenti	

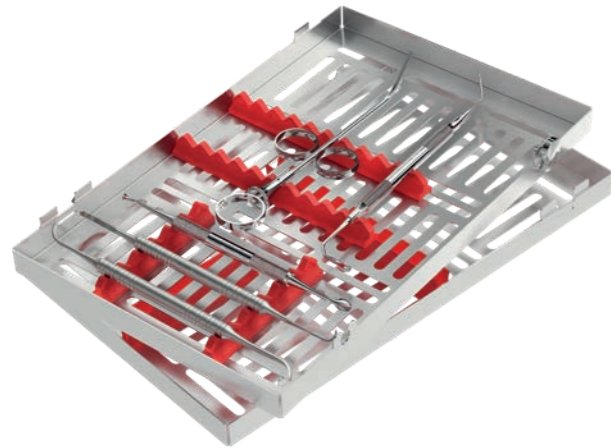

Kit grande rialzo del seno
SPR0496

PR1859-1	strumento per il seno mascellare	
PR1859-2	strumento per il seno mascellare	
MV1231-1	applicatore per osso	
0490-1	iniettore per osso	
MV1856-2	strumento per il seno mascellare	2
2770-3R	cassetta portastrumenti	

KIT DI STRUMENTI PER CHIRURGIA IMPLANTARE

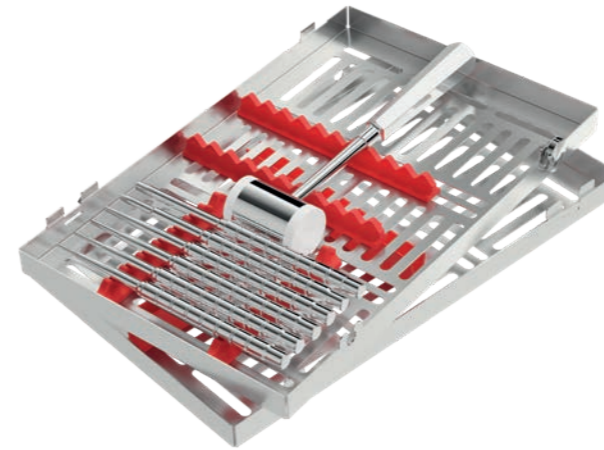

Kit mini rialzo del seno
SPR0495

0495-1	osteotomo	
0495-2	osteotomo	
0495-3	osteotomo	
0495-4	osteotomo	
0495-5	osteotomo	
0495-6	osteotomo	
1881	martello Mead	
2770-1R	cassetta portastrumenti	

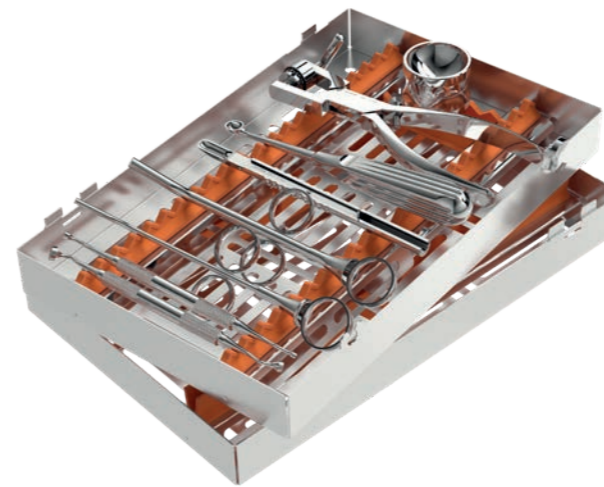

288 x 182 x h. 60 mm
S2780-IMP

1030-4	mortaio per osso	
1846	macinatore per osso	
2014-3	cucchiaio alveolare	3
0494-1	raschietto per osso retto	
0490-2	iniettore per osso	
0490-1	iniettore per osso	
MV1230-1	compattatore per osso	1
MV1230-2	compattatore per osso	2
2780-1A	cassetta portastrumenti	

KIT DI STRUMENTI PER CHIRURGIA IMPLANTARE



Kit mini rialzo del seno
S0498-8

0498-1B4	osteotomo concavo	1B4
0498-2C4	osteotomo concavo	2C4
0498-30B4	osteotomo angolare	30B4
0498-PF4	osteotomo piatto	PF4
1902-2	scaler Towner-Jacquette	U15/30
1809-1	scaler universale Goldman-Fox	1
1831-32	curette Jacquette	31/32
2001-87	cucchiaio alveolare Lucas	87
S2702	vassoio forato completo di griglia	



kit Goracci
S3001-20

0300-1	forbicina per gengive retta	
0601-1	pinzetta per medicazione Flagg	
0704-23D2	sonda doppia	23/17A
0903-2	spatola doppia per cemento	2
1101-2	spatola Heidemann	2
1200-2	otturatore doppio	2
1202-1L	otturatore doppio	1L
1202-2L	otturatore doppio	2L
1211-1T	otturatore Tanner	1T
1301	applicatore per sottofondo	
1500-02	strumento per modellare Hollenback	1/2
1600-1	cleoide-discoide	1
1601-1	finitore per bordi gengivali	26
1601-2	finitore per bordi gengivali	27
1700-1	escavatore doppio	1
1700-2	escavatore doppio	2
1700-3	escavatore doppio	3
1700-4	escavatore doppio	4
2102-IN	manico per specchietto	
2200-5	specchietto piano	5
S2721-2	vassoio con base forata completo di griglia	

KIT DI STRUMENTI PER CHIRURGIA IMPLANTARE



S3003-9

MV1850-M9	scollaperiostio Molt	M9
MV1851-PR3	scollaperiostio Prichard	PR3
MV1850-GF	scollaperiostio Goldman-Fox	GF
MV1803-D	bisturi Kirkland	15K/16K
1881	martello Mead	
0446TH-14TC	Porta aghi Castroviejo	
0435-17TC	Porta aghi Mathieu	
0350-3	manico per bisturi	3
S2722-1	vassoio forato completo di griglia	



S3003-11

0350-3	manico per bisturi	3
2602-1	divaricatore Sternberg	
0304-2	forbicine Goldman-Fox	2
MV1850-M9	scollaperiostio Molt	M9
MV1851-PR3	scollaperiostio Prichard	PR3
0415-15TC	porta aghi Crile-Wood	
0631-1	pinzetta chirurgica Semken Taylor	1
0700-23	sonda	23
2102-IN	manico per specchietto	
2200-5	specchietto piano	5
0351-11	lame per bisturi (100 pz)	11
S2722-1	vassoio forato completo di griglia	

CONSERVATIVA

MADE IN ITALY



MAKE PEOPLE SMILE

Questa l'idea, semplice e potente, che guida ogni nostra decisione. Ogni volta che scegliamo i materiali, le tecnologie, le forme e i processi produttivi ci assicuriamo che aiutino i professionisti del settore dentale a far sorridere le persone in ogni angolo del mondo. I nostri strumenti per l'odontoiatria conservativa sono il risultato di un *modus operandi* ponderato, preciso e funzionale, condotto da esperti del settore attraverso tecnologie avanzate. È così che produciamo escavatori resistenti, rifinitori precisi, brunitori efficaci, strumenti per isolamento innovativi e tutti gli altri prodotti che consentono ai medici di garantire risultati esteticamente impeccabili e funzionalmente superiori.

F2	Diga Vision
F6	Uncini per diga
F11	Strumenti per diga
F16	Escavatori
F21	Strumenti per preparazione cavità
F23	Spingi amalgama
F23	Mortai per amalgama
F25	Spatole
F28	Otturatori
F38	Strumenti per modellare
F41	Strumenti operativi
F42	Strumenti per corone
F46	Pinze emostatiche
F47	Forbicine
F48	Matrici
F50	Strumenti per composito

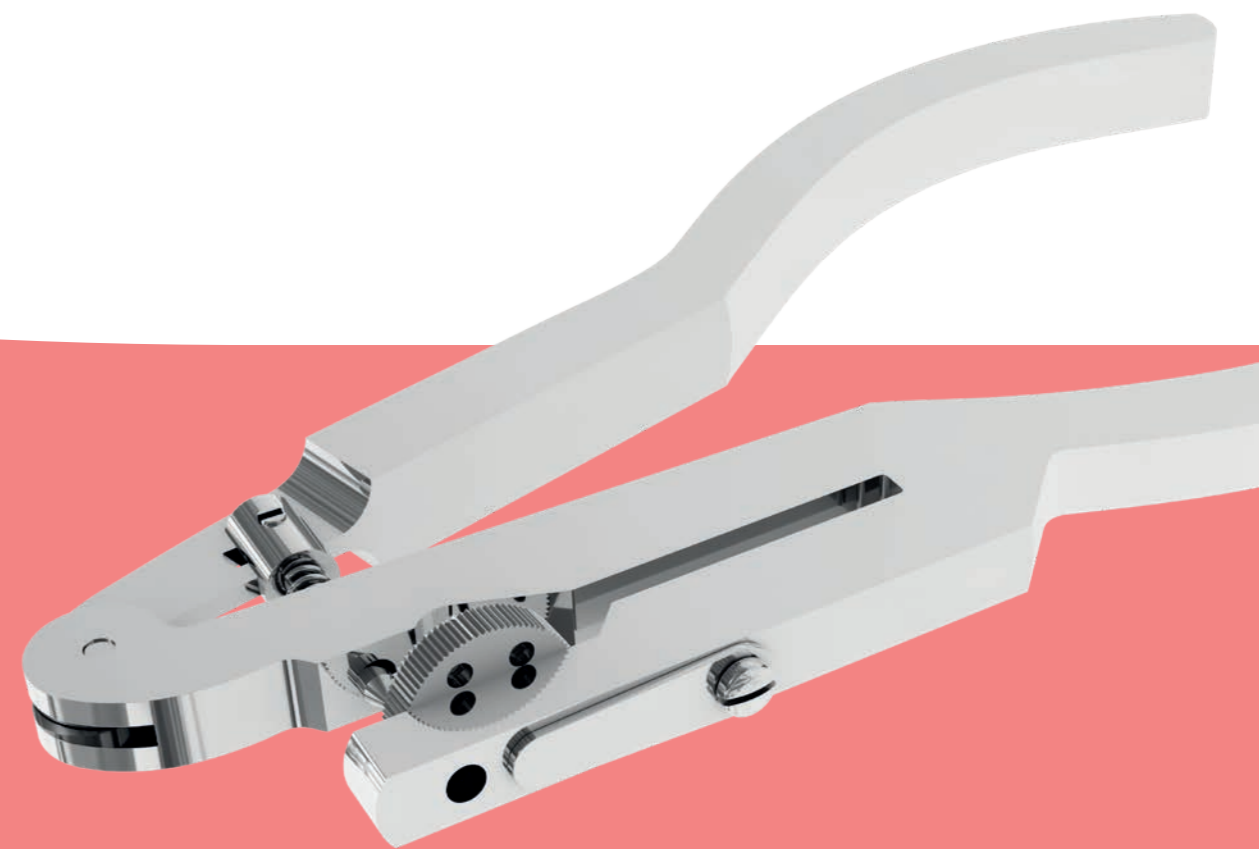



VISION® SHADE

Diga dentale
 pack 60 dighe di gomma
 (colore nero, profumo menta)
 185x130 mm



VS3045

Telaio per diga
 in acciaio inox
 10x15 cm

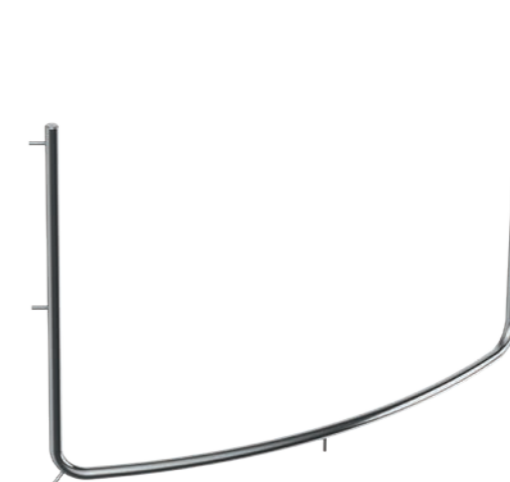

VV3040-2

Vassoio magnetico
 in acciaio inox



VV2731-6

Vassoio magnetico
 in acciaio inox con 6 uncini

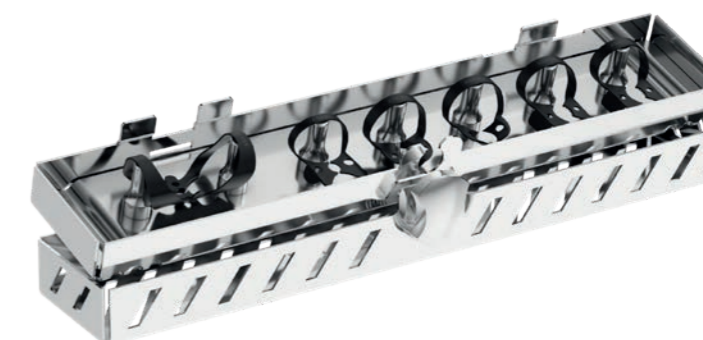

SVS2731-6

VISION®
 dental dam reinvented

VISION

VISION® SHADE

Uncini



210
con alette
ideale per denti anteriori
VS3051-210



12A
con alette, dentellato per
molari inferiori destri/superiori sinistri
VS3052-12A



W4
senza alette
per molari superiori/inferiori
VS3052-W4



2
con alette
per premolari inferiori / superiori
VS3052-2



13A
con alette, dentellato per
molari inferiori sinistri/anteriori destri
VS3052-13A



W8
senza alette
per molari superiori/inferiori
VS3052-W8

Pinza per uncini
in acciaio inox



VV3030

Pinza foradiga
in acciaio inox



VV3033

Dima di foratura
in acciaio inox

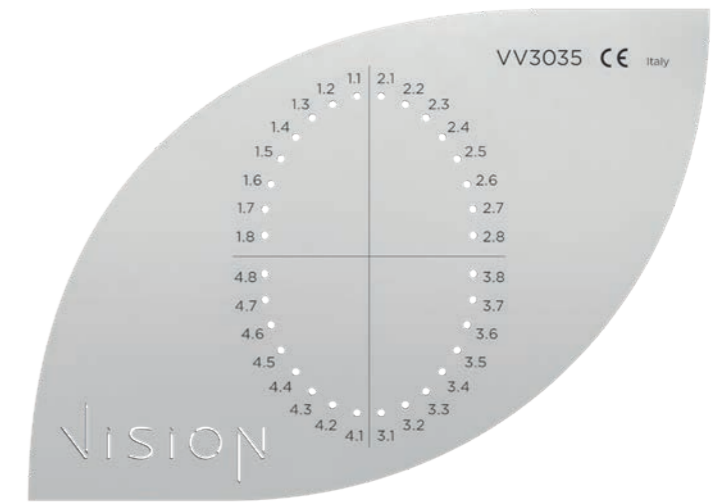

VV3035

Pennarello
per uso alimentare



VVPEN

Kit Vision Shade



SVS3000

NUMERAZIONE DEI DENTI

Denti mascellari	Forme
18 17 16	4 W4 8 W8 8A W8A 12A 14 14T W14 14A W14A 26 51 205 202
15 14	0 W0 1 1T W1 2A 2AT W2A 29
13 12 11 21 22 23	9 9T 212 210
24 25	0 W0 1 1T W1 2A 2AT W2A 29
26 27 28	4 W4 8 W8 8A W8A 13A 14 14T W14 14A W14A 26 51
Denti mandibolari	Forme
38 37 36	3 W3 7 W7 8A W8A 13A 14 14T W14 14A W14A
35 34	0 W0 2A 2AT W2A 2 2T W2 29
33 32 31 41 42 43	00 9 9T 212 210
44 45	0 W0 2 2T W2 2A -2AT W2A 29
46 47 48	3 W3 7 W7 12A 14 14T W14 14A W14A

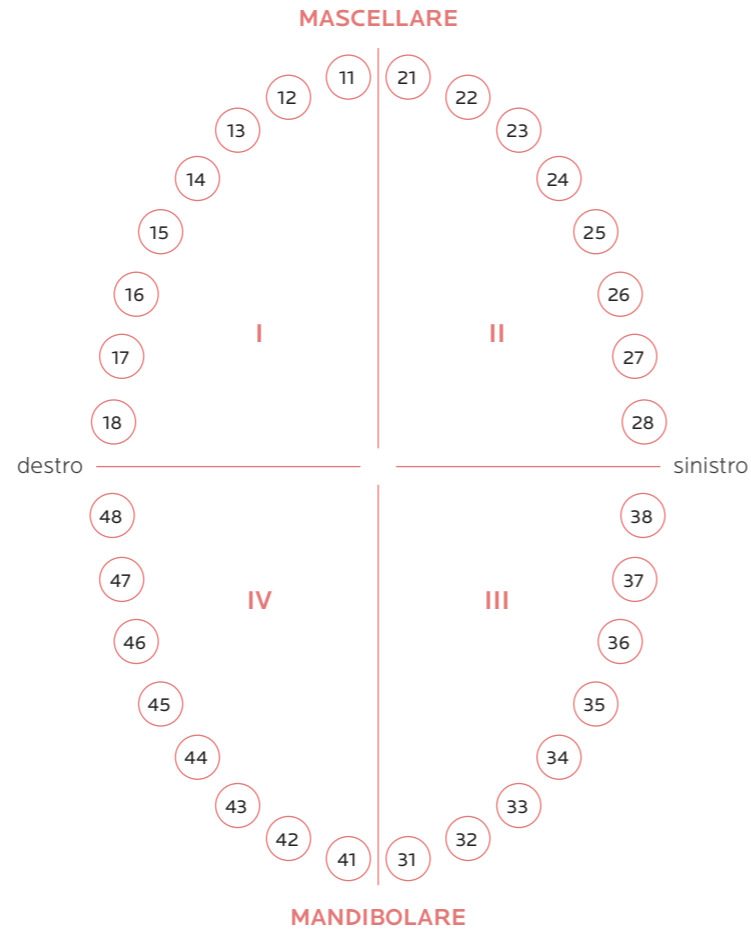

CLASSIFICAZIONE

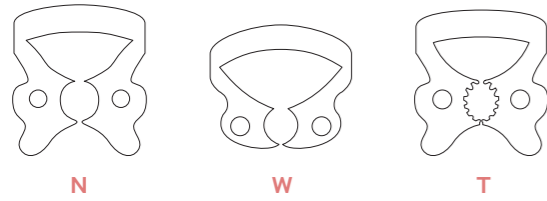

- N** Standard (uncino con alette)
- W** Wingless (uncino senza alette)
- T** Tiger (uncino con branche dentellate)

UNCINI PER DIGA Anteriori

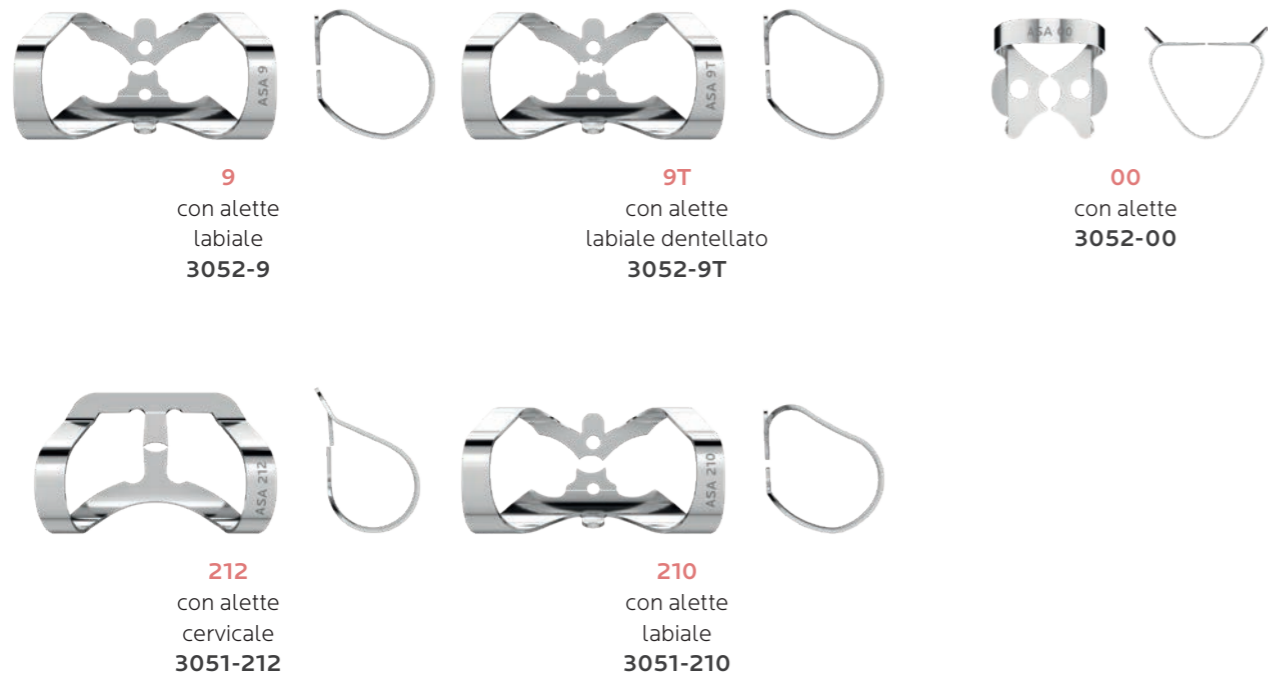

Premolari

per denti di piccole dimensioni, allungati o stretti



per uso generale, con alette adattabili alle curvature delle linee gengivali



per premolari, con colletto lungo



Premolari

per premolari inferiori versatili



2
con alette
3052-2

2T
con alette,
dentellato
3052-2T



W2
senza alette
3052-W2

principalmente per premolari mandibolari



29
senza alette
3051-29

60
senza alette
3050-60

Molari

per molari inferiori piccoli



3
con alette
3052-3

W3
senza alette
3052-W3

Molari

per molari inferiori di forma quadrata



7
con alette
3052-7

W7
senza alette
3052-W7

per radici di molari



8A
con alette
3052-8A

W8A
senza alette
3052-W8A

Per molari tondi, parzialmente rotti, sottodimensionati o inclinati



14
con alette
3052-14

14T
con alette,
dentellato
3052-14T



W14
senza alette
3052-W14

per molari superiori



26
senza alette
3051-26

51
senza alette
3051-51

Molari

per molari piccoli
con colletti tondi



4
con alette
3052-4



W4
senza alette
3052-W4



per molari superiori
a forma tonda



8
con alette
3052-8



W8
senza alette
3052-W8



per molari
parzialmente rotti



12A
con alette,
dentellato
3052-12A



13A
con alette,
dentellato
3052-13A



per molari grandi,
parzialmente rotti,
di forma irregolare
o inclinati



14A
con alette
3052-14A



W14A
senza alette
3052-W14A



per molari grandi
superiori



202
con alette
3051-202



205
con alette
3051-205



STRUMENTI PER DIGA

AsaLady

prodotti ergonomici progettati su misura
per le mani femminili:

- manici ridotti e più leggeri
 - anelli delle dita più piccoli
 - dimensioni ridotte
- codici con prefissi "W" o "SW"

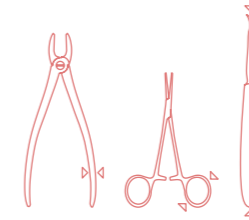

Diga in lattice

confezionata in sottovuoto
36 pz / confezione

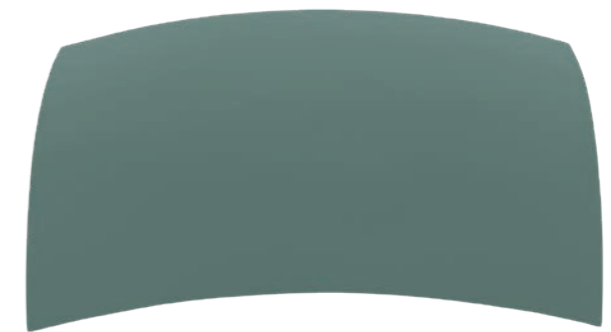

15x15 cm (6"x6")
3045

Pinza foradiga



Ainsworth
17 cm
3032



Ainsworth
17 cm
W3036



Ivory
16,2 cm
3033

STRUMENTI PER DIGA

Telaio per diga
acciaio inox

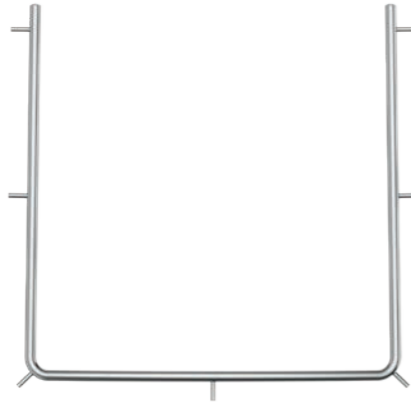

10x10 cm
3040-1

Diga inserita su molare superiore

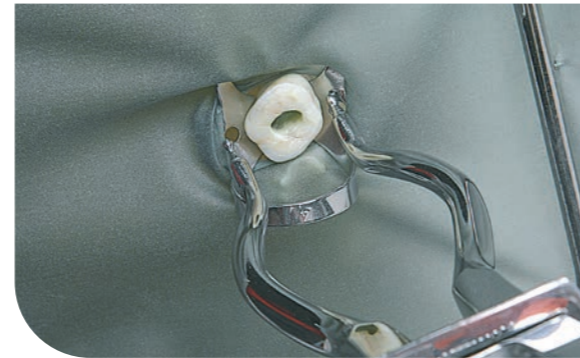

Telaio per diga
plastica sterilizzabile
compatibile con
esame radiografico

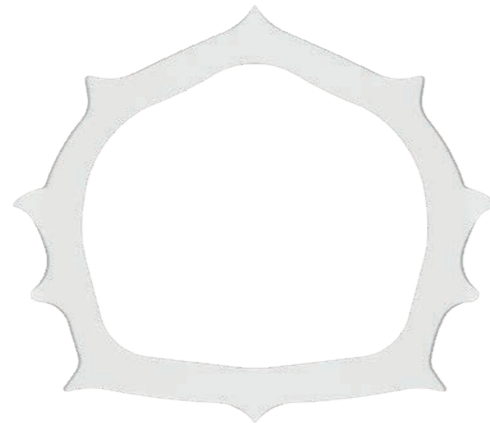

3041-1

Pinze per uncini



Ivory leggera
17 cm
3030



Ivory leggera
16 cm
W3035



Brewer
17,5 cm
3031



Stoke
17,5 cm
3034

KIT DI STRUMENTI PER DIGA



S3000

Set di strumenti per diga realizzato secondo le indicazioni del Prof. Guido Goracci, titolare della Cattedra di Odontoiatria Conservatrice presso l'Università degli Studi di Roma "La Sapienza".

3040-1	telaio per diga in acciaio inox	
3031	pinza per uncini Brewer	
3033	pinza foradiga Ivory	
3050-60	uncino senza alette per premolari	60
3051-26	uncino senza alette per molari	26
3051-51	uncino senza alette per molari	51
3051-29	uncino senza alette per premolari	29
3051-202	uncino con alette per molari	202
3051-205	uncino con alette per molari	205
3051-212	uncino cervicale con alette	212
3051-210	uncino labiale con alette	210
2731-1	vassoio porta uncini in acciaio inox	
2720-L	vassoio in acciaio inox	
2720-U	coperchio in acciaio inox	
2730-3	griglia portastrumenti in acciaio inox	

Griglia porta strumenti per diga

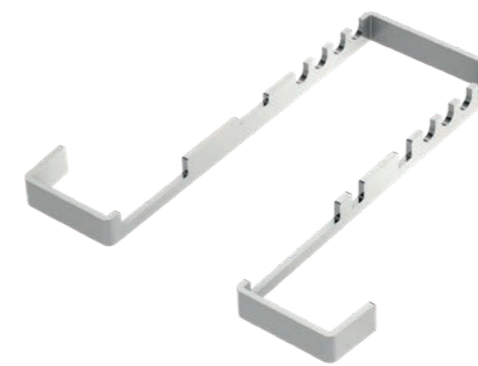

2730-3

KIT DI STRUMENTI PER DIGA



S2731-1

vassoio porta uncini in acciaio inox completo di 8 uncini

3050-60	uncino senza alette per premolari	60
3051-26	uncino senza alette per molari	26
3051-51	uncino senza alette per molari	51
3051-29	uncino senza alette per premolari	29
3051-202	uncino con alette per molari	202
3051-205	uncino con alette per molari	205
3051-212	uncino cervicale con alette	212
3051-210	uncino labiale con alette	210
2731-1	vassoio porta uncini in acciaio inox	

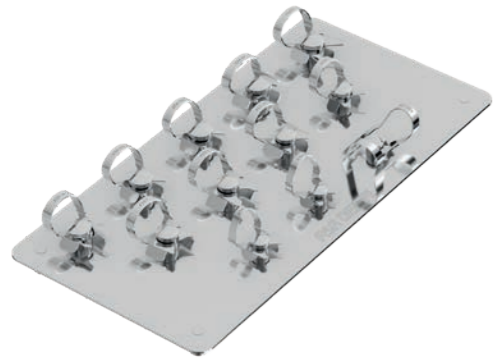

S2731-12

vassoio porta uncini in acciaio inox completo di 12 uncini

3051-212	uncino cervicale con alette	212
3052-00	uncino con alette per premolari	00
3052-0	uncino con alette per premolari	0
3052-1	uncino con alette per premolari	1
3052-2A	uncino con alette per premolari	2A
3052-3	uncino con alette per molari	3
3052-7	uncino con alette per molari	7
3052-8	uncino con alette per molari	8
3052-8A	uncino con alette per radici di molari	8A
3052-12A	uncino dentellato con alette per molari	12A
3052-13A	uncino dentellato con alette per molari	13A
3052-14	uncino con alette per molari	14
2731-1	vassoio porta uncini in acciaio inox	



2731-1

vassoio porta uncini in acciaio inox (senza uncini)

MANICI

PUNTA SINGOLA

Asa35
(acciaio inox)
ø 3,5 mm



Asa60
(acciaio inox)
ø 6,0 mm



Ottagonale
(acciaio inox)
ø 5,5 mm



PUNTA DOPPIA

Asa60
(acciaio inox)
ø 6,0 mm



Asa Light MV
(acciaio inox, vuoto)
ø 8,0 mm



Leonardo ML
(acciaio inox)
ø 7,0 mm



Ottagonale
(acciaio inox)
ø 5,5 mm



● **Alu80**
(aluminum, vuoto)
ø 8,0 mm



● **AsaWave RC**
(resina plastica in PPSU e anima in acciaio)
ø 7,5 / 14,5 mm



COME USARE LE INFORMAZIONI

- 1/2 Wedelstaedt → modello + nome scientifico
- MV1604-02 → codice Asa Dental
- Asa Light MV → manico

AsaLady

prodotti ergonomici progettati su misura per le mani femminili:

- manici ridotti e più leggeri
- anelli delle dita più piccoli
- dimensioni ridotte

codici con prefissi "W" o "SW"

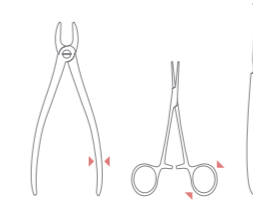

vista dall'alto



vista laterale

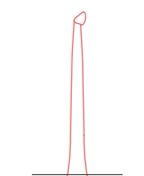

vista frontale



ESCAVATORI
Cucchiai

ESCAVATORI
Cucchiai

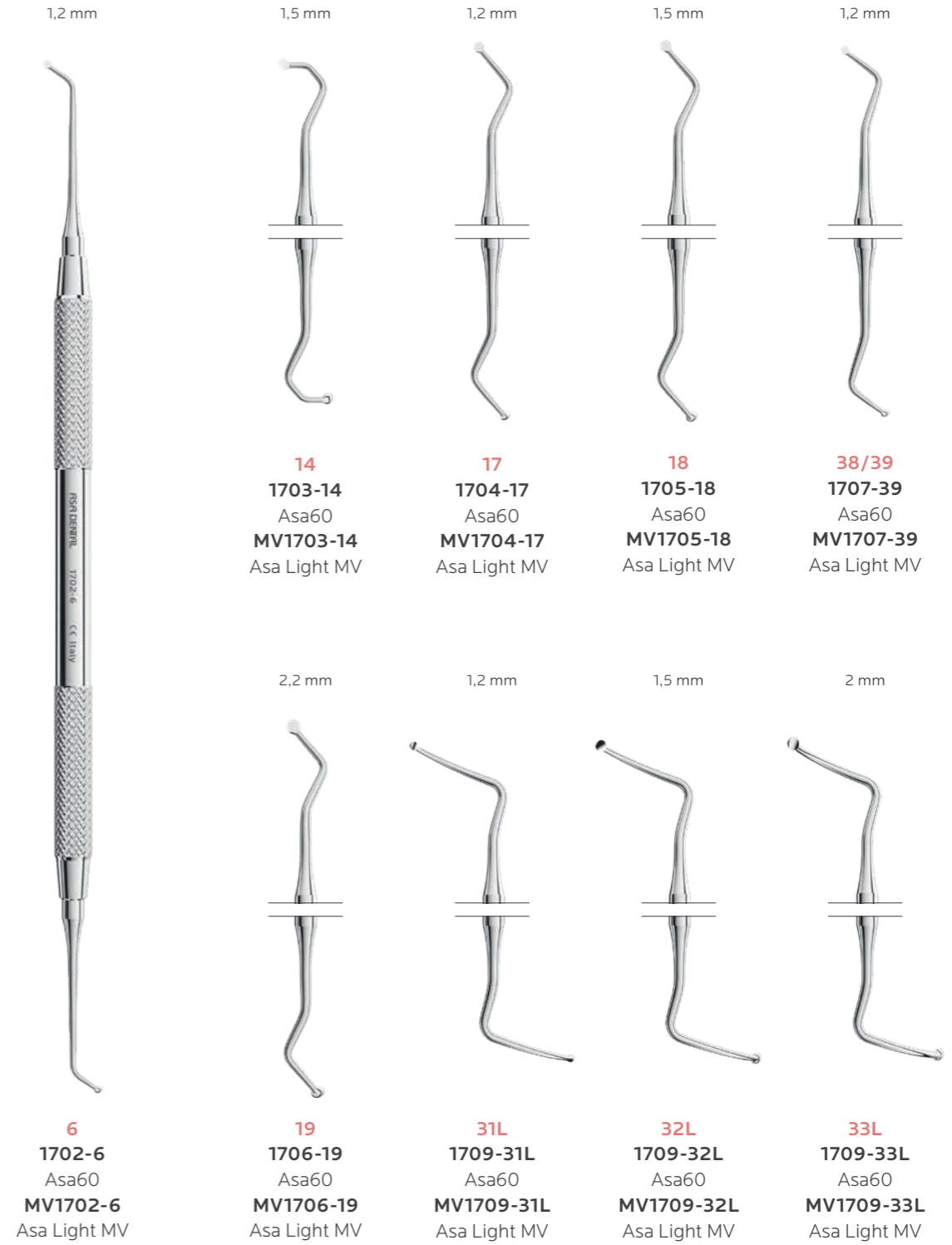
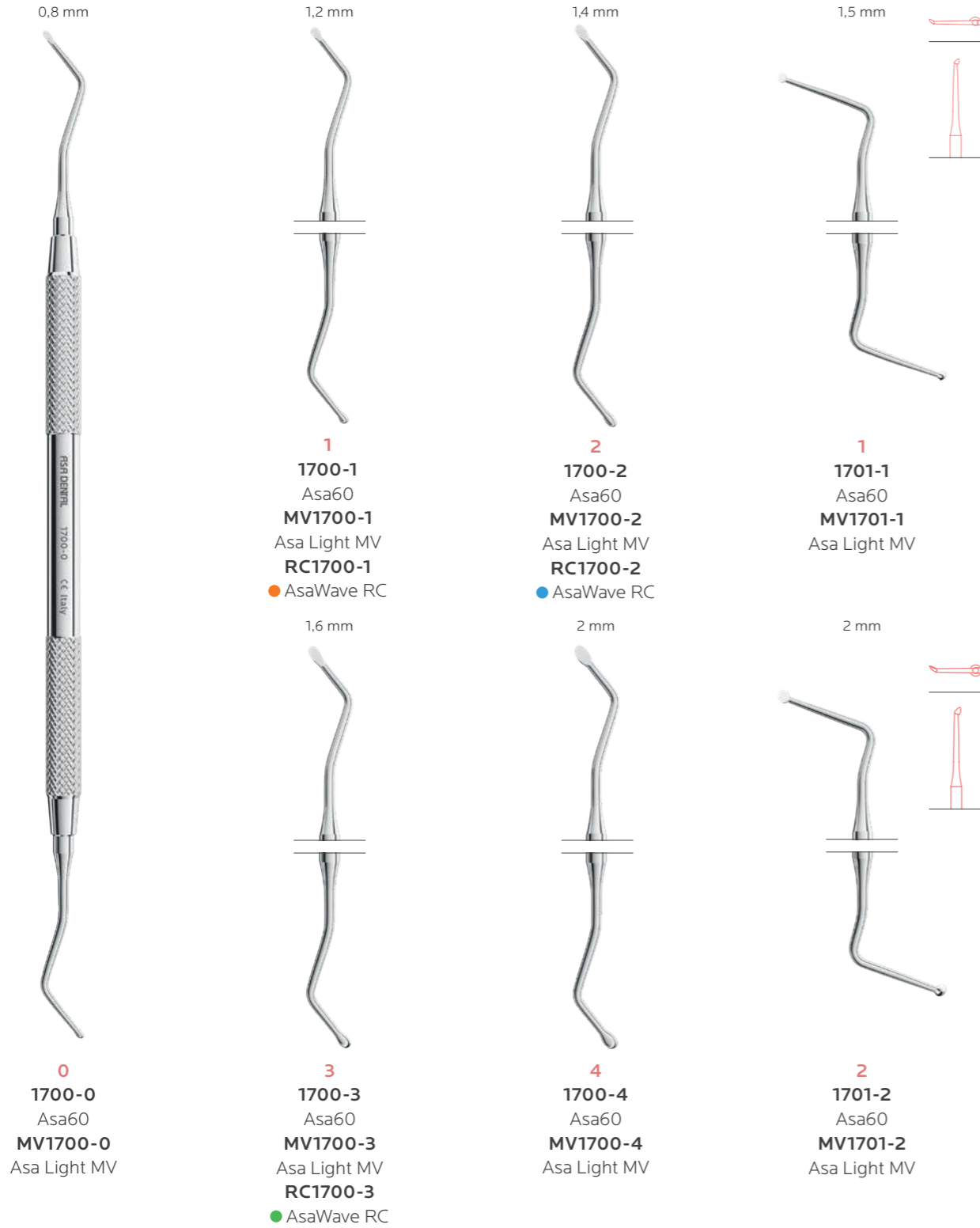

Set da 5



Modello	Codice Set	Manico
0 · 1 · 2 · 3 · 4	SMV1700	Asa Light MV
0 · 1 · 2 · 3 · 4	S1700	Asa60
0	S1700-0	Asa60
1	S1700-1	Asa60
2	S1700-2	Asa60
3	S1700-3	Asa60
4	S1700-4	Asa60

ESCAVATORI
Cucchiai ovali

1,2 mm 1,5 mm 2 mm



17W
1704-17W
Asa60
MV1704-17W
Asa Light MV

18W
1705-18W
Asa60
MV1705-18W
Asa Light MV

19W
1706-19W
Asa60
MV1706-19W
Asa Light MV

ESCAVATORI
ASH

1 mm 1,4 mm



243
1711-243
Asa60
ML1711-243
Leonardo ML

G2
1711-G2
Asa60
ML1711-G2
Leonardo ML

ESCAVATORI
Modello SS. White

Set da 6



Modello	Codice Set	Manico
5 · 14 · 17 · 18 · 19 · 20	S1710-6	Asa60
5 · 14 · 17 · 18 · 19 · 20	SML1710-6	Leonardo ML

1 mm 1,2 mm 1 mm 1,2 mm 2 mm



5
1710-5
Asa60
ML1710-5
Leonardo ML

14
1710-14
Asa60
ML1710-14
Leonardo ML

17
1710-17
Asa60
ML1710-17
Leonardo ML

18
1710-18
Asa60
ML1710-18
Leonardo ML



19
1710-19
Asa60
ML1710-19
Leonardo ML

20
1710-20
Asa60
ML1710-20
Leonardo ML

ESCAVATORI
Darby-Perry

0,8 mm	0,8 mm	1 mm	1 mm	1 mm	2 mm
					
1 Darby-Perry ML1711-1 Leonardo ML 1711-1 Asa60	2 Darby-Perry 1711-2 Asa60 ML1711-2 Leonardo ML	11 Darby-Perry 1711-11 Asa60 ML1711-11 Leonardo ML	12 Darby-Perry 1711-12 Asa60 ML1711-12 Leonardo ML	21 Darby-Perry 1711-21 Asa60 ML1711-21 Leonardo ML	42 Darby-Perry ML1711-42 Leonardo ML 1711-42 Asa60
	1,2 mm	1,6 mm	1,6 mm	2 mm	
					
	22 Darby-Perry 1711-22 Asa60 ML1711-22 Leonardo ML	31 Darby-Perry 1711-31 Asa60 ML1711-31 Leonardo ML	32 Darby-Perry 1711-32 Asa60 ML1711-32 Leonardo ML	41 Darby-Perry 1711-41 Asa60 ML1711-41 Leonardo ML	

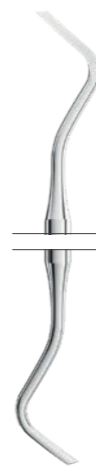
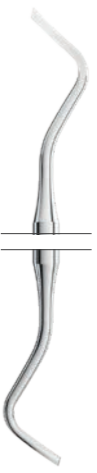
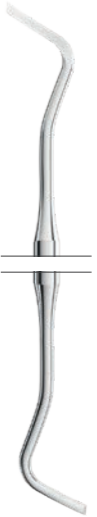
STRUMENTI PER PREPARAZIONE CAVITÀ
Finitori per bordi gengivali

				
1 Black/26 distale 1601-1 Asa60 MV1601-1 Asa Light MV	2 Black/27 mesiale 1601-2 Asa60 MV1601-2 Asa Light MV	3 Black/28 distale 1601-3 Asa60 MV1601-3 Asa Light MV	4 Black/29 mesiale 1601-4 Asa60 MV1601-4 Asa Light MV	2 Black/79-80 mesiale 1602-2 Asa60 MV1602-2 Asa Light MV

STRUMENTI PER PREPARAZIONE CAVITÀ
Scalpellini



1 Black/53-54
1603-1
Asa60
MV1603-1
Asa Light MV

2 Black/51-52
1603-2
Asa60
MV1603-2
Asa Light MV

STRUMENTI PER PREPARAZIONE CAVITÀ
Scalpellini



1/2 Wedelstaedt
1604-02
Asa60
MV1604-02
Asa Light MV

3/4 Wedelstaedt
1604-04
Asa60
MV1604-04
Asa Light MV

5/6 Wedelstaedt
1604-06
Asa60
MV1604-06
Asa Light MV

SPINGI AMALGAMA

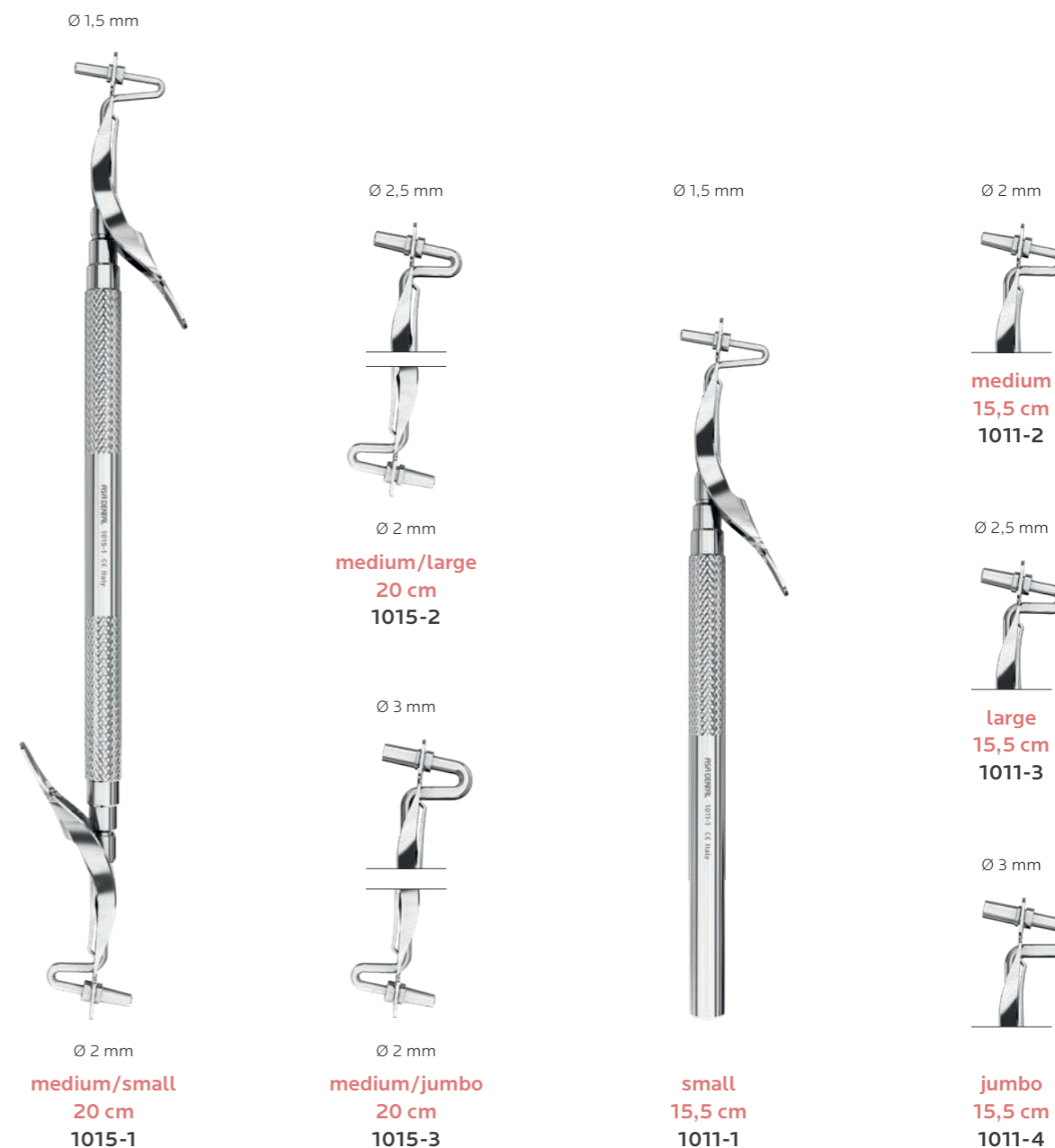

MORTAI PER AMALGAMA
solo sterilizzazione a freddo



Ø 3,5 cm
h. 3,5 cm
1030-1

Ø 2 cm
h. 4 cm
1030-2

Ø 2 cm
h. 2,5 cm
1030-3

SPINGI AMALGAMA

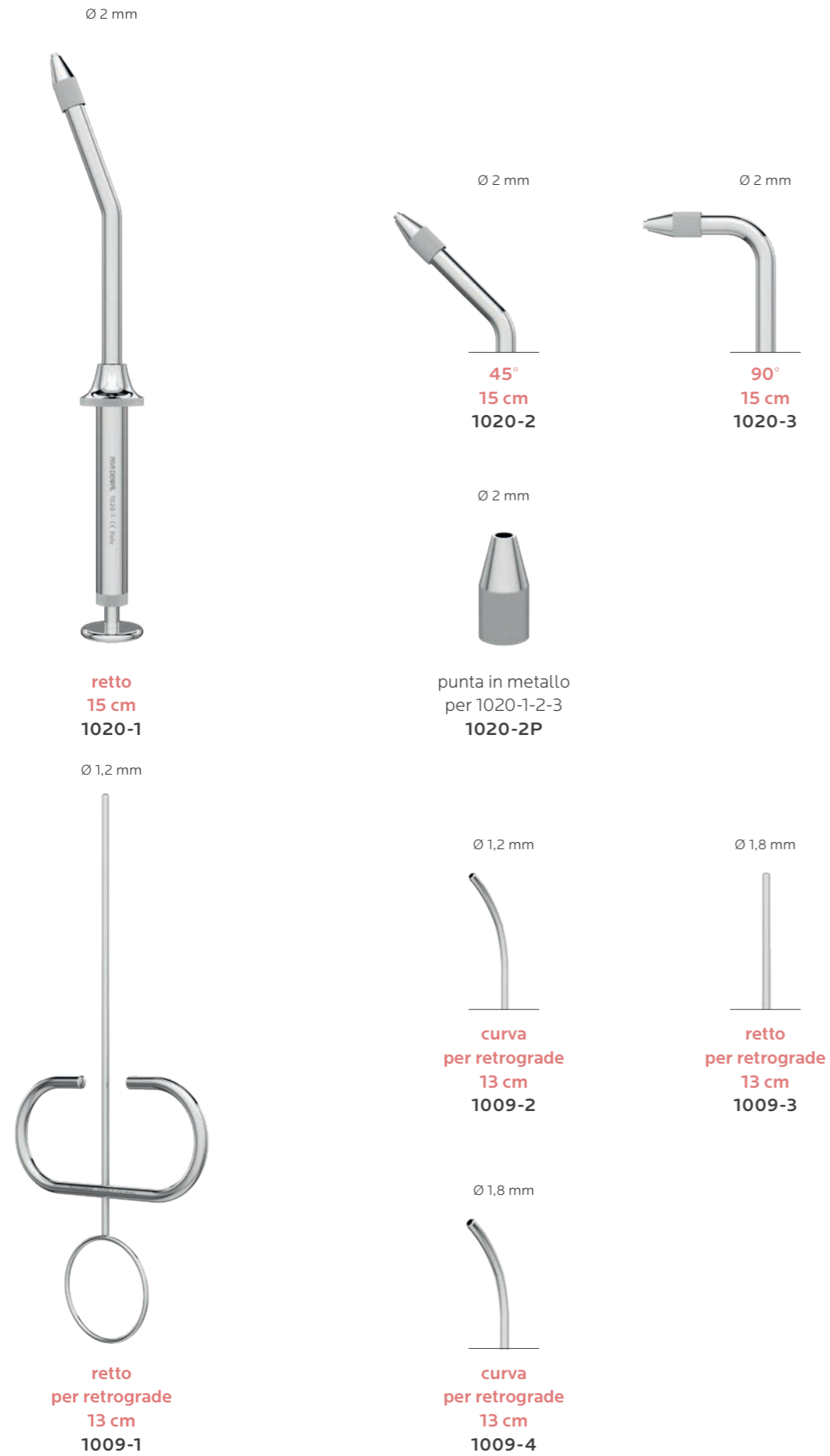

SPATOLE PER CEMENTO

Set da 5



Modello	Codice Set
1	S0903-1
2	S0903-2
3	S0903-3

Piastra in vetro per miscelazione

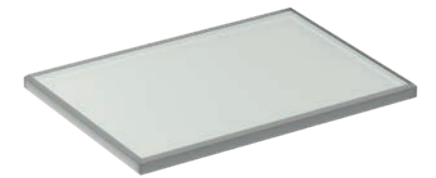

8x12x0,5 cm
0999-1

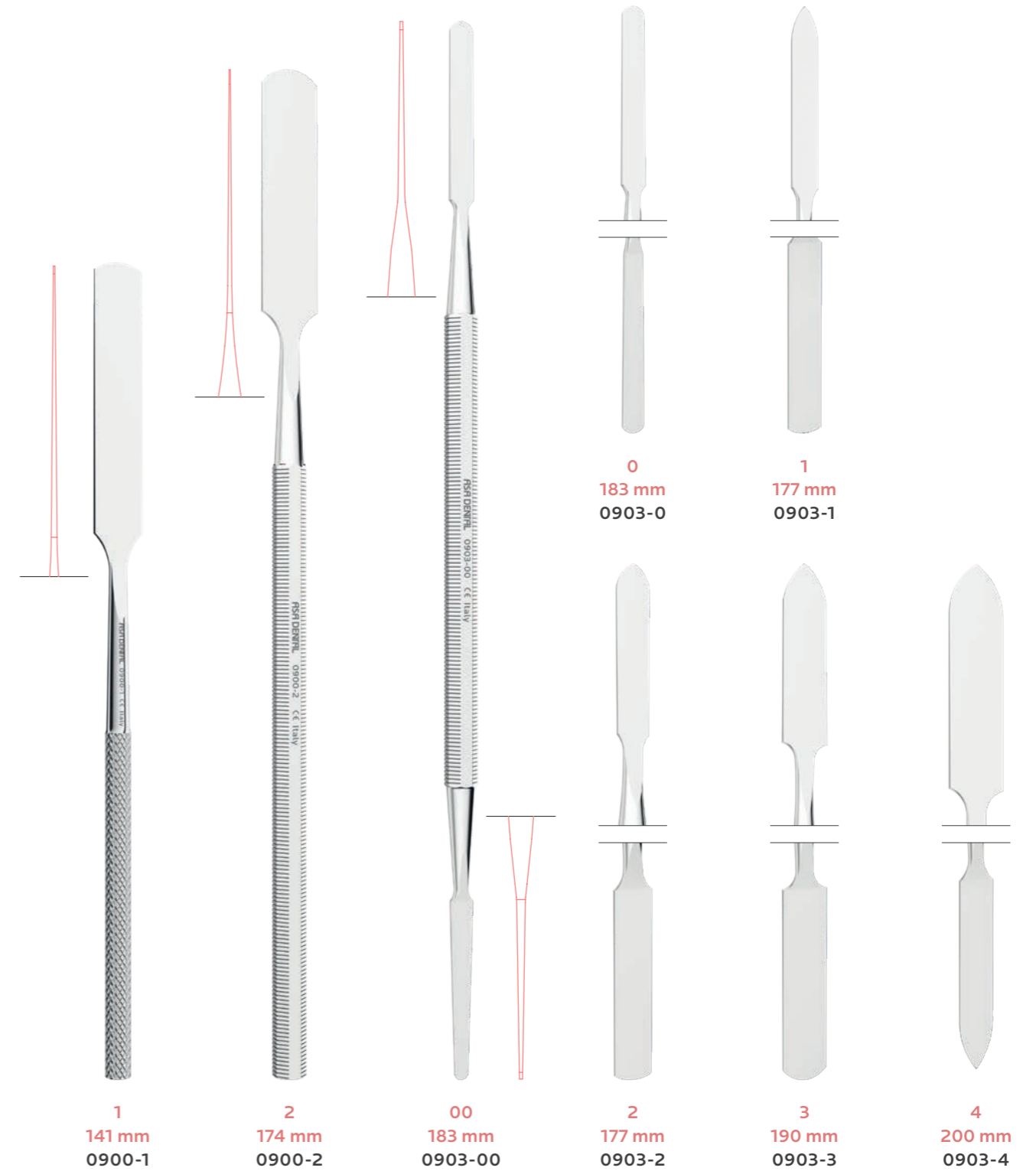

SPATOLE HEIDEMANN

SPATOLE HEIDEMANN

SPATOLE HEIDEMANN
con punte rivestite al nitruro di titanio

Set da 5

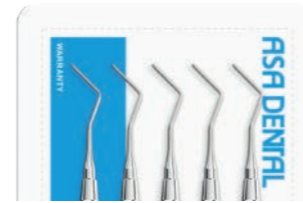

Modello	Codice Set	Manico
1	S1102-1	Asa60
2	S1102-2	Asa60
3	S1102-3	Asa60



1 1100-1 Ottagonale
2 1100-2 Ottagonale
3 1100-3 Ottagonale
1 1101-1 Asa60
2 1101-2 Asa60
3 1101-3 Asa60

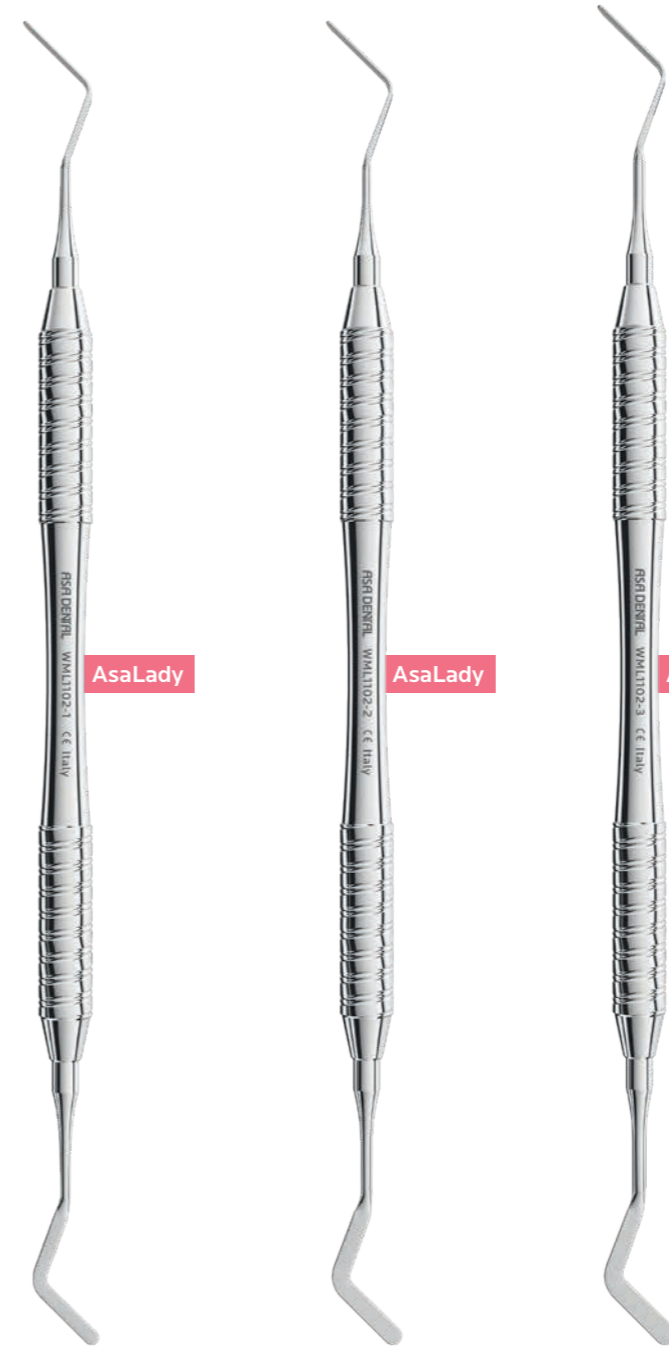

1 ML1102-1/WML1102-1 Leonardo ML
1102-1 Asa60
MV1102-1 Asa Light MV
RC1102-1 AsaWave RC
2 WML1102-2 Leonardo ML
1102-2 Asa60
MV1102-2 Asa Light MV
RC1102-2 AsaWave RC
3 WML1102-3 Leonardo ML
1102-3 Asa60
MV1102-3 Asa Light MV
RC1102-3 AsaWave RC



1 1102T-1 Asa60
2 1102T-2 Asa60
3 1102T-3 Asa60

OTTURATORI PER AMALGAMA

con punte rivestite al nitruro di titanio

Set da 5



Modello	Codice	Codice Set	Manico
1	1200T-1	S1200T	Asa60
2	1202T-2	S1200T	Asa60
1	1204T-1	S1200T	Asa60
1	1102T-1	S1200T	Asa60
2	1102T-2	S1200T	Asa60

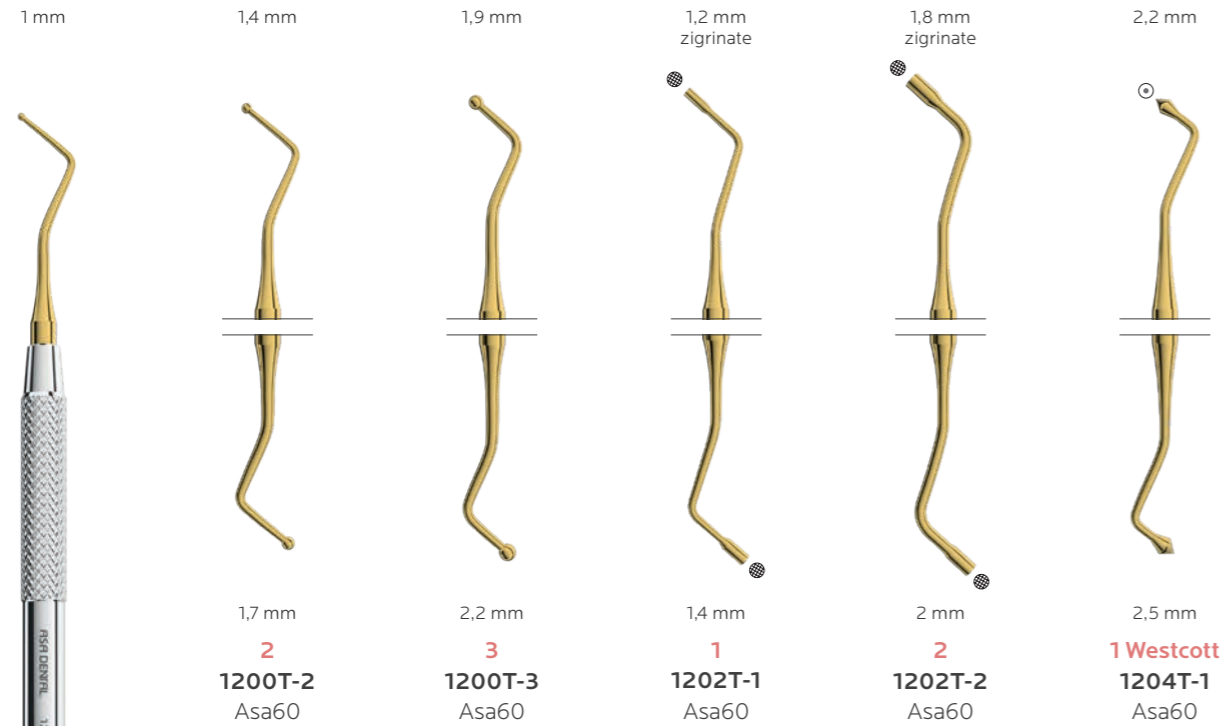

1200T-2

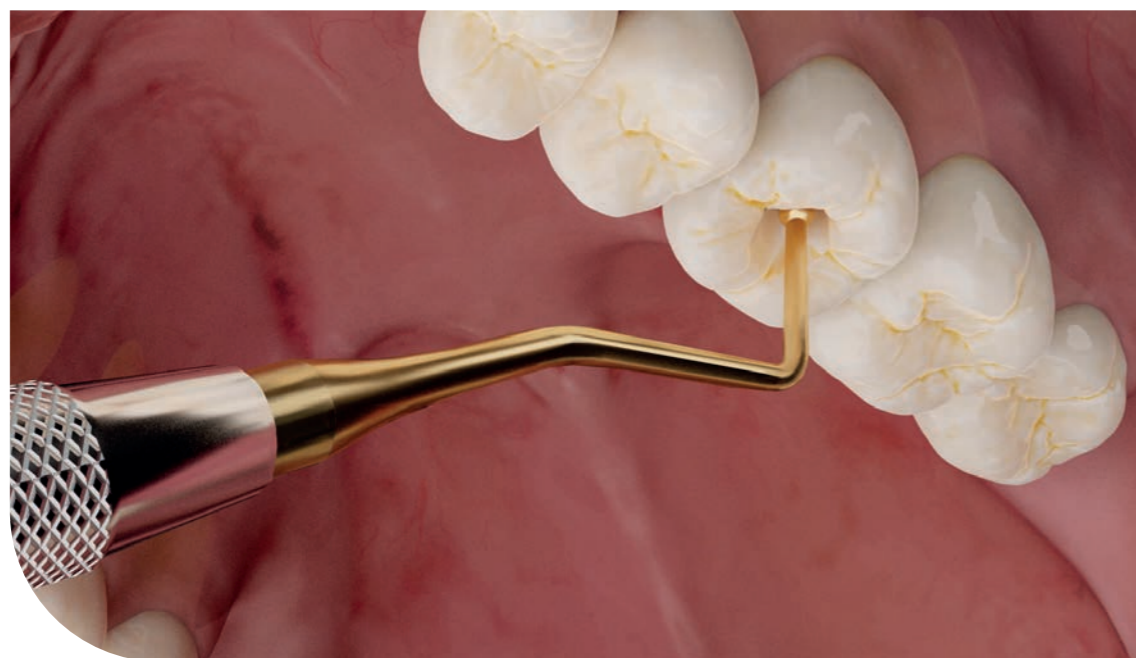

1,2 mm
1
1200T-1
Asa60

OTTURATORI PER AMALGAMA



Set da 5

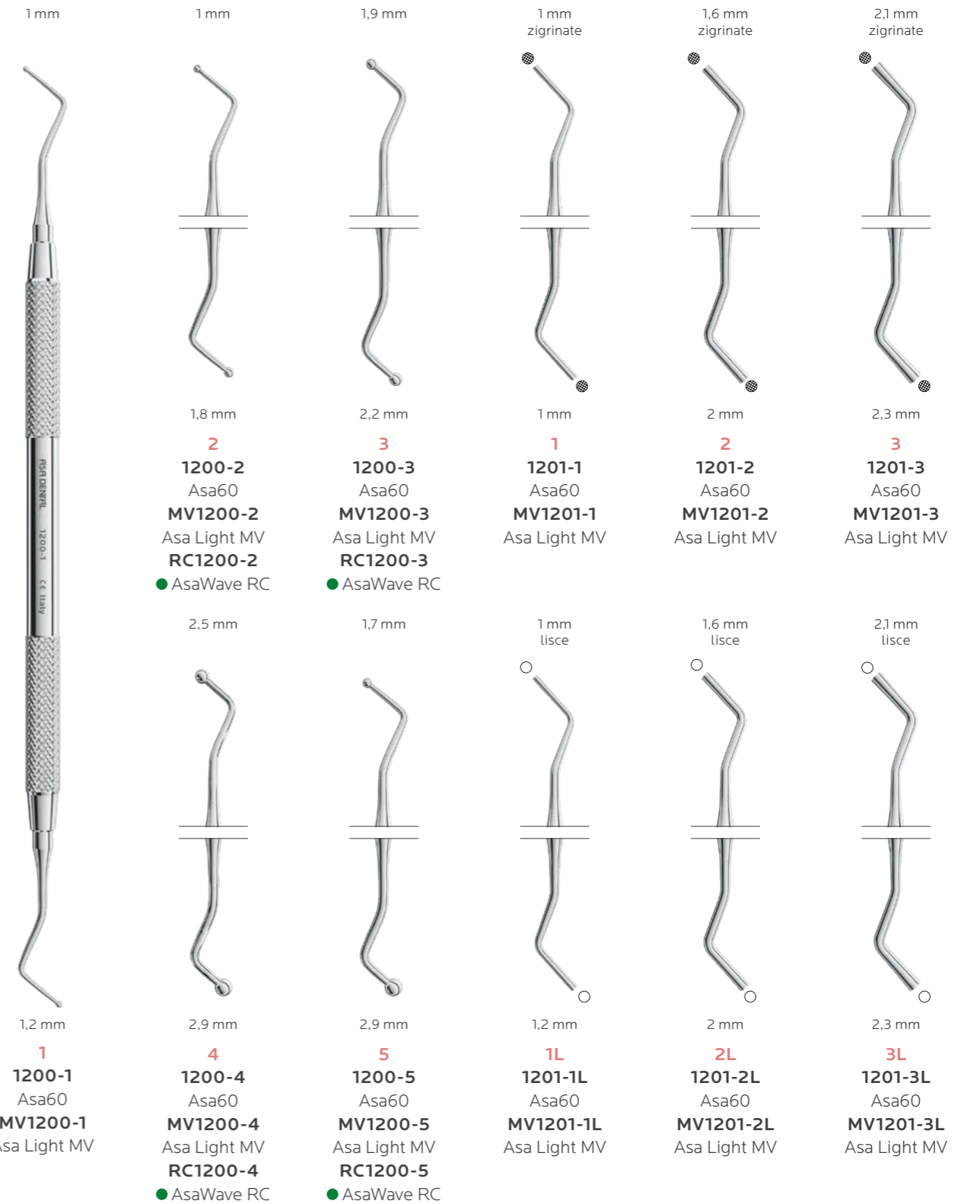

Modello	Codice Set	Manico
1	S1200-1	Asa60
2	S1200-2	Asa60
3	S1200-3	Asa60
4	S1200-4	Asa60
5	S1200-5	Asa60

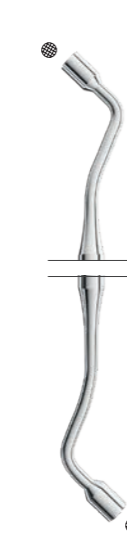
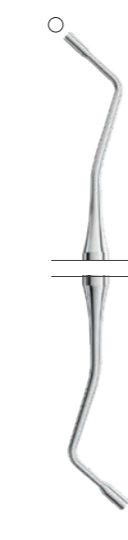

OTTURATORI PER AMALGAMA

<p>1,2 mm zigrinate</p>  <p>1 1202-1 Asa60 MV1202-1 Asa Light MV</p>	<p>1,8 mm zigrinate</p>  <p>2 mm 2 1202-2 Asa60 MV1202-2 Asa Light MV RC1202-2 ● AsaWave RC</p>	<p>2,3 mm zigrinate</p>  <p>2,6 mm 3 1202-3 Asa60 MV1202-3 Asa Light MV</p>	<p>3 mm zigrinate</p>  <p>3,2 mm 4 1202-4 Asa60 MV1202-4 Asa Light MV</p>	<p>1,2 mm lisce</p>  <p>1,4 mm 1L 1202-1L Asa60 MV1202-1L Asa Light MV</p>	<p>1,8 mm lisce</p>  <p>2 mm 2L 1202-2L Asa60 MV1202-2L Asa Light MV</p>
<p>2,3 mm lisce</p>  <p>2,6 mm 3L 1202-3L Asa60 MV1202-3L Asa Light MV</p>	<p>3 mm lisce</p>  <p>3,2 mm 4L 1202-4L Asa60 MV1202-4L Asa Light MV</p>	<p>1 mm</p>  <p>1,2 mm 1 1203-1 Asa60 MV1203-1 Asa Light MV</p>	<p>1,4 mm</p>  <p>1,6 mm 2 1203-2 Asa60 MV1203-2 Asa Light MV</p>	<p>1,8 mm</p>  <p>2 mm 3 1203-3 Asa60 MV1203-3 Asa Light MV</p>	

OTTURATORI PER AMALGAMA

<p>1,5 mm</p>  <p>2 mm 1 Ward 1205-1 Asa60 MV1205-1 Asa Light MV</p>	<p>2,4 mm</p>  <p>2,8 mm 2 Ward 1205-2 Asa60 MV1205-2 Asa Light MV</p>	<p>1,4 mm</p>  <p>0,8 mm 0T Tanner 1211-0T Asa60 MV1211-0T Asa Light MV</p>	<p>2,4 mm</p>  <p>1,4 mm 1T Tanner 1211-1T Asa60 MV1211-1T Asa Light MV</p>	<p>1,2 mm</p>  <p>0,8 mm 2T Tanner 1211-2T Asa60 MV1211-2T Asa Light MV</p>	<p>1,8 mm</p>  <p>1,5 mm 3T Tanner 1211-3T Asa60 MV1211-3T Asa Light MV</p>
<p>1 mm zigrinate</p>  <p>1,4 mm 01 Marquette 1212-01 Asa60 MV1212-01 Asa Light MV</p>	<p>1,5 mm</p>  <p>1 mm H1 Hollenback 1213-H1 Asa60 MV1213-H1 Asa Light MV</p>	<p>3 mm</p>  <p>2 mm H2 Hollenback 1213-H2 Asa60 MV1213-H2 Asa Light MV</p>	<p>2,6 mm</p>  <p>1 mm H3 Hollenback 1213-H3 Asa60 MV1213-H3 Asa Light MV</p>	<p>1,8 mm</p>  <p>2,6 mm H4 Hollenback 1213-H4 Asa60 MV1213-H4 Asa Light MV</p>	

OTTURATORI PER AMALGAMA
Markley

Set da 6

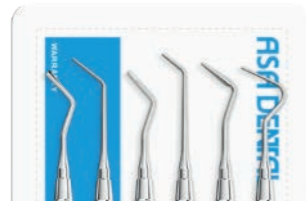

Modello	Codice Set	Manico
1 · 2 · 3 · 4 · 5 · 6	S1400	Asa60
1 · 2 · 3 · 4 · 5 · 6	SMV1400	Asa Light MV

0,4 mm	0,5 mm	0,4 mm	3 mm
0,6 mm	1 mm	1,2 mm	1,6 mm
1 Markley 1400-1 Asa60 MV1400-1 Asa Light MV	2 Markley 1400-2 Asa60 MV1400-2 Asa Light MV	3 Markley 1400-3 Asa60 MV1400-3 Asa Light MV	6 Markley 1400-6 Asa60 MV1400-6 Asa Light MV
	3 mm	1,2 mm	
	1,6 mm	0,5 mm	
	4 Markley 1400-4 Asa60 MV1400-4 Asa Light MV	5 Markley 1400-5 Asa60 MV1400-5 Asa Light MV	

OTTURATORI PER AMALGAMA
Foc

	zigrinate		zigrinate
0 Foc ML1401-0/WML1401-0 Leonardo ML 1401-0 Asa60	0S Foc 1401-0S Asa60 ML1401-0S Leonardo ML	1 Foc 1401-1 Asa60 ML1401-1/WML1401-1 Leonardo ML	2S Foc 1401-2S Asa60 ML1401-2S Leonardo ML
	zigrinate		
1S Foc 1401-1S Asa60 ML1401-1S Leonardo ML	1 Foc 1401-1 Asa60 ML1401-1 Leonardo ML	2 Foc 1401-2 Asa60 ML1401-2 Leonardo ML	





OTTURATORI

Brunitori

2,2 mm	2,8 mm	1,2 mm	1 mm	1,4 mm	2 mm
					
	3,2 mm 2 Westcott 1204-2 Asa60 MV1204-2 Asa Light MV	2 mm 2 Ladmore 1214-2 Asa60 MV1214-2 Asa Light MV	1,8 mm 3 Ladmore 1214-3 Asa60 MV1214-3 Asa Light MV	2,5 mm 18 Ball 1215-18 Asa60 MV1215-18 Asa Light MV RC1215-18 ● AsaWave RC	1 mm 26-27S Ball 1215-27S Asa60 MV1215-27S Asa Light MV RC1215-27S ● AsaWave RC
	1,6 mm		3,4 mm		
					
2,5 mm 1 Westcott 1204-1 Asa60 MV1204-1 Asa Light MV	3 mm 27-29 Ball 1215-29 Asa60 MV1215-29 Asa Light MV	1,3 mm A 1214-A Asa60	W3 1215-W3 Asa60	NYU/B2 1220-B2 Asa60 MV1220-B2 Asa Light MV	2/31 1221-31 Asa60 MV1221-31 Asa Light MV

STRUMENTI PER OTTURAZIONI PLASTICHE





con punte rivestite al nitruro di titanio

1 mm	1,6 mm	2 mm	2 mm	2,9 mm
				
1,2 mm 1 1208T-1 Asa60	2 mm 2 1208T-2 Asa60	2,6 mm 3 1208T-3 Asa60	0,1 mm 2 1209T-2 Asa60	0,4 mm 2 1210T-2 Asa60

STRUMENTI PER OTTURAZIONI PLASTICHE

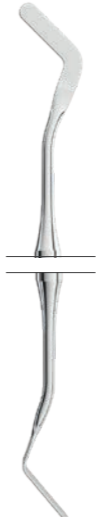
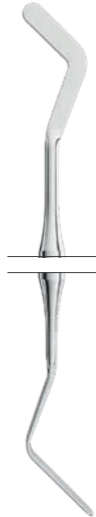
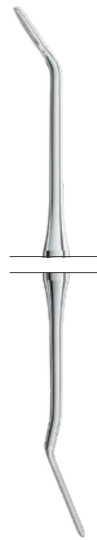
1,2 mm	1,6 mm	1,2 mm	1,6 mm	1 mm	2,5 mm
					
	0,1 mm	2,2 mm	2,7 mm	2 mm	
	2 1206-2 Asa60 MV1206-2 Asa Light MV	1 1207-1 Asa60 MV1207-1 Asa Light MV	2 1207-2 Asa60 MV1207-2 Asa Light MV	1 1208-1 Asa60 MV1208-1 Asa Light MV	
	0,7 mm	2,5 mm	1 mm	2 mm	
					
0,1 mm	2,5 mm	3 mm	0,1 mm	0,1 mm	0,1 mm
1 1206-1 Asa60 MV1206-1 Asa Light MV	2 1208-2 Asa60 MV1208-2 Asa Light MV	3 1208-3 Asa60 MV1208-3 Asa Light MV	1 1209-1 Asa60 MV1209-1 Asa Light MV	2 1209-2 Asa60 MV1209-2 Asa Light MV	3 1209-3 Asa60 MV1209-3 Asa Light MV

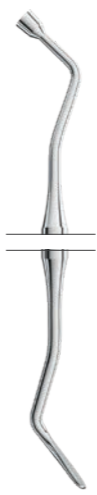
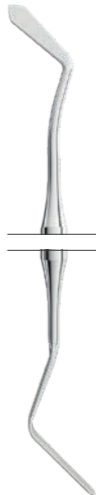
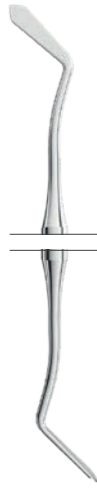
STRUMENTI PER OTTURAZIONI PLASTICHE

				
	2 1210-2 Asa60 MV1210-2 Asa Light MV RC1210-2 ● AsaWave RC	3 1210-3 Asa60 MV1210-3 Asa Light MV RC1210-3 ● AsaWave RC	1 Woodson 1216-1 Asa60 MV1216-1 Asa Light MV	2 Woodson 1216-2 Asa60 MV1216-2 Asa Light MV
				
1 1210-1 Asa60 MV1210-1 Asa Light MV RC1210-1 ● AsaWave RC	3 Woodson 1216-3 Asa60 MV1216-3 Asa Light MV	11 1217-11 Asa60 MV1217-11 Asa Light MV	6 1218-6 Asa60 MV1218-6 Asa Light MV	179 1219-179 Asa60 MV1219-179 Asa Light MV

STRUMENTI PER MODELLARE

STRUMENTI PER MODELLARE



1/2 Hollenback
1500-02
Asa60
MV1500-02
Asa Light MV

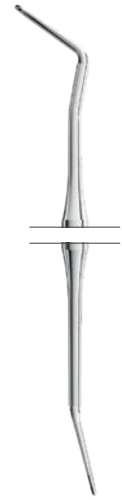

1 Ward
1501-1
Asa60
MV1501-1
Asa Light MV

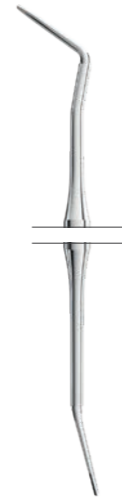

1S Ward
1501-1S
Asa60
MV1501-1S
Asa Light MV



3S Hollenback
1500-3
Asa60
MV1500-3S
Asa Light MV

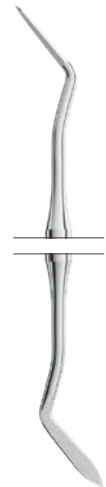

2 Ward
1501-2
Asa60
MV1501-2
Asa Light MV

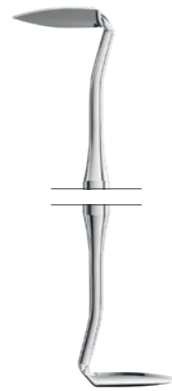

3 Hollenback
1500-3
Asa60
MV1500-3
Asa Light MV



1 Frahm
1502-1
Asa60
MV1502-1
Asa Light MV

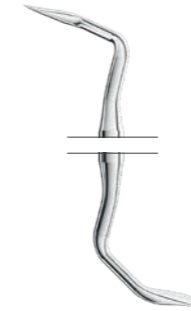

2 USC
1503-2
Asa60

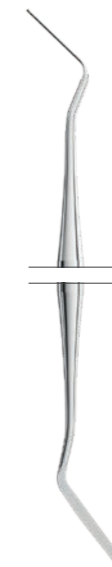

1 Interproximal
1504-1
Asa60

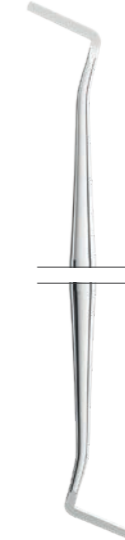

2 Interproximal off-angle
1504-2
Asa60



SHO-A
1505-A
Asa60

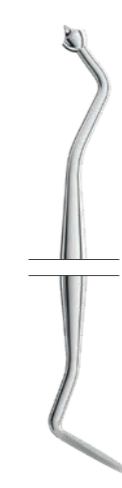

3-SHO
1505-3
Asa60



104
1506-104
Asa60



8 Wiland
1507-8
Asa60
MV1507-8
Asa Light MV

STRUMENTI PER MODELLARE

Strumenti per filo retrattore



- 1**
cleoide-
discoide
1600-1
Asa60
MV1600-1
Asa Light MV
- 2**
cleoide-
discoide
1600-2
Asa60
MV1600-2
Asa Light MV
- 3**
cleoide-
discoide
1600-3
Asa60
MV1600-3
Asa Light MV
- 4**
cleoide-
discoide
1600-4
Asa60
MV1600-4
Asa Light MV



- 1**
1310-1
Asa60
- 2**
1310-2
Asa60

STRUMENTI OPERATIVI

Strumento per
l'applicazione
di tinture e
medicamenti



- Orban Loop**
1303
Ottagonale

Applicatori per sottofondo



- 1300**
Asa35
- 1301**
Asa60
MV1301
Asa Light MV
- 1302**
Asa60
MV1302
Asa Light MV

Porta tamponi

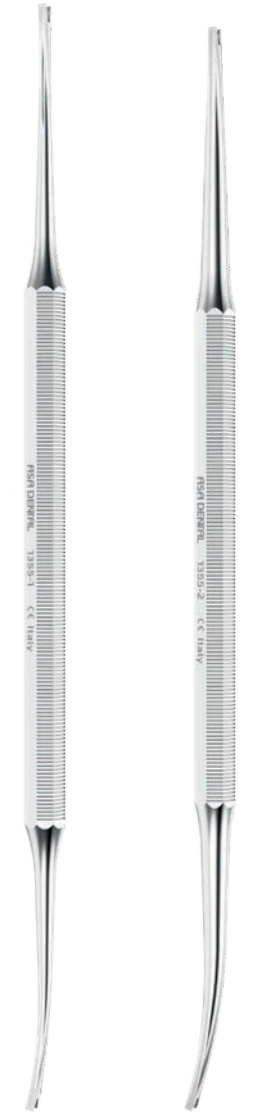

- 1**
Luniatschek
2 mm
1355-1
Ottagonale
- 2**
Luniatschek
3 mm
1355-2
Ottagonale

STRUMENTI PER CORONE
Martelletti levacorone
 con punte doppia attacco

Martelletto levacorone
 con punta singola attacco

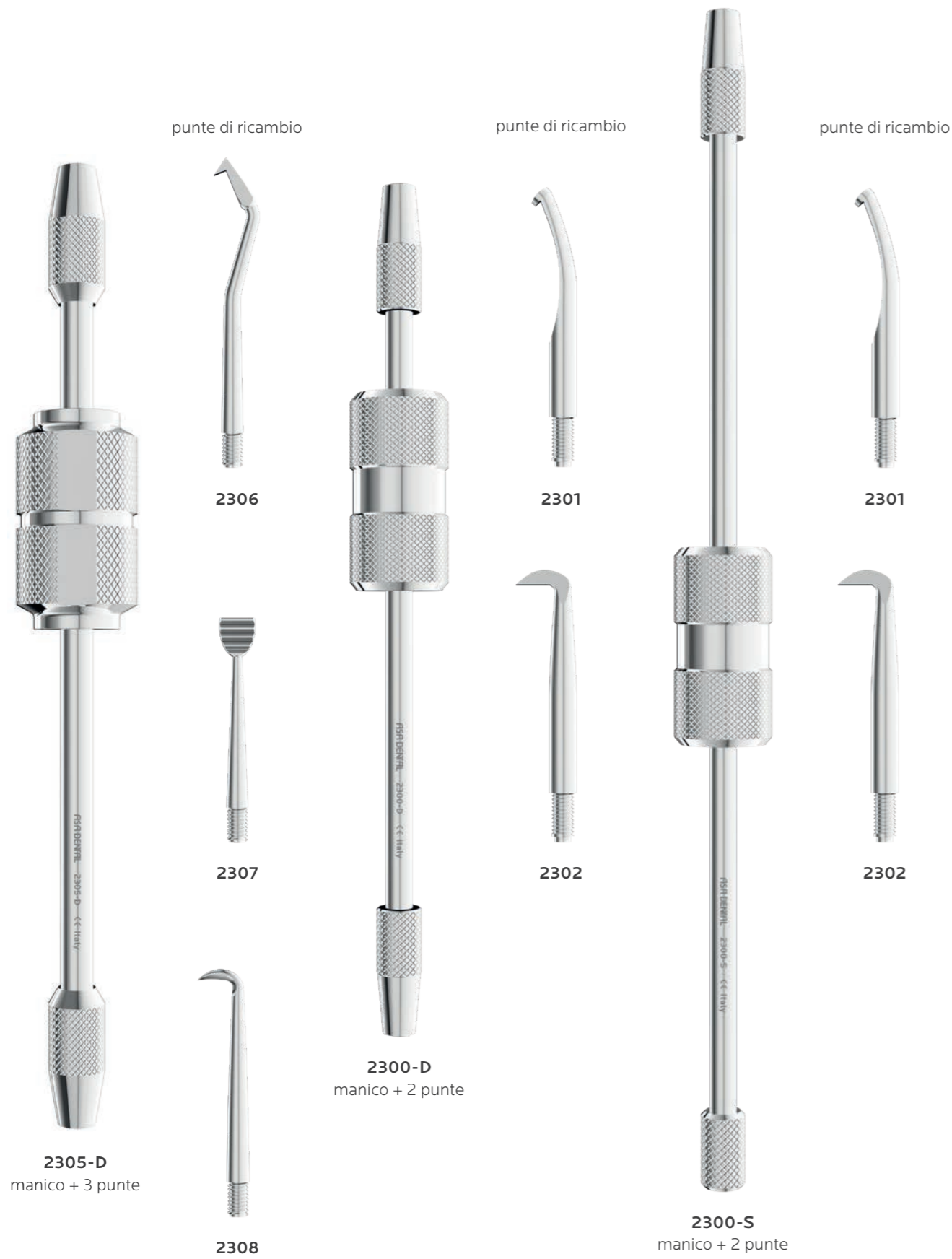

STRUMENTI PER CORONE
Strumenti levacorone e apricorone



STRUMENTI PER CORONE
Calibri decimali

Pinzette per carta da articolazione

STRUMENTI PER CORONE
Pinze telescopiche per corone

Pinze per togliere anelli di rame

scala di misurazione: 0-10 mm
(misure indicative)



**Iwanson
per cera
2550-1**

scala di misurazione: 0-100 mm
(misure indicative)

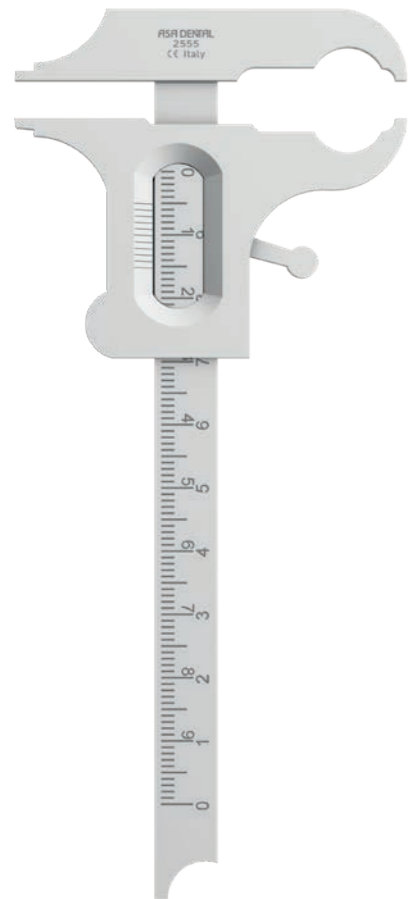

**Boley
14 cm
2555**

scala di misurazione: 0-10 mm
(misure indicative)



**Iwanson
per metallo
2550-2**



**Miller
15 cm
0670**

**15 cm
0671**

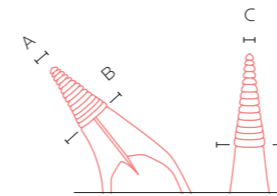

A	4,4 mm
B	5,0 mm
C	3,4 mm
D	3,8 mm



**Böhm
14,5 cm
2500-2**

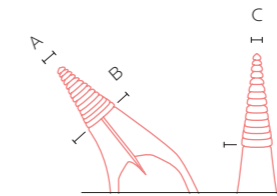

A	3,3 mm
B	4,0 mm
C	2,3 mm
D	3,0 mm



**Böhm
11,5 cm
2500-1**



**Furrer
retta
16 cm
2331-1**



**Furrer
curva
16 cm
2331-2**

PINZE EMOSTATICHE

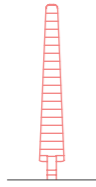

1 Halstead-Mosquito
retta
12 cm
0500-1

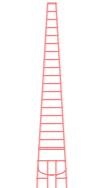

1 Micro-Mosquito
retta
10 cm
0501-1

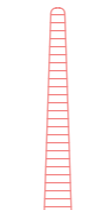

1 Kelly
retta
14 cm
0510-1

FORBICINE
per fogli d'oro



1
retta
12 cm
0300-1

FORBICINE UNIVERSALI
con lame al carburo di tungsteno

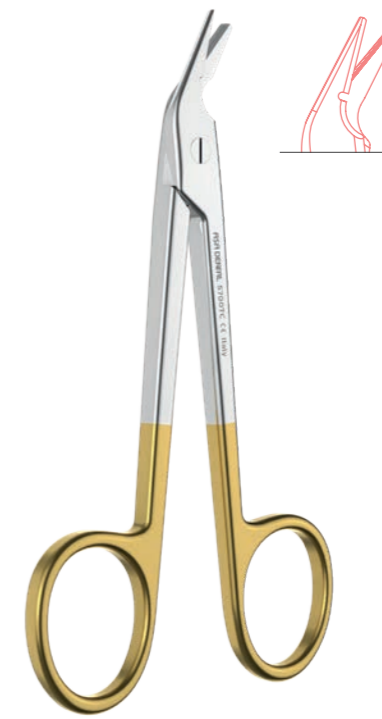

TC Universale
12 cm
5700TC

FORBICINE UNIVERSALI
una lama dentellata



Universale
12 cm
5700

FORBICINE PER CORONE



1
retta
una lama dentellata
10,5 cm
5600-1



2
curva
una lama dentellata
10,5 cm
5600-2

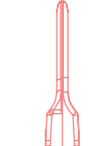

1
retta
10,5 cm
5601-1

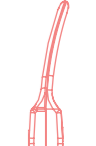

2
curva
10,5 cm
5601-2

PORTA MATRICI

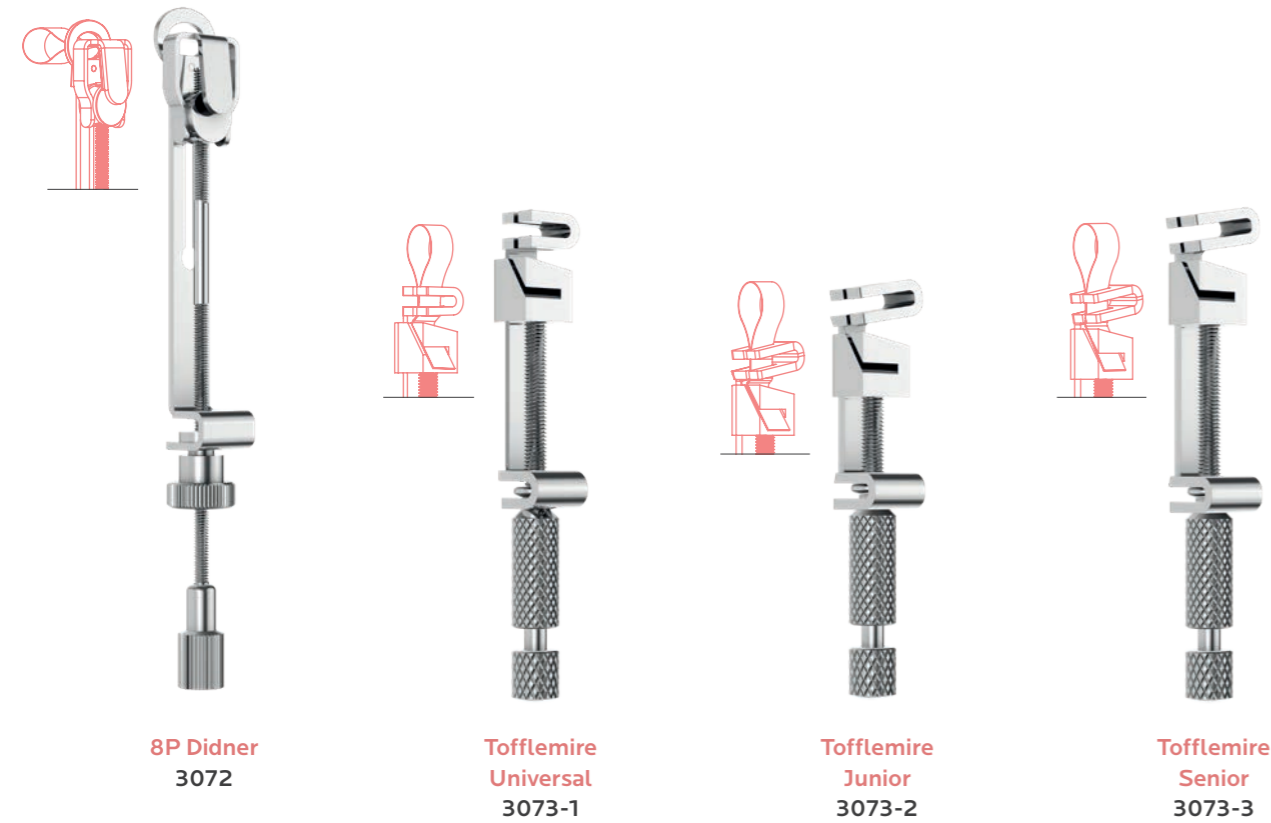
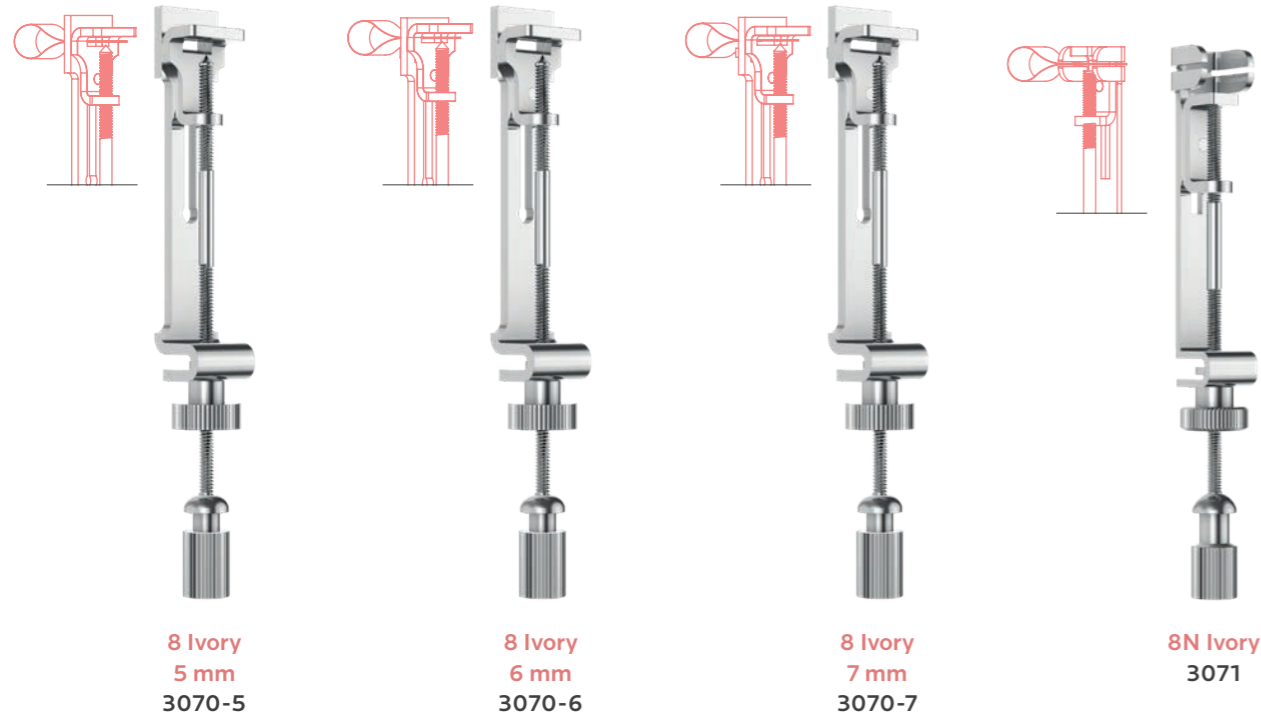

MATRICI
a nastro

per porta matrici

- 3070-5
- 3071
- 3072
- 3073-1
- 3073-2
- 3073-3

per porta matrici

- 3070-6
- 3070-7
- 3071
- 3072
- 3073-1
- 3073-2
- 3073-3

per porta matrici

- 3070-7
- 3071
- 3072
- 3073-1
- 3073-2
- 3073-3



5 mm x 100 cm
3082-5



6 mm x 100 cm
3082-6



7 mm x 100 cm
3082-7

Tofflemire
12 pz / confezione

12 pz / confezione
assortiti:



1
Tofflemire
3081-1



2
Tofflemire
3081-2



3
Tofflemire
3081-3

- 3081-1
- 3081-2
- 3081-3



Tofflemire
3081

STRUMENTI PER COMPOSITO

Molari e Premolari

Molari, Premolari, Incisivi e Canini



Asa Com 1/1B
5112-3
Asa60

Asa Com 2/2B
0704-16D2
Asa60

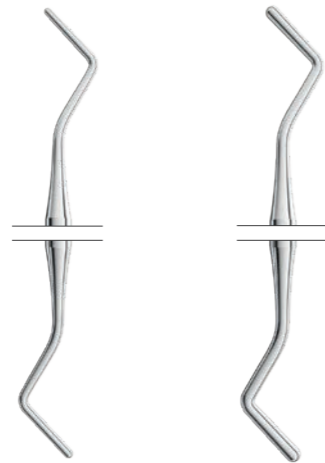

Asa Com 3/3B
1203-1
Asa60

Asa Com 4/4B
1203-3
Asa60

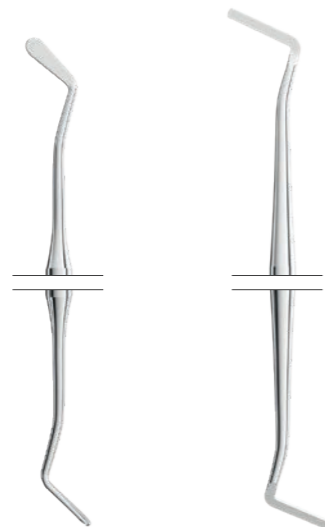

Asa Com 5/5B
1219-179
Asa60

Asa Com 6/6B
1504-2
Asa60

Asa Com 1/1B
due punte della stessa forma ma dimensioni diverse per il riempimento e la modellazione delle facce occlusali di premolari e molari Universale

Asa Com 2/2B
stessa punta ma due angoli diversi per la modellazione dei solchi occlusali di premolari e molari Universale

Asa Com 3/3B
otturatore versatile con punte semisferiche di due diverse dimensioni, ideale per posizionamento e definizione del composito valido per: classe 1, 2, 3, 4 e 5

Asa Com 4/4B
otturatore versatile con punte semisferiche di due diverse dimensioni, ideale per posizionamento e definizione del composito valido per: classe 1, 2, 3, 4 e 5

Asa Com 5/5B
strumento versatile per l'applicazione, la stratificazione e la modellazione del composito, dotato di punte opposte ad angolazione frontale e laterale valido per: classe 1, 2, 3, 4 e 5

Asa Com 6/6B
strumento ideale per il riempimento e la modellazione in aree mesiali e distali valido per: classe 2, 3 e 5

STRUMENTI PER COMPOSITO

Molari, Premolari, Incisivi e Canini

Molari e Premolari



Asa Com 7/7B
5153-1
● Alu80

Asa Com 8/8B
1220-B2
Asa60

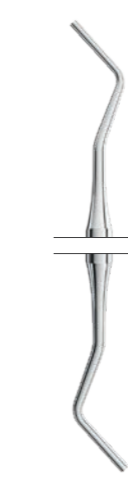

Asa Com 9/9B
1201-1L
Asa60

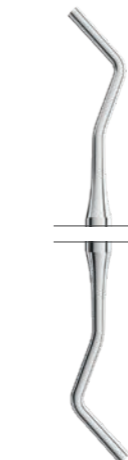

Asa Com 10/10B
1201-2L
Asa60

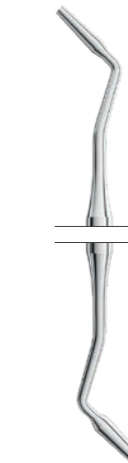

Asa Com 11/11B
1401-1
Asa60

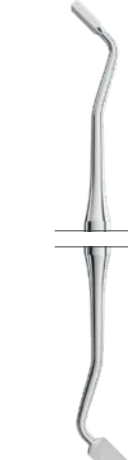

Asa Com 12/12B
1213-H3
Asa60

Asa Com 7/7B
strumento versatile per la definizione nelle zone gengivali ma utilizzabile anche nelle aree mesiali e distali valido per: classe 1, 2, 3, 4 e 5

Asa Com 8/8B
strumento che combina una punta per la modellazione delle aree occlusali e una paletta per le facce labiali Universale

Asa Com 9/9B
otturatore munito di due punte piatte di dimensioni diverse valido per: classe 1, 2, 3, 4 e 5

Asa Com 10/10B
otturatore munito di due punte piatte di dimensioni diverse valido per: classe 1, 2, 3, 4 e 5

Asa Com 11/11B
otturatore a sezione conica, munito di due punte di dimensioni diverse Universale

Asa Com 12/12B
otturatore con punte opposte ad angolazione frontale e laterale Universale

STRUMENTI PER COMPOSITO

Molari, Premolari, Incisivi e Canini



Asa Com 14/14B
1210-1
 Asa60
MV1210-1
 Asa Light MV
RC1210-1
 ● AsaWave RC

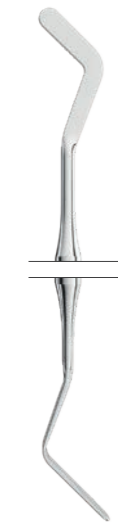

Asa Com 13/13B
 strumento con lame opposte per il taglio, l'asportazione e la modellazione Universale

Asa Com 14/14B
 strumento versatile per l'applicazione, la stratificazione e la modellazione del composito con punte opposte ad angolazione frontale e laterale Universale

Asa Com 15/15B
 strumento versatile per l'applicazione, la stratificazione e la modellazione del composito con punte opposte ad angolazione frontale e laterale valido per: classe 2,3,4 e 5

Asa Com 13/13B
5112-4
 Asa60

Asa Com 15/15B
210-3
 Asa60
MV1210-3
 Asa Light MV
RC1210-3
 ● AsaWave RC

Strumenti per composito AsaWave

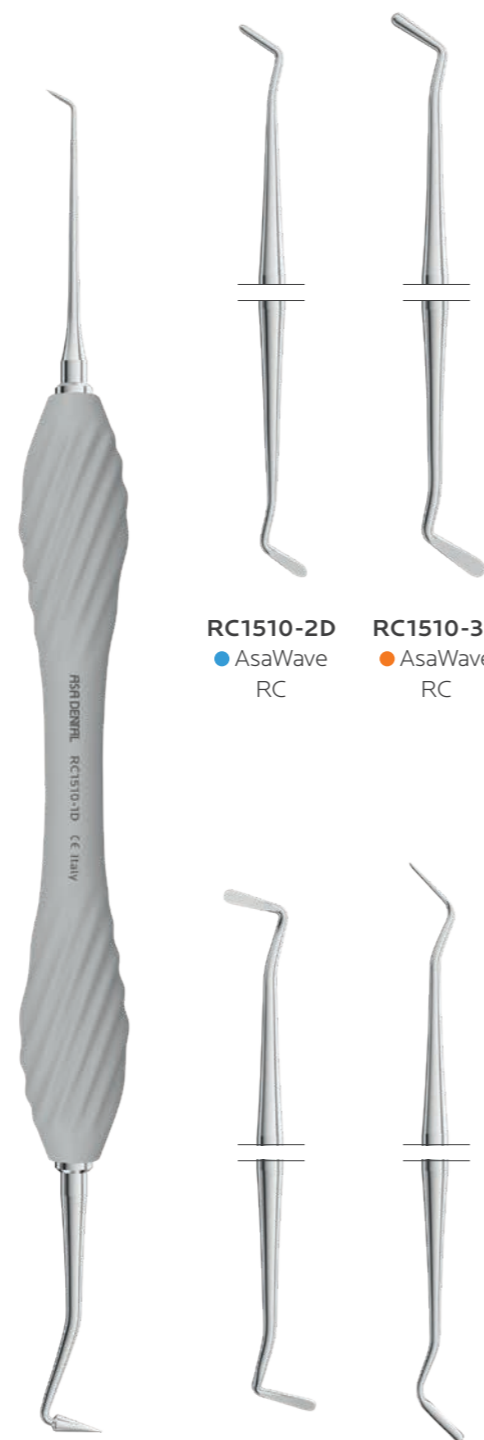

RC1510-2D ● AsaWave RC
RC1510-3D ● AsaWave RC

RC1510-1D ● AsaWave RC
RC1510-4D ● AsaWave RC
RC1510-5D ● AsaWave RC

STRUMENTI PER COMPOSITO



S1222-7

- Asa Com 1/1B 5112-3
- Asa Com 2/2B 0704-16D2
- Asa Com 3/3B 1203-1
- Asa Com 4/4B 1203-3
- Asa Com 5/5B 1219-179
- Asa Com 6/6B 1504-2
- Asa Com 7/7B 5153-1



S1222-15

- Asa Com 1/1B 5112-3
- Asa Com 2/2B 0704-16D2
- Asa Com 3/3B 1203-1
- Asa Com 4/4B 1203-3
- Asa Com 5/5B 1219-179
- Asa Com 6/6B 1504-2
- Asa Com 7/7B 5153-1
- Asa Com 8/8B 1220-B2
- Asa Com 9/9B 1201-1L
- Asa Com 10/10B 1201-2L
- Asa Com 11/11B 1401-1
- Asa Com 12/12B 1213-H3
- Asa Com 13/13B 5112-4
- Asa Com 14/14B 1210-1
- Asa Com 15/15B 1210-3

ENDODONZIA

MADE IN ITALY

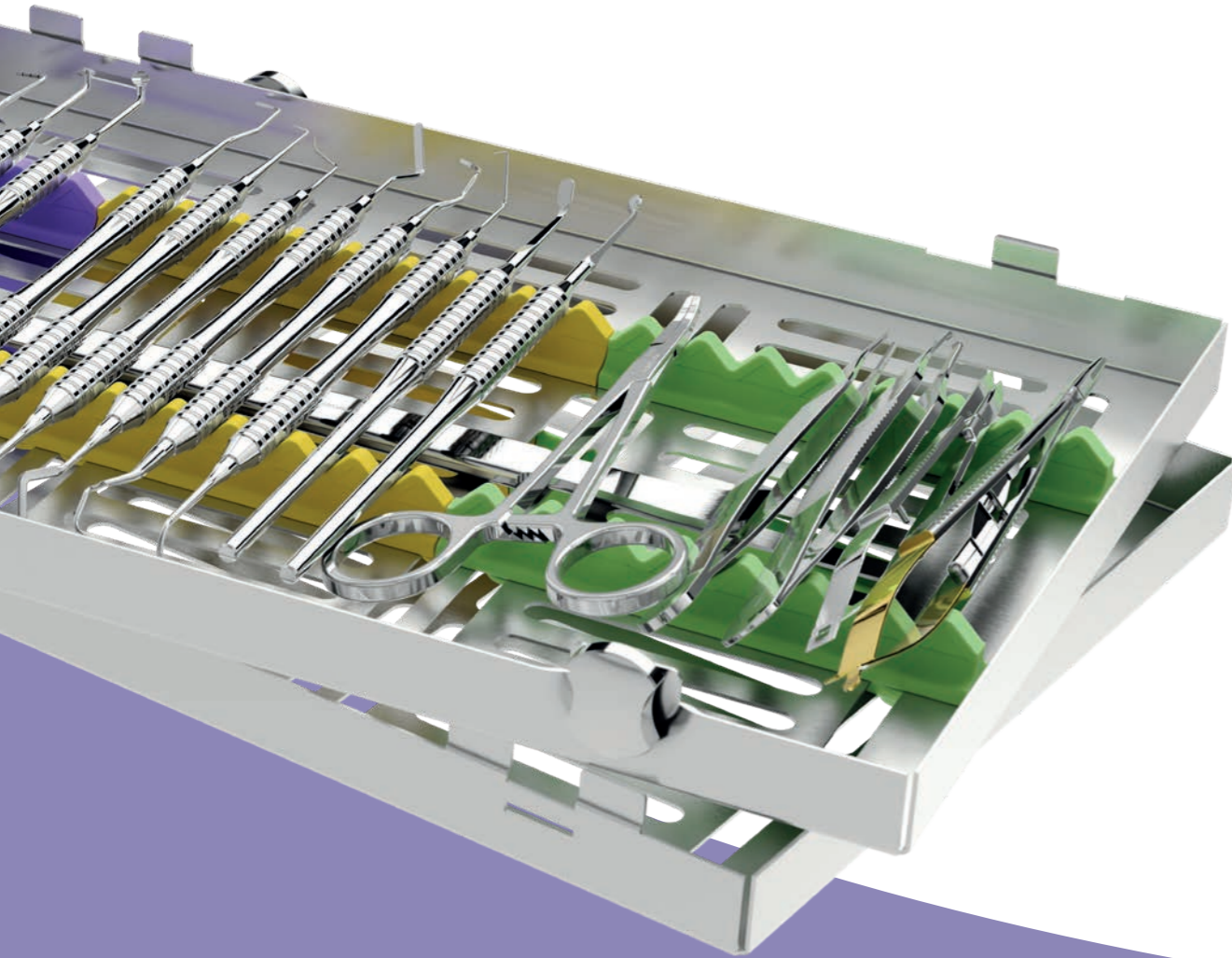

G2	Strumenti Endodontici
G4	Condensatori per trattamenti canalari
G5	Otturatori per canali
G7	Condensatori
G8	Apical Essential
G12	Apical Full

PRECISIONE E SICUREZZA CON STRUMENTI ALL'AVANGUARDIA

L'endodonzia rappresenta una branca essenziale dell'odontoiatria, focalizzata sulla diagnosi, prevenzione e trattamento delle patologie della polpa dentale e dei tessuti periradicolari, con l'obiettivo primario di preservare i denti naturali.

Asa Dental si distingue in questo campo offrendo una gamma completa di strumenti endodontici di alta qualità, progettati per garantire interventi precisi e minimamente invasivi. Tra le nostre innovazioni, spiccano due kit specifici per la microchirurgia endodontica, che equipaggiano i professionisti con strumenti all'avanguardia per affrontare anche i casi clinici più complessi, assicurando risultati ottimali e la massima sicurezza per i pazienti.

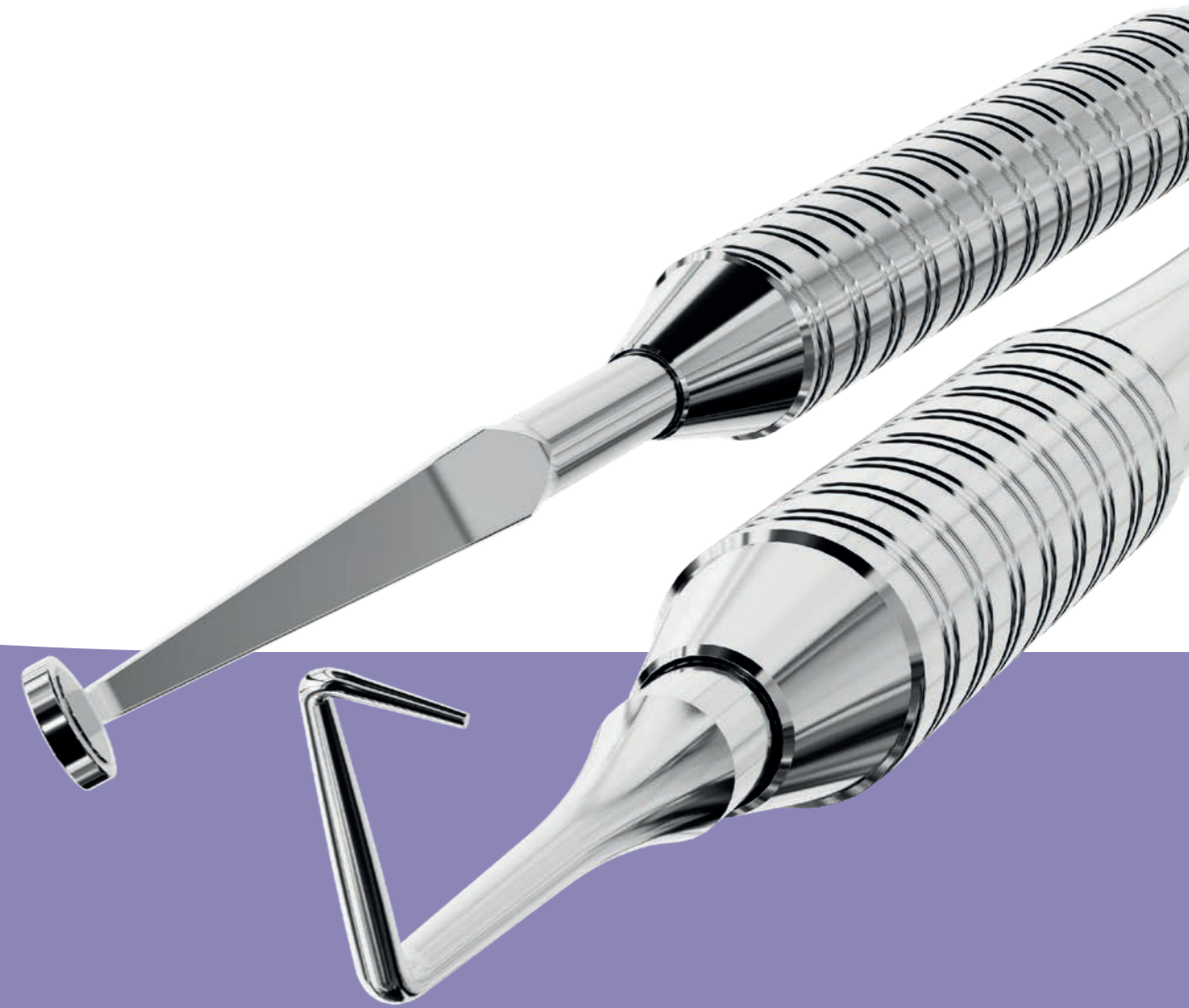

STRUMENTI ENDODONTICI

Pinze per togliere tiranervi rotti



1
13 cm
0870-1



2
13 cm
0870-2

STRUMENTI ENDODONTICI

Pinze e pinzette per coni d'argento



1 Stieglitz
0102-1

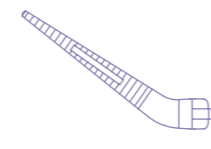

2 Stieglitz
0102-2

CONDENSATORI PER TRATTAMENTI CANALARI

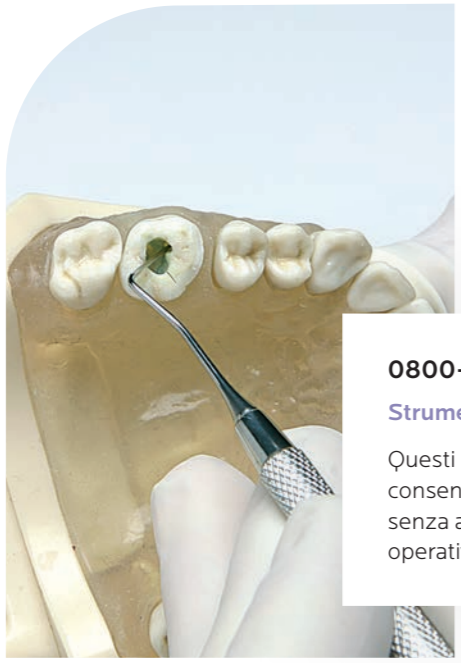
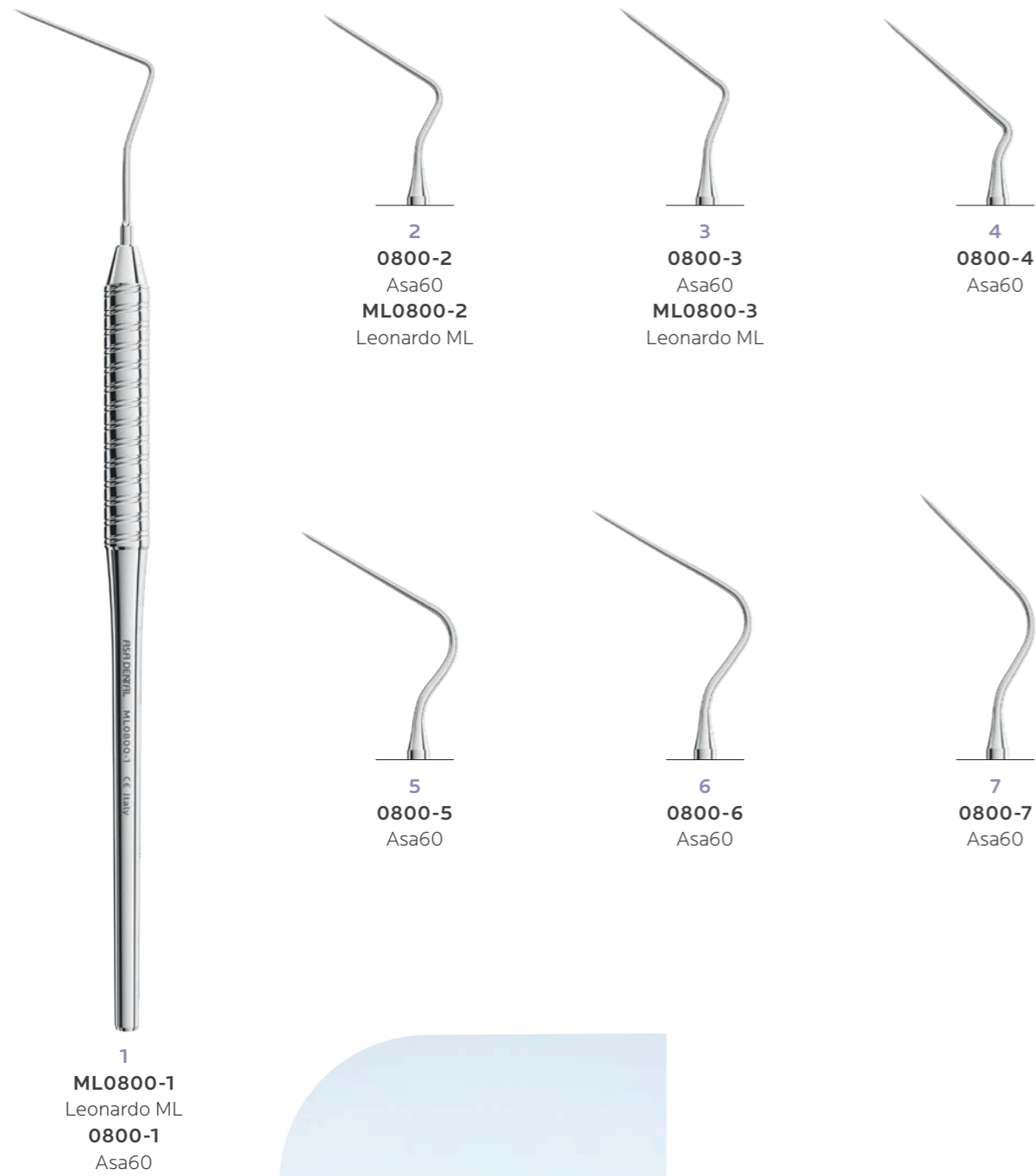

0800-1
Strumenti per trattamenti canalari
Questi strumenti sono dotati di un rivestimento che consente alle punte di svolgere la loro funzione senza alcuna aderenza, qualunque sia la condizione operativa e la pressione applicata.

OTTURATORI PER CANALI

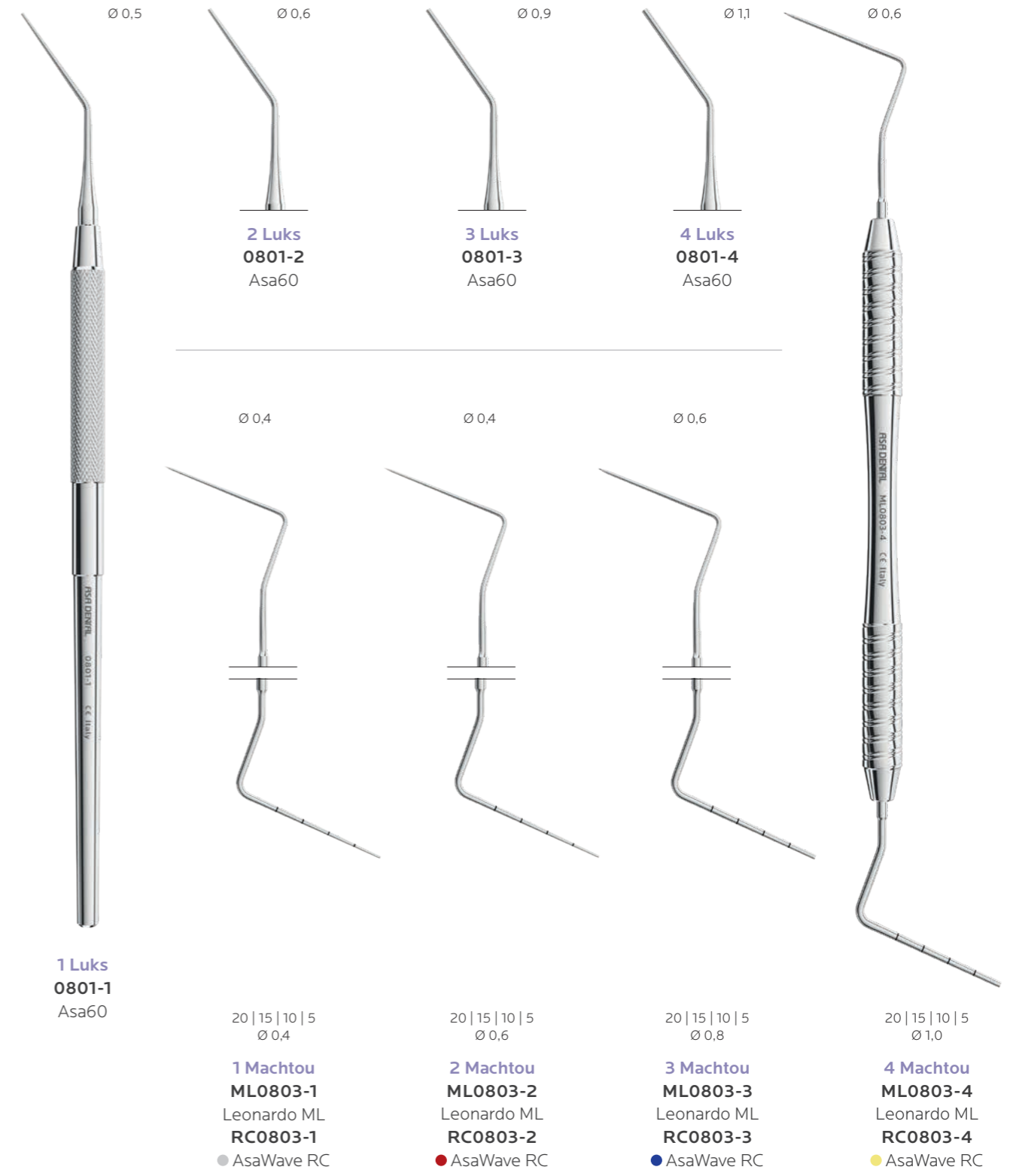

OTTURATORI PER CANALI

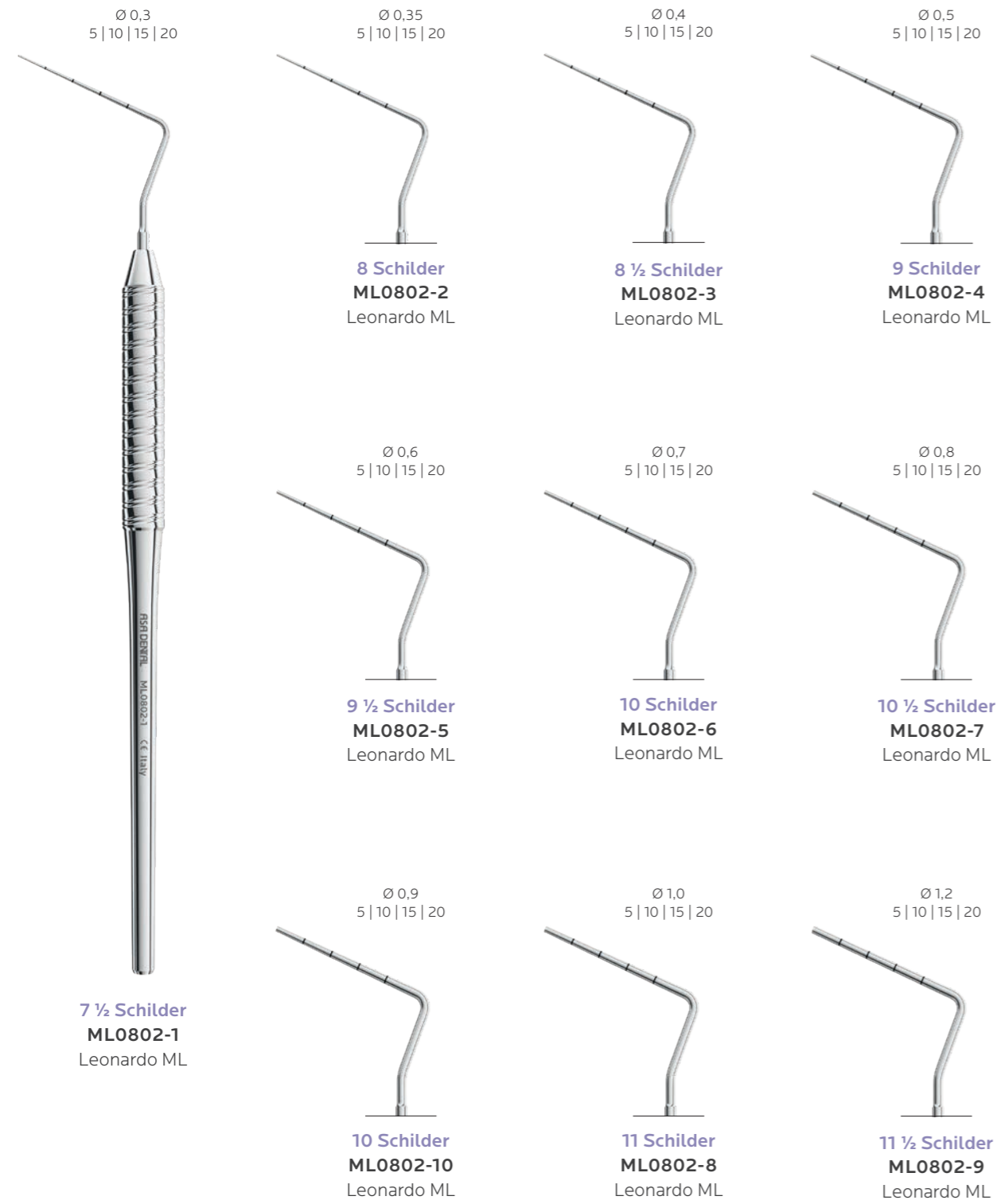

CONDENSATORI

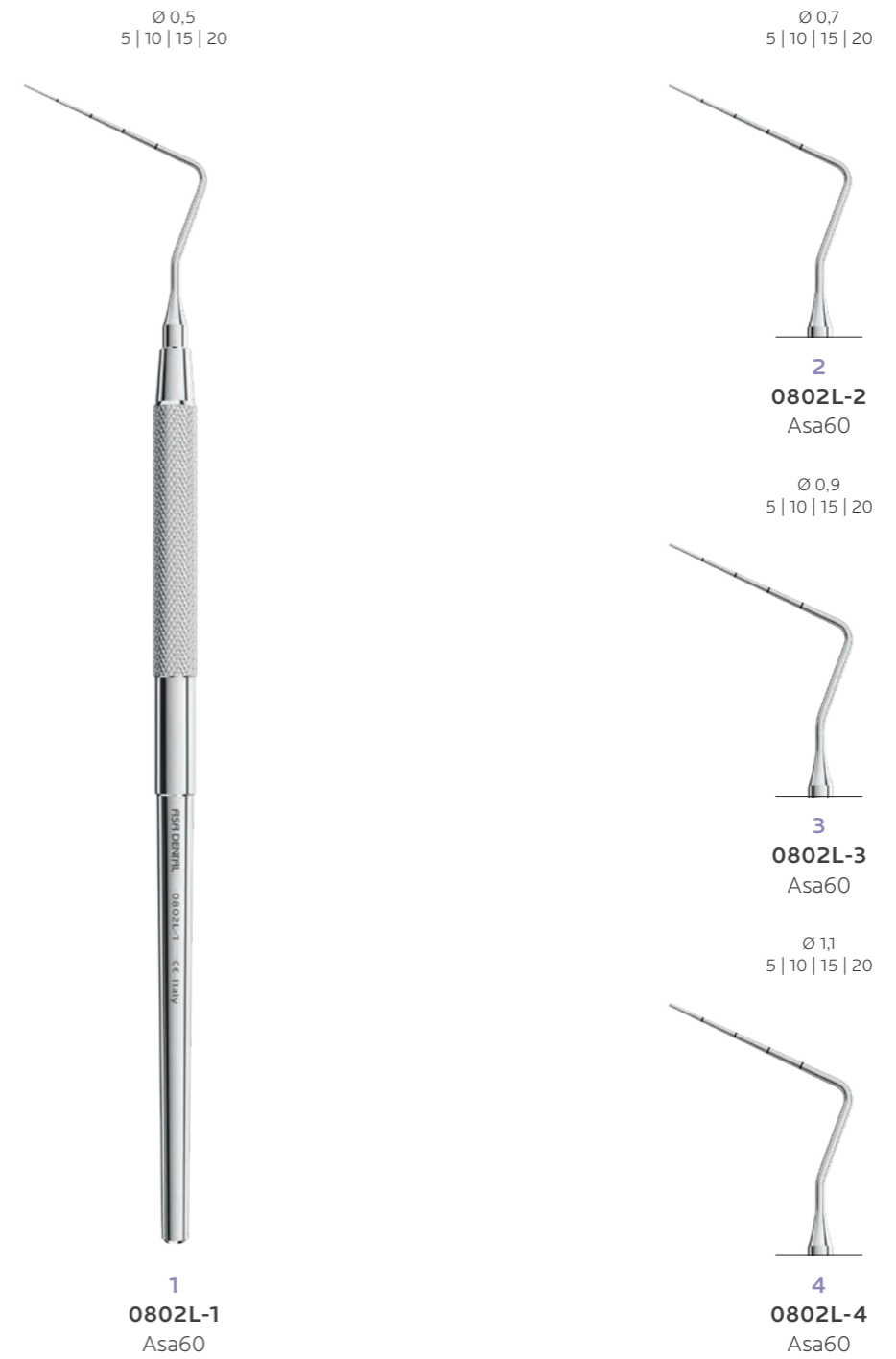

MISURATORE PER STRUMENTI CANALARI

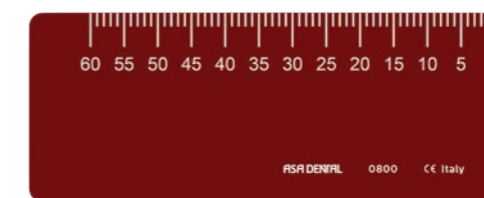

0800

APICAL

Micro Endo Surgery Kits

APICAL ESSENTIAL

Una selezione di strumenti dal design esclusivo di Asa Dental completata da micro specchietti.

SML2021FP	Apical micro endo kit Essential	
ML0805-1	plugger PIR1	1
ML1222-1	plugger PIR2	2
ML1222-2	plugger PIR3	2
ML2017-1	bone curette FAR1	1
ML2017-2	bone curette FAR2	2
2240-1	micro specchietto singolo 3 mm	1
ML2101	manico specchietto	
2771-1L	locking tray per 10 strumenti (lilla)	

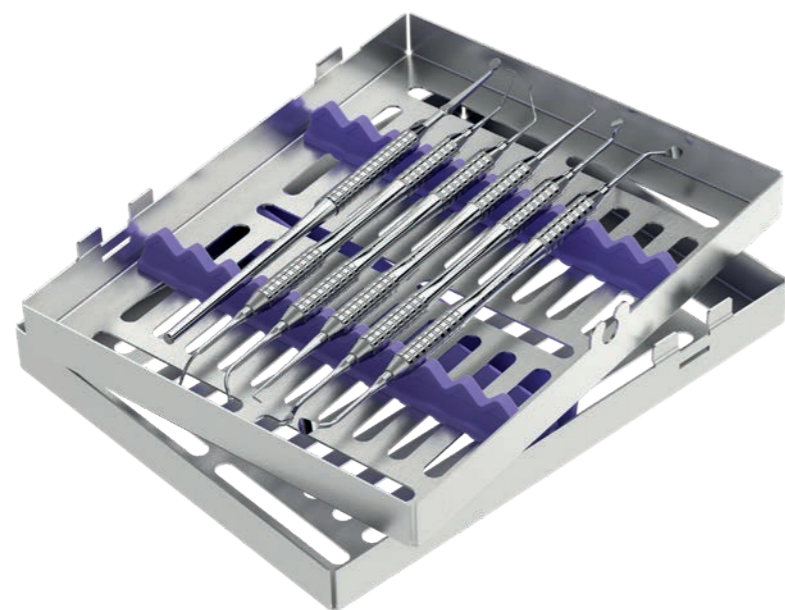

APICAL Essential
SML2021FP

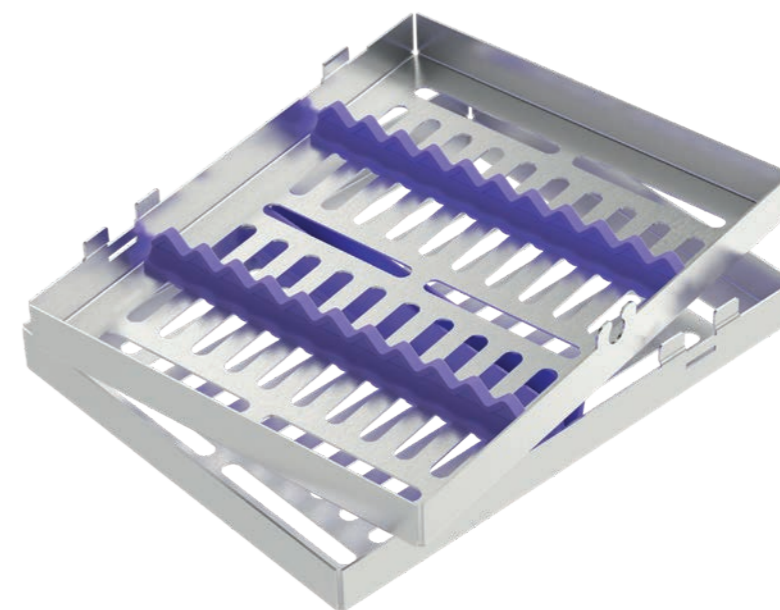

Locking tray per 10 strumenti
(lilla)
2771-1L

APICAL ESSENTIAL

Una selezione di strumenti dal design esclusivo di Asa Dental completata da micro specchietti.



Plugger PIR1
ML0805-1



Plugger PIR2
ML1222-1



Plugger PIR3
ML1222-2



Bone curette FAR1
ML2017-1



Bone curette FAR2
ML2017-2



Micro specchietto singolo 3 mm
2240-1



Manico specchietto
ML2101

APICAL

Micro Endo Surgery Kits

APICAL FULL

Una selezione completa di strumenti per eseguire qualsiasi tipo di micro intervento.

SML2021CF	Apical micro endo kit Full	
ML0805-1	plugger PIR1	1
ML1222-1	plugger PIR2	2
ML1222-2	plugger PIR3	2
ML2017-1	bone curette FAR1	1
ML2017-2	bone curette FAR2	2
ML2101 x2	manico specchietto	
2240-1	micro specchietto singolo 3 mm	1
2241-5	micro specchietto singolo 3x6 mm	5
1855-23	Seldin retractor	23
0365-1	manico per microlame	
0702L-15	sonda millimetrica parodontale	15
ML1807-14	Gracey Fig. 13/14	13/14
ML1807-02	Gracey Fig. 1/2	1/2
0622-1	pinzetta cm. 12 Fig. 1 Micro-adson 1x2	1
0624-1	pinzetta cm. 12 Fig. 1 Micro-adson	
ML1102-1	Heidemann manico anatomico Fig. 1	1
0445TH-14TC	porta aghi cm. 14 Castroviejo TC (retto, punta fine)	
0500-2	pinza Halstead-Mosquito (curva) cm. 12	2
0312-1	forbicine cm. 11 Westcott (punte acute)	1
2770-1MX	locking tray per 20 strumenti (lilla, giallo, verde)	

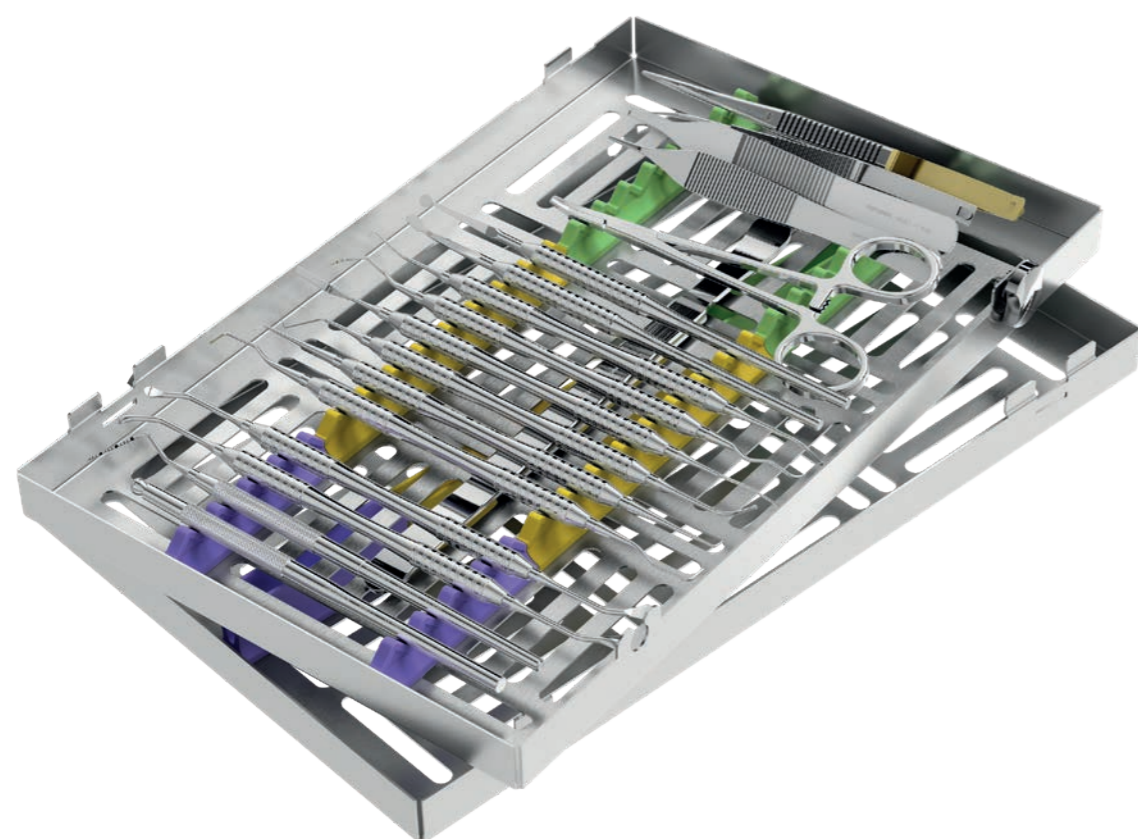

APICAL Full
SML2021CF

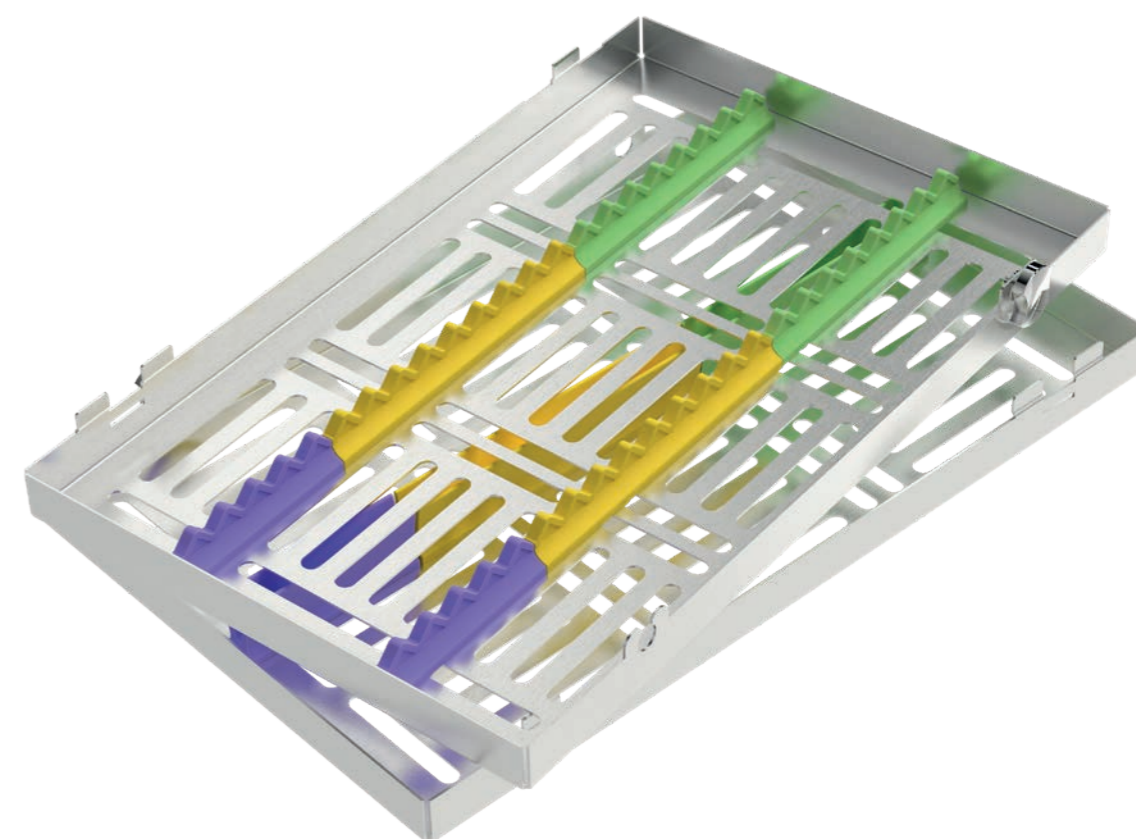

Locking tray per 20 strumenti
(lilla, giallo, verde)
2770-1MX

APICAL FULL

Una selezione completa di strumenti per eseguire qualsiasi tipo di micro intervento.



Plugger PIR1
ML0805-1



Plugger PIR2
ML1222-1



Plugger PIR3
ML1222-2



Bone curette FAR1
ML2017-1



Bone curette FAR2
ML2017-2



Micro specchietto singolo 3 mm
2240-1



Manico specchietto
ML2101

APICAL FULL

Una selezione completa di strumenti per eseguire qualsiasi tipo di micro intervento.



Micro specchietto singolo 3x6 mm
2241-5



Manico specchietto
ML2101



Seldin retractor
1855-23



Manico per microlame
0365-1



Sonda millimetrica parodontale
0702L-15



Gracey Fig. 13/14
ML1807-14



Gracey Fig. 1/2
ML1807-02

APICAL FULL

Una selezione completa di strumenti per eseguire qualsiasi tipo di micro intervento.

APICAL FULL

Una selezione completa di strumenti per eseguire qualsiasi tipo di micro intervento.



Pinzetta cm. 12 Fig. 1 Micro-Adson 1x2
0622-1



Pinzetta cm. 12 Fig. 1 Micro-Adson
0624-1



Heidemann manico anatomico Fig. 1
ML1102-1



Porta aghi cm. 14 Castroviejo TC
(retto, punta fine)
0445TH-14TC



Pinza Halstead-Mosquito cm. 12 (curva)
0500-2



Forbicine cm. 11 Westcott
(punte acute)
0312-1

APICAL FULL

Una selezione completa di strumenti per eseguire qualsiasi tipo di micro intervento.

PARODONTOLOGIA

MADE IN ITALY

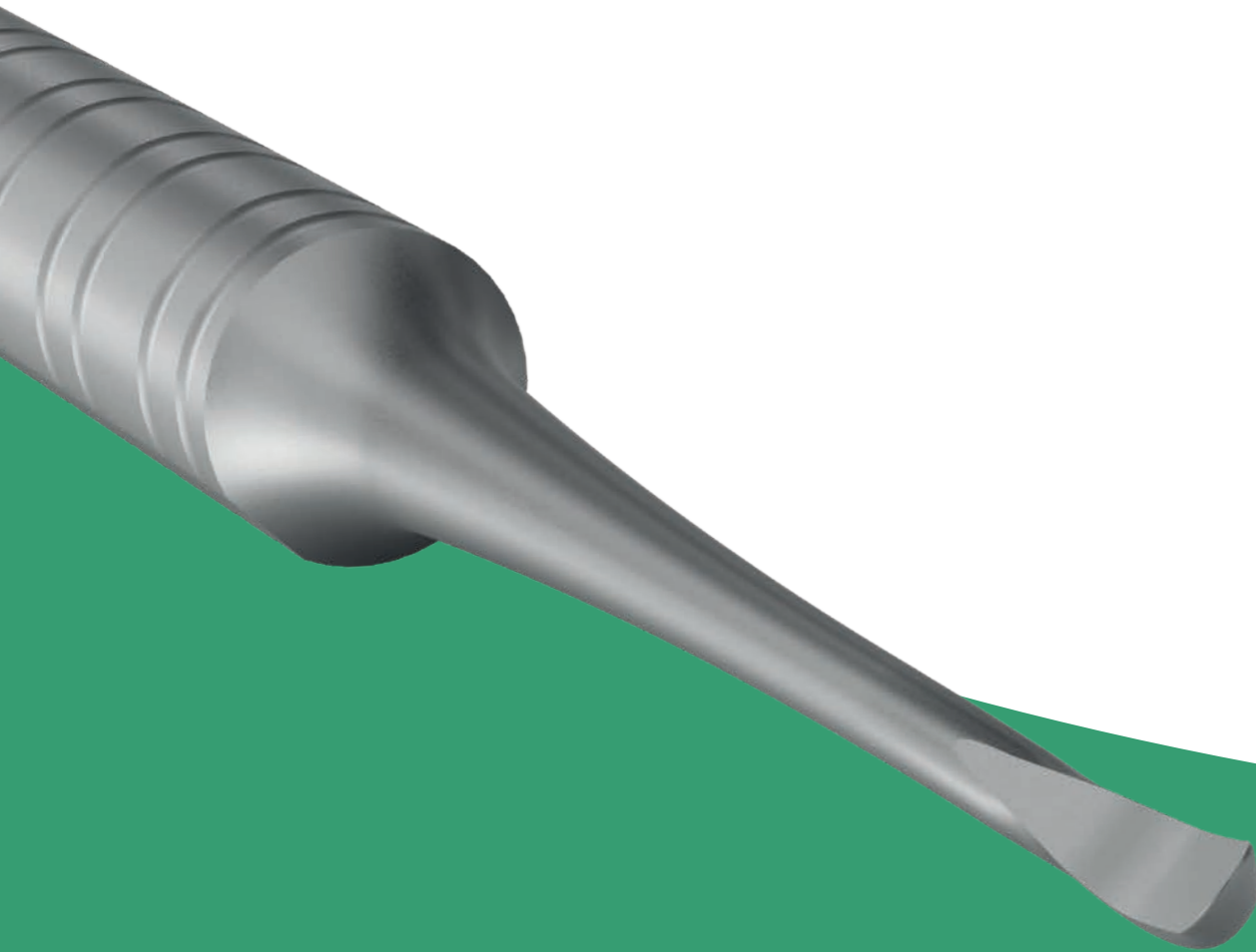

OTTIMIZZARE LE TEMPISTICHE, INCREMENTANDO LA SODDISFAZIONE DEL PAZIENTE

Noi di Asa Dental siamo consapevoli che ogni professionista si pone due obiettivi prioritari tra loro strettamente correlati: la soddisfazione dei propri pazienti e il buon uso del proprio tempo. Per questa ragione, il nostro target principale si è focalizzato sul garantire un'elevata qualità del prodotto nel minor lasso di tempo possibile. Lavoriamo marcando la nostra produzione di innovazione e progresso, vagliando con estrema cura ogni soluzione progettuale in modo da fornire agli specialisti strumenti esclusivi di nuovo ordine sia in termini di forma, che di impugnatura e dimensione.

H3 Sonde millimetriche

H4 Curette e Scaler

H11 Curette Gracey

H14 Scaler

H16 Scollaperiostio ed Elevatori

H20 Cucchiai alveolari

H22 Lime

H24 Bisturi per gengivectomia

H26 Scalpelli e sgorbie

H29 Martelli chirurgici

H30 Strumenti per parodontologia

H31 Pinzette per marcare le tasche

H32 Pietre per affilare

H34 Kit

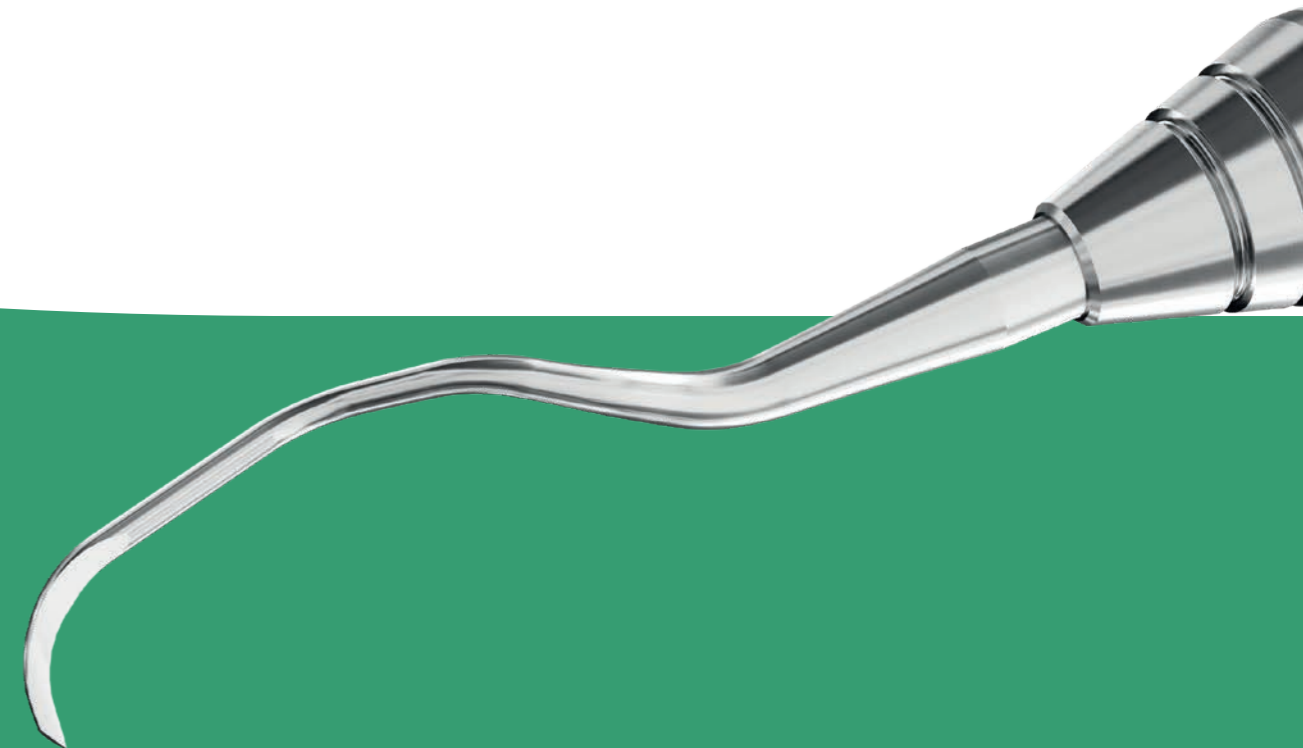

MANICI

PUNTA SINGOLA

- Asa35**
(acciaio inox)
ø 3,5 mm
- Asa60**
(acciaio inox)
ø 6,0 mm
- Leonardo ML**
(acciaio inox)
ø 7,0 mm
- **AsaWave RC**
(resina plastica in PPSU
e anima in acciaio)
ø 7,5 / 14,5 mm



PUNTA DOPPIA

- Asa60**
(acciaio inox)
ø 6,0 mm
- Asa Light MV**
(acciaio inox, vuoto)
ø 8,0 mm
- Leonardo ML**
(acciaio inox)
ø 7,0 mm
- Leonardo Light LV**
(acciaio inox)
ø 10,0 mm
- Ottagonale**
(acciaio inox)
ø 5,5 mm
- Perfection**
(acciaio inox)
ø 8,0 mm
- **AsaWave RC**
(resina plastica in PPSU
e anima in acciaio)
ø 7,5 / 14,5 mm



COME USARE LE INFORMAZIONI

- **CP-12** modello + nome scientifico
- **RC0702-12** codice Asa Dental
- **AsaWave RC** manico

ASA WAVE: IL NUOVO MANICO ASA DENTAL

Massima ergonomia, controllo assoluto. Il nuovo manico in resina di Asa Dental è progettato per offrire un'esperienza senza compromessi. Realizzato in PPSU (Polyphenylsulfone), un materiale ad alte prestazioni, garantisce resistenza eccezionale alla sterilizzazione e agli agenti chimici, preservando la sua integrità nel tempo.

Il design si ispira alle forme della natura con un pattern parametrico avanzato che assicura grip ottimale e precisione nei movimenti, riducendo l'affaticamento della mano. Perfetto equilibrio tra sicurezza e comfort, per strumenti affidabili in ogni procedura.

SONDE MILLIMETRICHE PARODONTALI



Queste sonde parodontali sono facili e veloci da pulire, offrono precisione e durata grazie a incisioni resistenti a condizioni estreme. Il design ergonomico dell'impugnatura le rende un'estensione naturale della tua mano.

- Nuovo processo produttivo
- Sistema di incisione al laser
- Evita pericolose perdite di vernice
- Garantisce una marcatura indelebile
- Le incisioni sono a basso spessore e prive di riflessi
- Il processo mantiene intatta la robustezza delle punte

3 | 6 | 9 | 12



CP-C
0702-C
Asa35

3 | 6 | 8 | 11 3 | 6 | 9 | 12 3,5 | 5,5 | 8,5 | 11,5 1 | 2 | 3 | 4 | 5 | 6 | 7 | 8
9 | 10 | 11 | 12 | 13 | 14 | 15



CP-11
0702L-11
Asa60



CP-12
0702L-12
Asa60

RC0702-12
● AsaWave RC



CP-12S
0702L-12S
Asa60



CP-15
0702L-15
Asa60

1 | 2 | 3 | 5 | 7 | 8 | 9 | 10



Williams
0703L-1
Asa60

1 | 2 | 3 | 5 | 7 | 8 | 9 | 10



Merrit A
0703L-2
Asa60

1 | 2 | 3 | 5 | 7 | 8 | 9 | 10



Merrit B
0703L-3
Asa60

1 | 2 | 3 | 5 | 7 | 8 | 9 | 10
PUNTA PIATTA



Goldman-Fox
0703L-4
Asa60

3 | 6 | 8



University of Michigan
0703L-5
Asa60

1 | 2 | 3 | 5 | 7 | 8 | 9 | 10



26 G
0703L-6
Asa60

3,5 | 6 | 9 | 12



OMS Novatech
ML0702-OMS
Leonardo ML

1 | 2 | 3 | 5 | 7 | 8 | 9 | 10
| 12 | 14



Williams
ML0703-14
Leonardo ML
RC0703-14
● AsaWave RC

CURETTE E SCALER

Set da 7



Modello	Codice Set	Manico
02 · 2RL · 4RL · 14 · 412 · 414 · Z	S1806	Asa60
02 · 2RL · 4RL · 14 · 412 · 414 · Z	SMV1806	Asa Light MV

HU 1/2
1806-02
Asa60
MV1806-02
Asa Light MV

2R/2L Columbia
1806-2RL
Asa60
MV1806-2RL
Asa Light MV
ML1806-2RL
Leonardo ML

4R/4L Columbia
1806-4RL
Asa60
MV1806-4RL
Asa Light MV
ML1806-4RL
Leonardo ML

13/14 Columbia
1806-14
Asa60
MV1806-14
Asa Light MV
ML1806-14
Leonardo ML
RC1806-14/
RC1806-14SF
● AsaWave RC

Zerfing-Chisel
1820-Z
Asa60

411/412 Columbia
1806-412
Asa60
MV1806-412
Asa Light MV

413/414 Columbia
1806-414
Asa60
MV1806-414
Asa Light MV

CURETTE E SCALER

HU 1/2 Langer
1805-02
Asa60
MV1805-02
Asa Light MV

3/4 Langer
1805-04
Asa60
MV1805-04
Asa Light MV

1 De Marco
1808-1
Asa60

2 De Marco
1808-2
Asa60

1/2 Barnhart
1821-02
Asa60

5/6 Barnhart
1821-06
Asa60

13/14 Indiana University anterior
1824-14
Asa60
MV1824-14
Asa Light MV

17/18 Indiana University posterior
1824-18
Asa60
MV1824-18
Asa Light MV

ME-1 (10/11)
1822-ME1
Asa60

3/4 Rule (23/24)
1823-R04
Asa60

CURETTE E SCALER

Set da 7



Modello	Codice Set	Manico
1 · 2 · 3 · 4 · 5 · 6 · 21	S1809	Asa60
1 · 2 · 3 · 4 · 5 · 6 · 21	SMV1809	Asa Light MV



1 Goldman-Fox
1809-1
Asa60
MV1809-1
Asa Light MV
ML1809-1
Leonardo ML

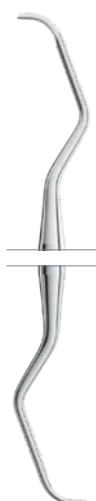

2 Goldman-Fox
1809-2
Asa60
MV1809-2
Asa Light MV
ML1809-2
Leonardo ML



3 Goldman-Fox
1809-3
Asa60
MV1809-3
Asa Light MV
ML1809-3
Leonardo ML



4 Goldman-Fox
1809-4
Asa60
MV1809-4
Asa Light MV
ML1809-4
Leonardo ML

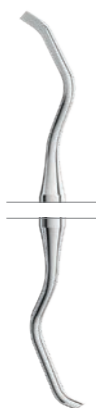

5 Goldman-Fox
1809-5
Asa60
MV1809-5
Asa Light MV
ML1809-5
Leonardo ML



6 Goldman-Fox
1809-6
Asa60
MV1809-6
Asa Light MV

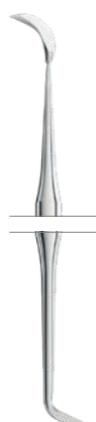

21 Goldman-Fox
1809-21
Asa60
MV1809-21
Asa Light MV
ML1809-21
Leonardo ML

CURETTE E SCALER



11/12 Mc Call
1825-12
Asa60
MV1825-12
Asa Light MV



11A/12A Mc Call
1825-12A
Asa60



13/14 Mc Call
1825-14
Asa60
MV1825-14
Asa Light MV
RC1825-14/
RC1825-14SF
● AsaWave RC

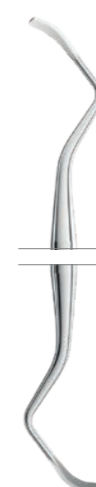

13S/14S Mc Call
1825-14S
Asa60
MV1825-14S
Asa Light MV
ML1825-14S
Leonardo ML
RC1825-14S/
RC1825-14SSF
● AsaWave RC



17S/18S Mc Call
1825-18S
Asa60
MV1825-18S
Asa Light MV



19/20 Mc Call
1825-20
Asa60
MV1825-20
Asa Light MV

CURETTE E SCALER



6S Mini Crane-Kaplan
RC1829-CK6SSF
 ● AsaWave RC
1829-CK6S
 Asa60
ML1829-CK6S
 Leonardo ML
RC1829-CK6S
 ● AsaWave RC

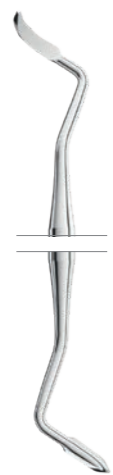

204
1827-204
 Asa60

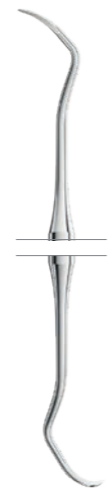

204S
1827-204S
 Asa60
MV1827-204S
 Asa Light MV
ML1827-204S
 Leonardo ML
LV1827-204S
 Leonardo Light LV
RC1827-204S/
RC1827-204SSF
 ● AsaWave RC

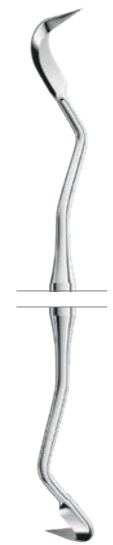

6 Crane-Kaplan
1829-CK6
 Asa60
MV1829-CK6
 Asa Light MV
ML1829-CK6
 Leonardo ML
LV1829-CK6
 Leonardo Light LV
RC1829-CK6/
RC1829-CK6SF
 ● AsaWave RC

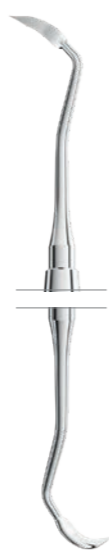

2/3 Taylor
1826-T03
 Asa60
MV1826-T03
 Asa Light MV
ML1826-T03
 Leonardo ML
LV1826-T03
 Leonardo Light LV



7/8 Younger-Good
1830-YG08
 Asa60
MV1830-YG08
 Asa Light MV
ML1830-YG08
 Leonardo ML

CURETTE E SCALER



31/32 Jacquette
1831-32
 Asa60
MV1831-32
 Asa Light MV

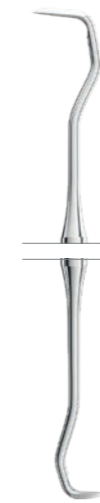

30/33 Jacquette
1831-33
 Asa60
MV1831-33
 Asa Light MV

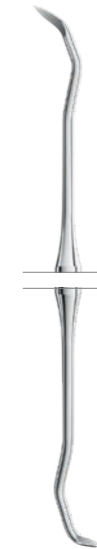

34/35 Jacquette
1831-35
 Asa60
MV1831-35
 Asa Light MV

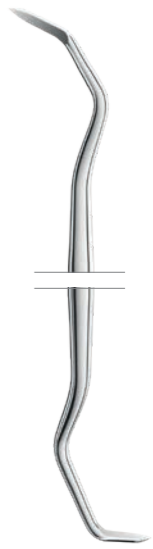

37/38 Jacquette
1831-38
 Asa60
MV1831-38
 Asa Light MV

1831-32



TABELLA DI APPLICAZIONE GRACEY

- Arcate dei denti anteriori
 - GRA 1/2** Incisivi e Canini
 - GRA 3/4** Incisivi e Canini
 - GRA 5/6** Anteriori e Premolari
- Superfici linguali e labiali dei denti posteriori
 - GRA 7/8** Premolari e Molari
 - GRA 9/10** Premolari e Molari
- Superfici mesiali dei denti posteriori
 - GRA 11/12** Premolari e Molari
 - GRA 15/16** Premolari e Molari
- Superfici distali dei denti posteriori
 - GRA 13/14** Molari
 - GRA 17/18** Molari

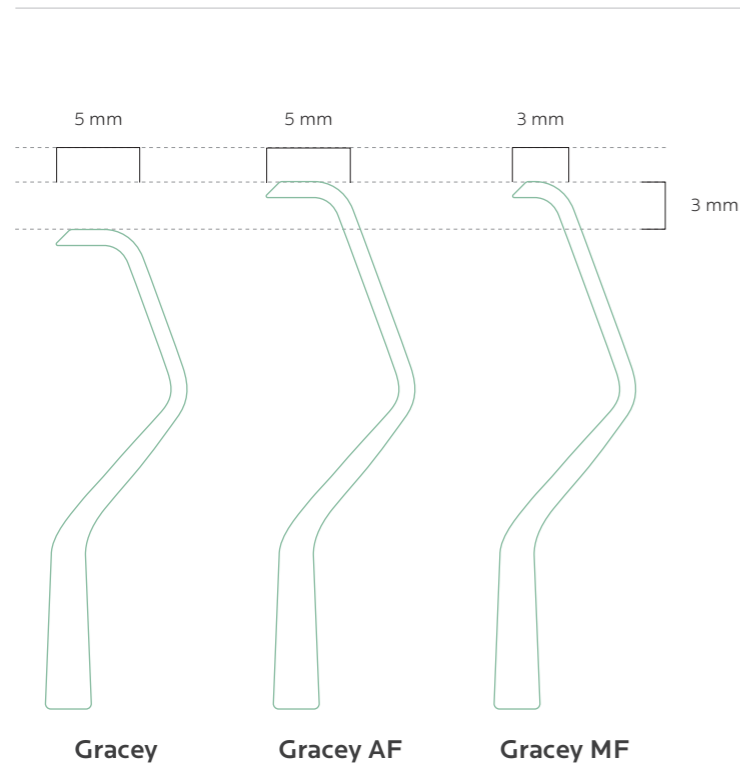
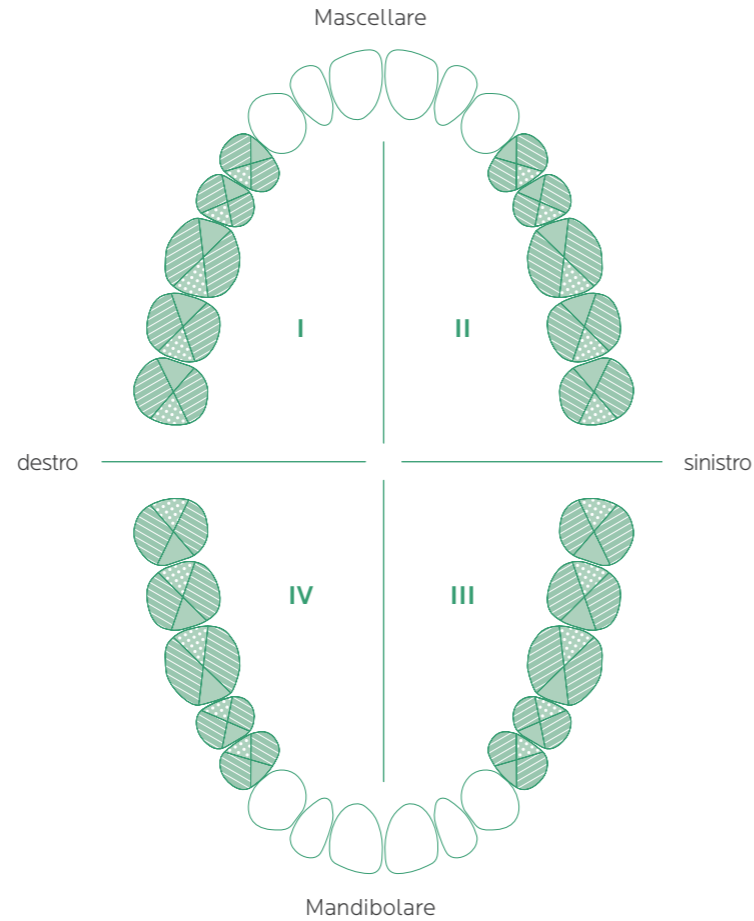

Manici AsaWave

- GRA 1/2
- GRA 3/4
- GRA 5/6
- GRA 7/8
- GRA 9/10
- GRA 11/12
- GRA 13/14
- GRA 15/16
- GRA 17/18

CURETTE GRACEY



	3/4 Gracey 1807-04 Asa60 MV1807-04 Asa Light MV ML1807-04 Leonardo ML LV1807-04/ LV1807-04SF Leonardo Light LV RC1807-04/ RC1807-04SF ● AsaWave RC	5/6 Gracey 1807-06 Asa60 MV1807-06 Asa Light MV ML1807-06 Leonardo ML LV1807-06/ LV1807-06SF Leonardo Light LV RC1807-06/ RC1807-06SF ● AsaWave RCSF	7/8 Gracey 1807-08 Asa60 MV1807-08 Asa Light MV ML1807-08 Leonardo ML LV1807-08/ LV1807-08SF Leonardo Light LV RC1807-08/ RC1807-08SF ● AsaWave RC	9/10 Gracey 1807-10 Asa60 MV1807-10 Asa Light MV ML1807-10 Leonardo ML LV1807-10/ LV1807-10SF Leonardo Light LV RC1807-10/ RC1807-10SF ● AsaWave RC	11/12 Gracey 1807-12 Asa60 MV1807-12 Asa Light MV ML1807-12 Leonardo ML LV1807-12/ LV1807-12SF Leonardo Light LV RC1807-12/ RC1807-12SF ● AsaWave RC
	1/2 Gracey LV1807-02SF Leonardo Light LV 1807-02 Asa60 MV1807-02 Asa Light MV ML1807-02 Leonardo ML LV1807-02 Leonardo Light LV RC1807-02/ RC1807-02SF ● AsaWave RC	13/14 Gracey 1807-14 Asa60 MV1807-14 Asa Light MV ML1807-14 Leonardo ML LV1807-14/ LV1807-14SF Leonardo Light LV RC1807-14/ RC1807-14SF ● AsaWave RC	15/16 Gracey 1807-16 Asa60 ML1807-16 Leonardo ML LV1807-16/ LV1807-16SF Leonardo Light LV RC1807-16/ RC1807-16SF ● AsaWave RC	17/18 Gracey 1807-18 Asa60 ML1807-18 Leonardo ML LV1807-18/ LV1807-18SF Leonardo Light LV RC1807-18/ RC1807-18SF ● AsaWave RC	11/14 Gracey Mesiale-Distale 1807-11MD Asa60 MV1807-11MD Asa Light MV ML1807-11MD Leonardo ML LV1807-11MD Leonardo Light LV
					12/13 Gracey Mesiale-Distale 1807-13MD Asa60 MV1807-13MD Asa Light MV ML1807-13MD Leonardo ML LV1807-13MD Leonardo Light LV

CURETTE GRACEY - AF

CURETTE GRACEY - MF



1/2 Gracey
LV1807-02AF
 Leonardo Light LV
1807-02AF
 Asa60
ML1807-02AF
 Leonardo ML

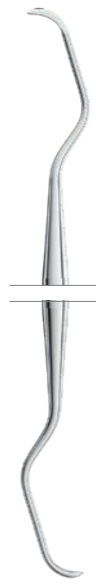

3/4 Gracey
1807-04AF
 Asa60
ML1807-04AF
 Leonardo ML
LV1807-04AF
 Leonardo Light LV



5/6 Gracey
1807-06AF
 Asa60
ML1807-06AF
 Leonardo ML
LV1807-06AF
 Leonardo Light LV

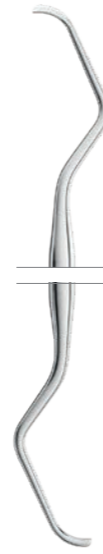

7/8 Gracey
1807-08AF
 Asa60
ML1807-08AF
 Leonardo ML
LV1807-08AF
 Leonardo Light LV



11/12 Gracey
1807-12AF
 Asa60
ML1807-12AF
 Leonardo ML
LV1807-12AF
 Leonardo Light LV



13/14 Gracey
1807-14AF
 Asa60
ML1807-14AF
 Leonardo ML
LV1807-14AF
 Leonardo Light LV

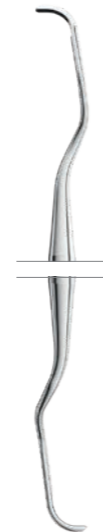

15/16 Gracey
1807-16AF
 Asa60
ML1807-16AF
 Leonardo ML
LV1807-16AF
 Leonardo Light LV



1/2 Gracey
LV1807-02MF
 Leonardo Light LV
1807-02MF
 Asa60
ML1807-02MF
 Leonardo ML



3/4 Gracey
1807-04MF
 Asa60
ML1807-04MF
 Leonardo ML
LV1807-04MF
 Leonardo Light LV



5/6 Gracey
1807-06MF
 Asa60
ML1807-06MF
 Leonardo ML
LV1807-06MF
 Leonardo Light LV

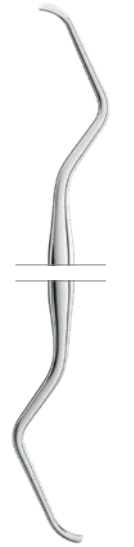

7/8 Gracey
1807-08MF
 Asa60
ML1807-08MF
 Leonardo ML
LV1807-08MF
 Leonardo Light LV



11/12 Gracey
1807-12MF
 Asa60
ML1807-12MF
 Leonardo ML
LV1807-12MF
 Leonardo Light LV

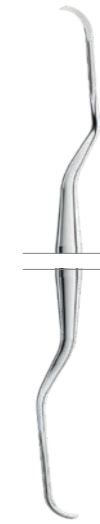

13/14 Gracey
1807-14MF
 Asa60
ML1807-14MF
 Leonardo ML
LV1807-14MF
 Leonardo Light LV

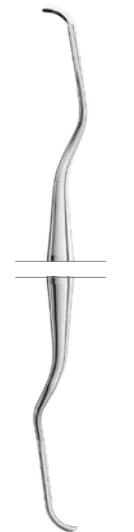

15/16 Gracey
1807-16MF
 Asa60
ML1807-16MF
 Leonardo ML
LV1807-16MF
 Leonardo Light LV

SCALER



U15 Towner
ML1903
Leonardo ML
1903
Asa60

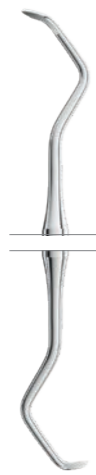

M23
Universal Scaler
1900-M23
Asa60
ML1900-M23
Leonardo ML
RC1900-M23/
RC1900-M23SF
● AsaWave RC

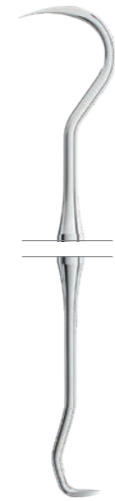

U15/33
Towner Jacquette
1902-1
Asa60
MV1902-1
Asa Light MV
ML1902-1
Leonardo ML
RC1902-1/
RC1902-1SF
● AsaWave RC

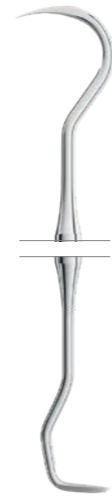

U15/30
Towner Jacquette
1902-2
Asa60
MV1902-2
Asa Light MV
RC1902-2/
RC1902-2SF
● AsaWave RC

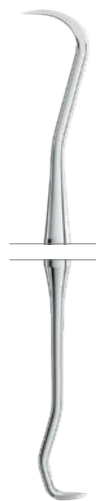

H5/33
1904-H5
Asa60
MV1904-H5
Asa Light MV
RC1904-H5/
RC1904-H5SF
● AsaWave RC

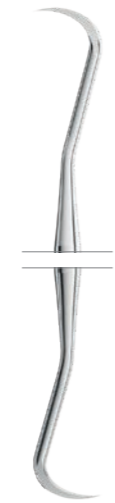

H6/H7
1904-H6
Asa60
MV1904-H6
Asa Light MV
RC1904-H6/
RC1904-H6SF
● AsaWave RC

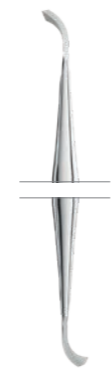

1/2
1905-02
Asa60
MV1905-02
Asa Light MV

SCALER



1
1901-1
Asa60



1L
left
1900-1L
Asa60



1R
right
1900-1R
Asa60



2L
left
1900-2L
Asa60



2R
right
1900-2R
Asa60



H5 Hygienist
1909-H5
Asa60



H6 Hygienist
1909-H6
Asa60



H7 Hygienist
1909-H7
Asa60



33
1906-33
Asa60



1 Jacquette
ML1906-1
Leonardo ML



2 Jacquette
ML1906-2
Leonardo ML



3 Jacquette
ML1906-3
Leonardo ML

SCOLLAPERIOSTIO ED ELEVATORI

3 mm
PUNTA LANCEOLATA



3 mm
PUNTA ARROTONDATA

Buser
PR1850-M
Perfection

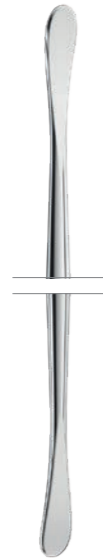

GF Goldman-Fox
MV1850-GF
Asa Light MV



M7 Molt
MV1850-M7
Asa Light MV

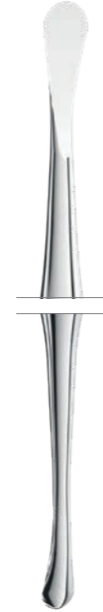

M8 Molt
MV1850-M8
Asa Light MV



M9 Molt
MV1850-M9
Asa Light MV

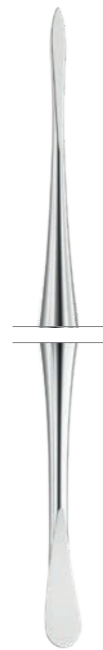

Beale
5114-1
Ottagonale



9A Allen
MV1850-9A
Asa Light MV



2 Hourigan
MV1851-2
Asa Light MV



PR3 Prichard
MV1851-PR3
Asa Light MV

SCOLLAPERIOSTIO ED ELEVATORI



1 Hopkins
MV1852-1
Asa Light MV



2 Hopkins
MV1852-2
Asa Light MV



Partsch
14,5 cm
1849-1
Asa60



3 Mead
MV1854-3
Asa Light MV



15 Freer
MV1853-15
Asa Light MV



16 Freer
MV1853-16
Asa Light MV

SCOLLAPERIOSTIO ED ELEVATORI

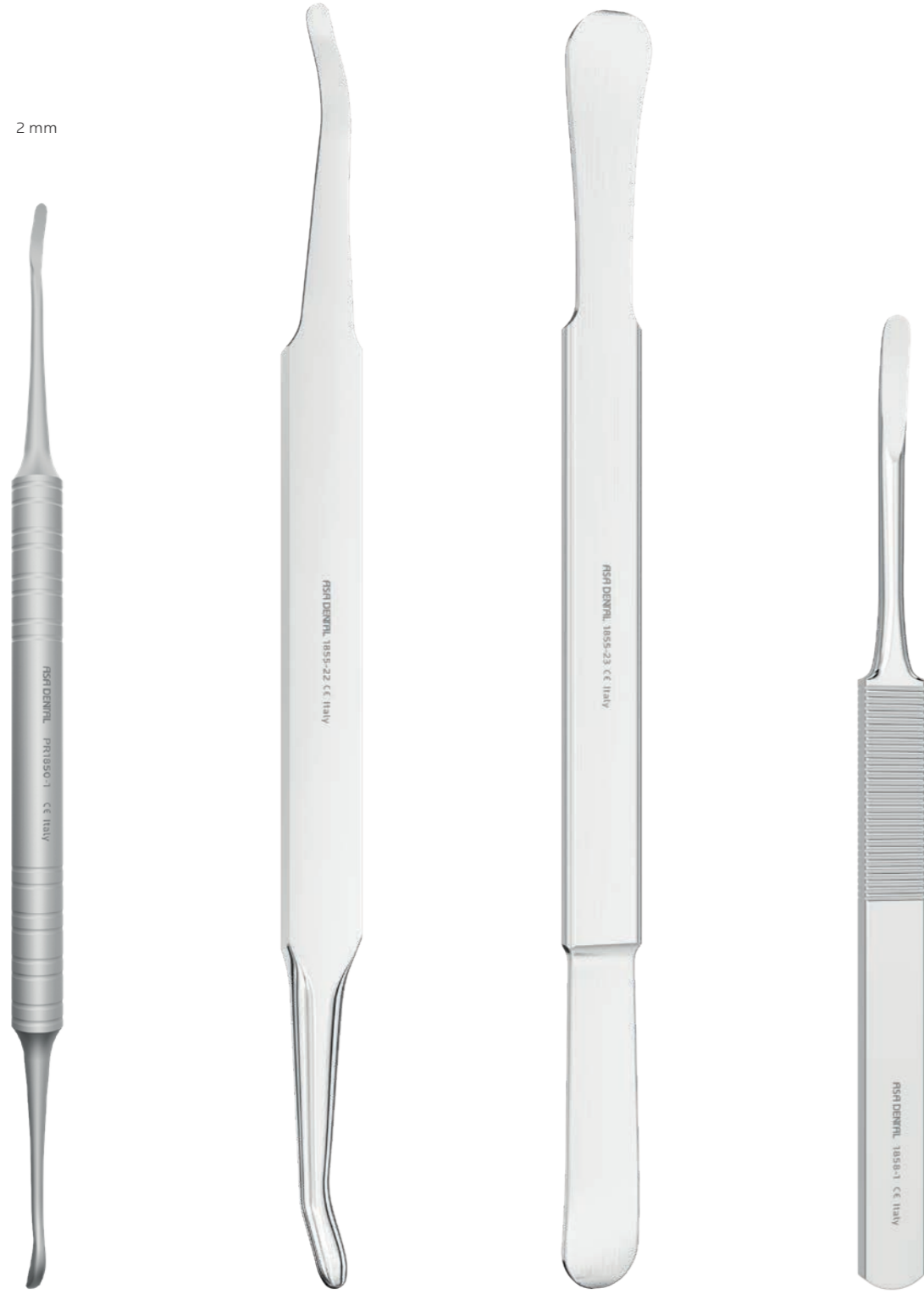

2 mm
17 cm
PR1850-1
Perfection

22 Seldin
divaricatore
1855-22

23 Seldin
divaricatore
1855-23

König
15,5 cm
1858-1

SCOLLAPERIOSTIO ED ELEVATORI



Williger
17 cm
1856-1

Williger
16 cm
1856-2

Williger
16 cm
1857-1

Williger
13 cm
1857-2

CUCCHIAI ALVEOLARI

1,8 mm

2,2 mm

2,9 mm

3,4 mm

5 mm

2,6 mm

3,2 mm

3,4 mm

1 Hemingway
2000-1
Asa60
MV2000-1
Asa Light MV
ML2000-1
Leonardo ML

2 Hemingway
2000-2
Asa60
MV2000-2
Asa Light MV
ML2000-2
Leonardo ML

3 Hemingway
2000-3
Asa60
MV2000-3
Asa Light MV
ML2000-3
Leonardo ML

4 Hemingway
2000-4
Asa60
MV2000-4
Asa Light MV
ML2000-4
Leonardo ML

85 Lucas
2001-85
Asa60
MV2001-85
Asa Light MV
ML2001-85
Leonardo ML
RC2001-85
● AsaWave RC

86 Lucas
2001-86
Asa60
MV2001-86
Asa Light MV
ML2001-86
Leonardo ML
RC2001-86
● AsaWave RC

87 Lucas
2001-87
Asa60
MV2001-87
Asa Light MV
ML2001-87
Leonardo ML
RC2001-87
● AsaWave RC

88 Lucas
2001-88
Asa60
MV2001-88
Asa Light MV
ML2001-88
Leonardo ML
RC2001-88
● AsaWave RC

CUCCHIAI ALVEOLARI

3 mm

3 mm

2,5 mm

3,5 mm

2,5 mm

3,5 mm

3,5 mm

3,5 mm

3,5 mm

3,5 mm

3,5 mm

3,5 mm

3,5 mm

3,5 mm

00/0 Williger
14 cm
2015-00

1/2 Williger
14 cm
2015-1

00/0
14 cm
2016-00

1/2
14 cm
2016-1

2
U.S.A. modello
16 cm
2013-2

2L
U.S.A. modello
16 cm
2013-2L

2R
U.S.A. modello
16 cm
2013-2R

0/1 Williger
14 cm
2015-0

0/1
14 cm
2016-0

LIME



3/7 Hirschfeld
1810-07
Asa60
MV1810-07
Asa Light MV

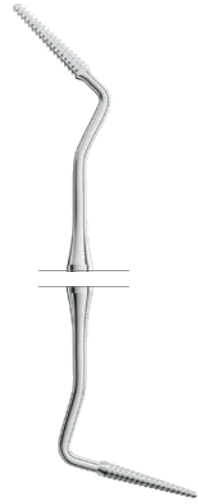

1S/2S Sugarman
1812-02S
Asa60
MV1812-02S
Asa Light MV

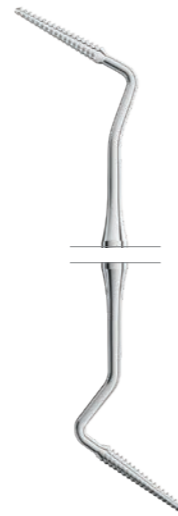

3S/4S Sugarman
1812-04S
Asa60
MV1812-04S
Asa Light MV

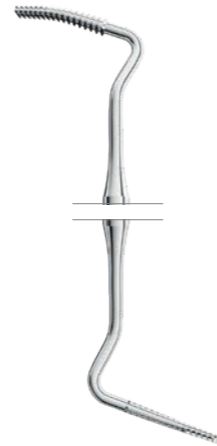

9/10 Schluger
1813-10
Asa60
MV1813-10
Asa Light MV

1812-04S

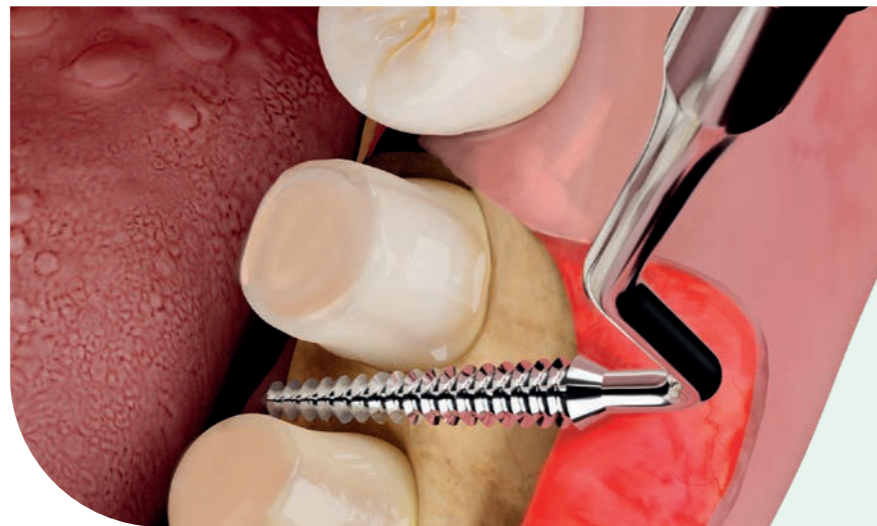

LIME PER ALVEOLOTOMIA



1 Polokoff
2003-1



33
2004-33



12 Howard
2008-12



45 Miller
2005-45



12A
2007-12A



64 Miller
2005-64



12CA
2007-12CA



10
2006-10



1 Wahl
MV2002-1
Asa Light MV



2 Wahl
MV2002-2
Asa Light MV

BISTURI PER GENGIVECTOMIA

BISTURI PER GENGIVECTOMIA



1 (15K) Kirkland
1803-1
Asa60



2 (16K) Kirkland
1803-2
Asa60



1 Orban
1804-1
Asa60



2 Orban
1804-2
Asa60

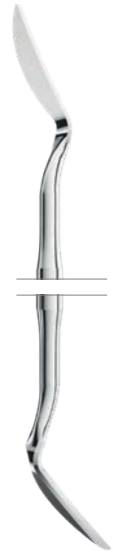

1/2 (15K/16K) Kirkland
1803-D
Asa60
MV1803-D
Asa Light MV
ML1803-D
Leonardo ML

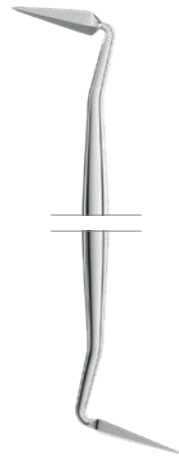

5/6 Buck
1816-06
Asa60
ML1816-06
Leonardo ML

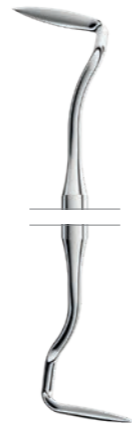

1/2 Orban
1804-D
Asa60
MV1804-D
Asa Light MV
ML1804-D
Leonardo ML



7 Goldman-Fox
1815-7
Asa60



8 Goldman-Fox
1815-8
Asa60



9 Goldman-Fox
1815-9
Asa60

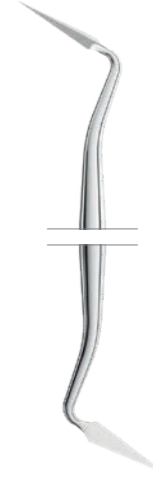

11 Goldman-Fox
1815-11
Asa60

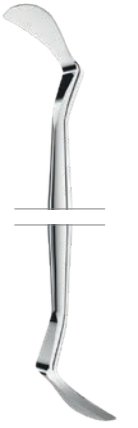

3/4 Buck
1816-04
Asa60



1/2 Sanders
1817-02
Asa60

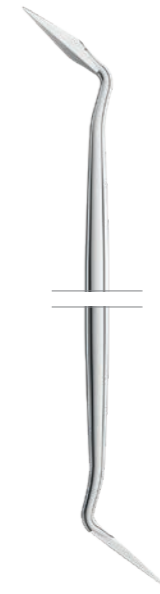

4/5 Sanders
1817-05
Asa60

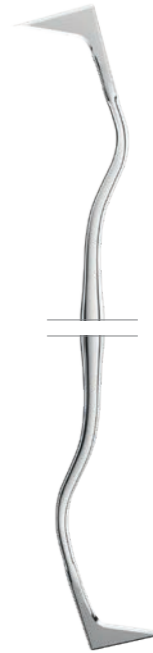

19/20
(University of South California)
USC Towner
1818-20
Asa60

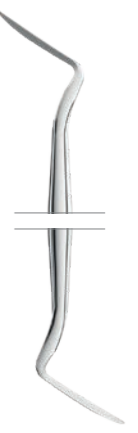

CK3 Crane-Kaplan
1819-CK3
Asa60

SCALPELLI CHIRURGICI

SCALPELLI E SGORBIE PER PARODONTOLOGIA



3 Ochsenein
1802-3
Asa60
MV1802-3
Asa Light MV

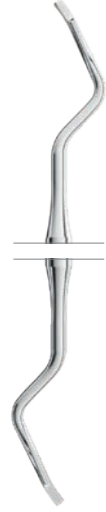

4 Ochsenein
1802-4
Asa60
MV1802-4
Asa Light MV



36/37 Rhodes back-action
1811-37
Asa60
MV1811-37
Asa Light MV



1 TG Chisel
1801-1
Asa60



2 TG Chisel
1801-2
Asa60



1/2 TG Chisel
1801-D
Asa60
MV1801-D
Asa Light MV



1 Ochsenein
1800-1



2 Ochsenein
1800-2



6 Gardner
1832-6



1 Gardner
1832-1



1W Wakefield
1833-1W



2 Gardner
1832-2



2W Wakefield
1833-2W



5 Gardner
1832-5



3 Buckley
1834-3



5R Gardner
1832-5R

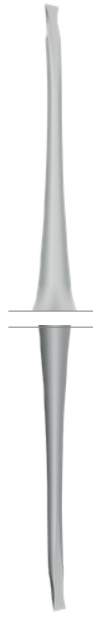

17 cm PR1801-1
Perfection

SCALPELLI E SGORBIE PER PARODONTOLOGIA

MARTELLI CHIRURGICI

3 mm



Partsch
13,5 cm
1835-3

4 mm



Partsch
13,5 cm
1835-4

5 mm



Partsch
13,5 cm
1835-5

6 mm



Partsch
13,5 cm
1835-6

3 mm



Partsch
13,5 cm
1837-3

4 mm



Partsch
13,5 cm
1837-4

5 mm



Partsch
13,5 cm
1837-5

6 mm



Partsch
13,5 cm
1837-6

3 mm



Partsch
17 cm
1836-3

4 mm



Partsch
17 cm
1836-4

5 mm



Partsch
17 cm
1836-5

6 mm



Partsch
17 cm
1836-6

3 mm



Partsch
17 cm
1838-3

4 mm



Partsch
17 cm
1838-4

5 mm



Partsch
17 cm
1838-5

6 mm



Partsch
17 cm
1838-6

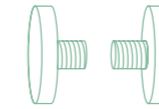

1881-R
coppia inserti di
ricambio in Teflon
autoclavabili
max 120°

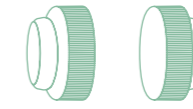

inserti
intercambiabili
in Ferrozell



Partsch
19 cm
1880
con piombo



Mead
19,5 cm
1881



Mead
17 cm
1882



Vickers
19 cm
1884



Herbert
19 cm
1885

STRUMENTI PER PARODONTOLOGIA

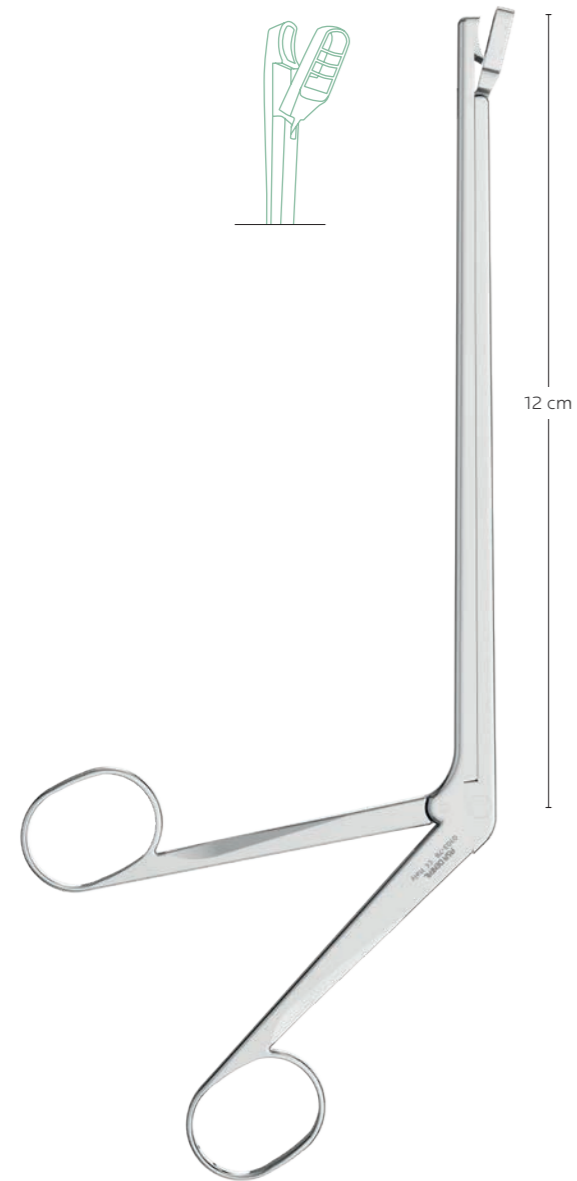

Tomati
19 cm
0103-78
ulocistotomo



Goldman-Fox
10 cm
0103-60
pinza per tessuti
dimensioni ridotte per
accesso
in aree molto limitate



Mini Friedman
12 cm
0103-25
pinza ossivora

PINZETTE PER MARCARE LE TASCHE



0650-2

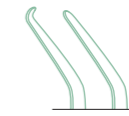

1 (Crane-Kaplan)
Goldman-Fox
15 cm
0650-1

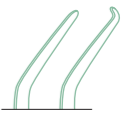

2 (Crane-Kaplan)
Goldman-Fox
15 cm
0650-2

PIETRE PER AFFILARE

Pietre in corindone

India, beige, per affilare gli strumenti molto smussati

75 x 45 x 2-7 mm

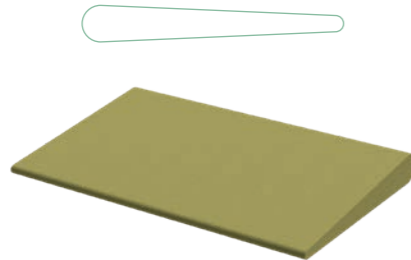

grana fine
1890-1F

75 x 45 x 2-7 mm

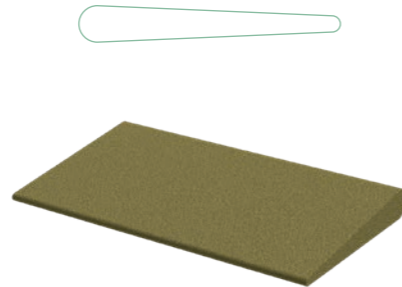

grana media
1890-1M

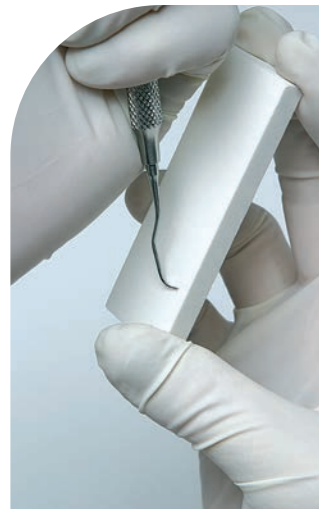

75 x 25 x 7 mm



1890-2

pietra per affilare "Arkansas" bianco grigiastro, per l'affilatura ripetuta e la finitura degli strumenti levatartaro e delle curette.

100 x 25 x 10 mm



1890-3

pietra per affilare Super "Arkansas", bianca, per affilatura ripetuta e finitura degli strumenti levatartaro e delle curette.

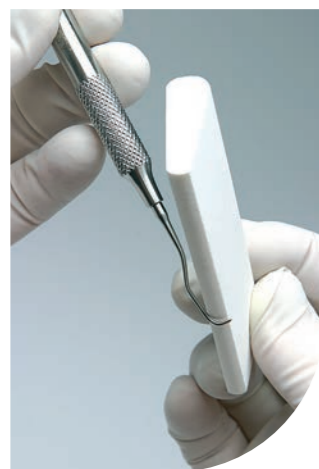

102 x 26 x 5-10 mm



1890-4

pietra Arkansas con bordo convesso per rifinire l'affilatura.

100 mm x Ø 6 mm

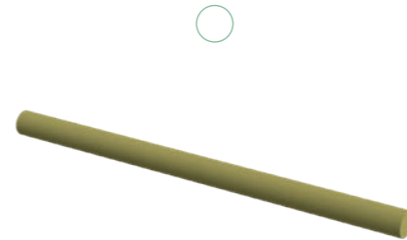

1890-5

pietre per affilare India, in corindone, lima rotonda, beige scuro, per togliere sbavature dalle estremità.

PIETRE PER AFFILARE



100 mm x max Ø 10 mm

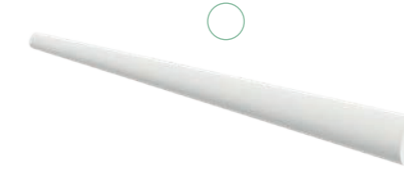

1890-6

pietra per affilare "Arkansas", lima rotonda, bianca grigiastro, per togliere sbavature dalle estremità.

102 x 8 mm - 15 x 2 - 6 mm



1890-7

pietra per affilare in carburo di silicio, conica, verde, per togliere sbavature dall'estremità.



100 mm x max Ø 10 mm



1891-1

barra di prova di plexiglass per controllare l'efficienza del taglio degli strumenti levatartaro e delle curette 6 pz / confezione.

155 x 80 x 120 mm



S1890

cassetta con supporti completa di pietre per affilare e olio.



Asa Oil
40 ml
8001

olio per affilatura strumenti, non dannoso fisiologicamente.

KIT CURETTE GRACEY

Set da 3



Modello	Codice Set	Manico
08 · 12 · 14	S1807-3	Asa60

Set da 3



Modello	Codice Set	Manico
08AF · 12AF · 14AF	S1807AF-3	Asa60

Set da 3



Modello	Codice Set	Manico
08MF · 12MF · 14MF	S1807MF-3	Asa60

Set da 7

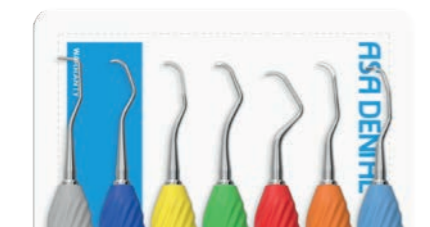

Modello	Codice Set	Manico
02 · 04 · 06 · 08 · 10 · 12 · 14	S1807	Asa60
02 · 04 · 06 · 08 · 10 · 12 · 14	SMV1807	Asa Light MV
02 · 04 · 06 · 08 · 10 · 12 · 14	SML1807	Leonardo ML
02 · 04 · 06 · 08 · 10 · 12 · 14	SLV1807	Leonardo Light LV
02 · 04 · 06 · 08 · 10 · 12 · 14	SRC1807	AsaWave RC

Set da 7



Modello	Codice Set	Manico
02AF · 04AF · 06AF · 08AF · 12AF · 14AF · 16AF	S1807AF	Asa60
02AF · 04AF · 06AF · 08AF · 12AF · 14AF · 16AF	SML1807AF	Leonardo ML
02AF · 04AF · 06AF · 08AF · 12AF · 14AF · 16AF	SLV1807AF	Leonardo Light LV

Set da 7



Modello	Codice Set	Manico
02MF · 04MF · 06MF · 08MF · 12MF · 14MF · 16MF	S1807MF	Asa60
02MF · 04MF · 06MF · 08MF · 12MF · 14MF · 16MF	SML1807MF	Leonardo ML
02MF · 04MF · 06MF · 08MF · 12MF · 14MF · 16MF	SLV1807MF	Leonardo Light LV

KIT DI STRUMENTI PER PARODONTOLOGIA



S1899

0304-2	forbicina Goldman-Fox curva	2
0650-1	pinzetta per marcare le tasche Goldman-Fox destra	1
0650-2	pinzetta per marcare le tasche Goldman-Fox sinistra	2
0703L-1	sonda millimetrica parodontale Williams	
1803-D	bisturi per gengivectomia Kirkland	15K/16K
1804-D	bisturi per gengivectomia Orban	1/2
1807-06	curette Gracey	5/6
1807-12	curette Gracey	11/12
1807-14	curette Gracey	13/14
1809-1	scaler Goldman-Fox	1
1816-06	bisturi per gengivectomia Buck	5/6
1825-14	scaler Mc Call	13/14
1829-CK6	scaler Crane-Kaplan	6
1903	scaler Towner	U15
MV1850-M9	scollaperiostio Molt	M9

KIT DI STRUMENTI PER PARODONTOLOGIA

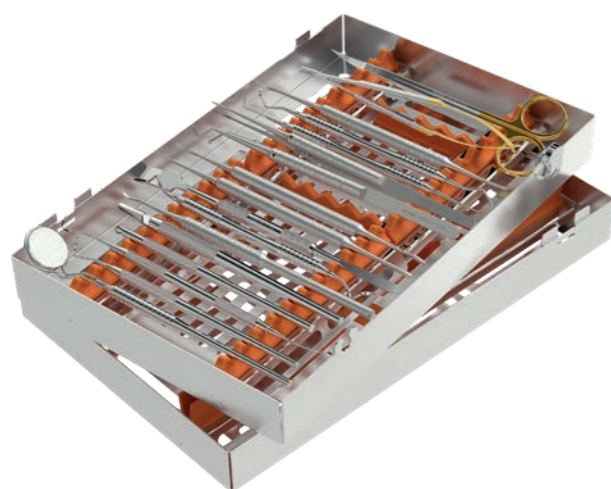

Kit chirurgia parodontale
SPR2781-P

ML2101	manico per specchietti	
2230-5	specchietto doppio	5
0702L-15	sonda millimetrica parodontale	CP-15
0708L-2N	sonda doppia millimetrica parodontale	2N
0365-1	manico per micro lame	
0350-5	manico per bisturi e lama	5
PR1857-1	dissetto	
ML1804-D	bisturi per gengivectomia Orban	1/2
MV1851-PR3	scollaperiostio Prichard	PR3
PR1850-M	scollaperiostio	
PR1850-1	scollapapilla	
PR0625-3	pinzetta per sutura	
PR0632-1	pinzetta chirurgica atraumatica	
ML1806-2RL	strumento parodontale	2R/2L
ML1806-4RL	strumento parodontale	4R/4L
PR1801-1	scalpello da osso	
PR0460-15TC	porta aghi Castroviejo	
0309-2TC	forbicina per gengive	2TC
2780-1A	cassetta portastrumenti	



Kit prima visita parodontale
S0600-1

2102-IN	manico per specchietti	
2200-4	specchietto piano	4
0704-23D1	sonda doppia	23/17
0708-1N	sonda parodontale	1N
0702L-12	sonda millimetrica parodontale	CP-12
0601-2	pinzetta per medicazione London-College	2
S2702	vassoio forato completo di griglia	

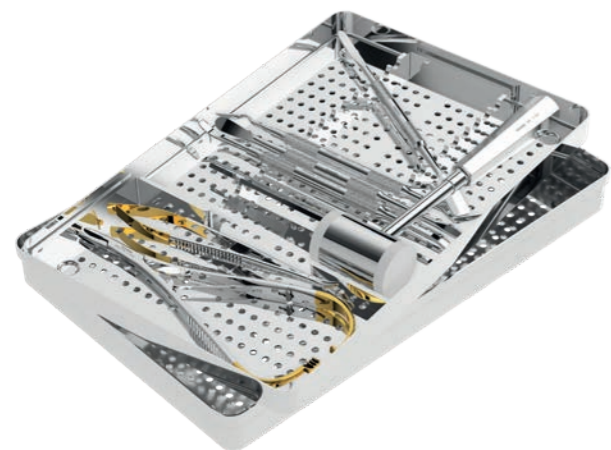

S3003-9

MV1850-M9	scollaperiostio Molt	M9
MV1851-PR3	scollaperiostio Prichard	PR3
MV1850-GF	scollaperiostio Goldman-Fox	GF
MV1803-D	bisturi Kirkland	15K/16K
1881	martello Mead	
0446TH-14TC	porta aghi Castroviejo	
0435-17TC	porta aghi Mathieu	
0350-3	manico per bisturi	3
S2722-1	vassoio forato completo di griglia	

KIT DI STRUMENTI PER PARODONTOLOGIA



S3003-11

0350-3	manico per bisturi	3
2602-1	divaricatore Sternberg	
0304-2	forbicine Goldman-Fox	2
MV1850-M9	scollaperiostio Molt	M9
MV1851-PR3	scollaperiostio Prichard	PR3
0415-15TC	porta aghi Crile-Wood	
0631-1	pinzetta chirurgica Semken Taylor	1
0700-23	sonda	23
2102-IN	manico per specchietto	
2200-5	specchietto piano	5
0351-11	lame per bisturi (100 pz)	11
S2722-1	vassoio forato completo di griglia	

Set di strumenti realizzato secondo le indicazioni del Prof. Guido Goracci, titolare della Cattedra di Odontoiatria Conservatrice presso l'Università degli studi di Roma "La Sapienza".



S1800-23

1811-37	lima Rhodes back-action	36/37
1803-1	bisturi Kirkland	15K
1816-04	bisturi Buck	3/4
1815-7	bisturi Goldman-Fox	7
1817-02	bisturi Sanders	1/2
1805-02	curette Langer	HU 1/2
1821-06	scaler Bernhart	5/6
1823-R04	scaler Rule	3/4
1808-1	scaler De Marco	1
1809-5	scaler Goldman-Fox	5
1809-6	scaler Goldman-Fox	6
1825-12	curette McCall	11/12
1825-12A	curette McCall	11A/12A
1827-204	curette	204
1831-32	curette Jacquette	31/32
1904-H5	curette	H5/33
1810-07	lima Hirschfeld	3/7
1812-02S	lima Sugarman	1S/2S
1812-04S	lima Sugarman	3S/4S
1801-D	scalpello	1/2
1808-2	scaler De Marco	2
1803-2	bisturi Kirkland	2
1802-4	scalpello Ochsenbein	4
S2720-2	vassoio con base forata completo di griglia	

ORTODONZIA

MADE IN ITALY



LA QUALITÀ AL GIUSTO PREZZO

Ogni specialista, indipendentemente dal tipo di intervento da attuare, necessita di strumenti e apparecchiature affidabili che permettano di lavorare con tranquillità ed efficacia. A tal proposito, noi di Asa Dental offriamo due diverse linee di prodotti: la prima, la linea standard, è composta da strumenti che offrono il compromesso ottimale tra prezzo e prestazioni ed è stata progettata come gamma di prodotti accessibile a tutti. La seconda, la Linea Premium, è una varietà di strumenti che si rivolge a quei professionisti che richiedono ergonomia e qualità ai massimi dell'eccellenza in qualsiasi circostanza. Perché crediamo nell'eccellenza e ambiamo alla perfezione, ma desideriamo, in primis, che tutti possano accedere a cure dentali di qualità.

I4 Tronchesi

I10 Pinze per piegare fili

I29 Pinze di utilità

I34 Strumenti per ortodonzia

I37 Contenitori per protesi

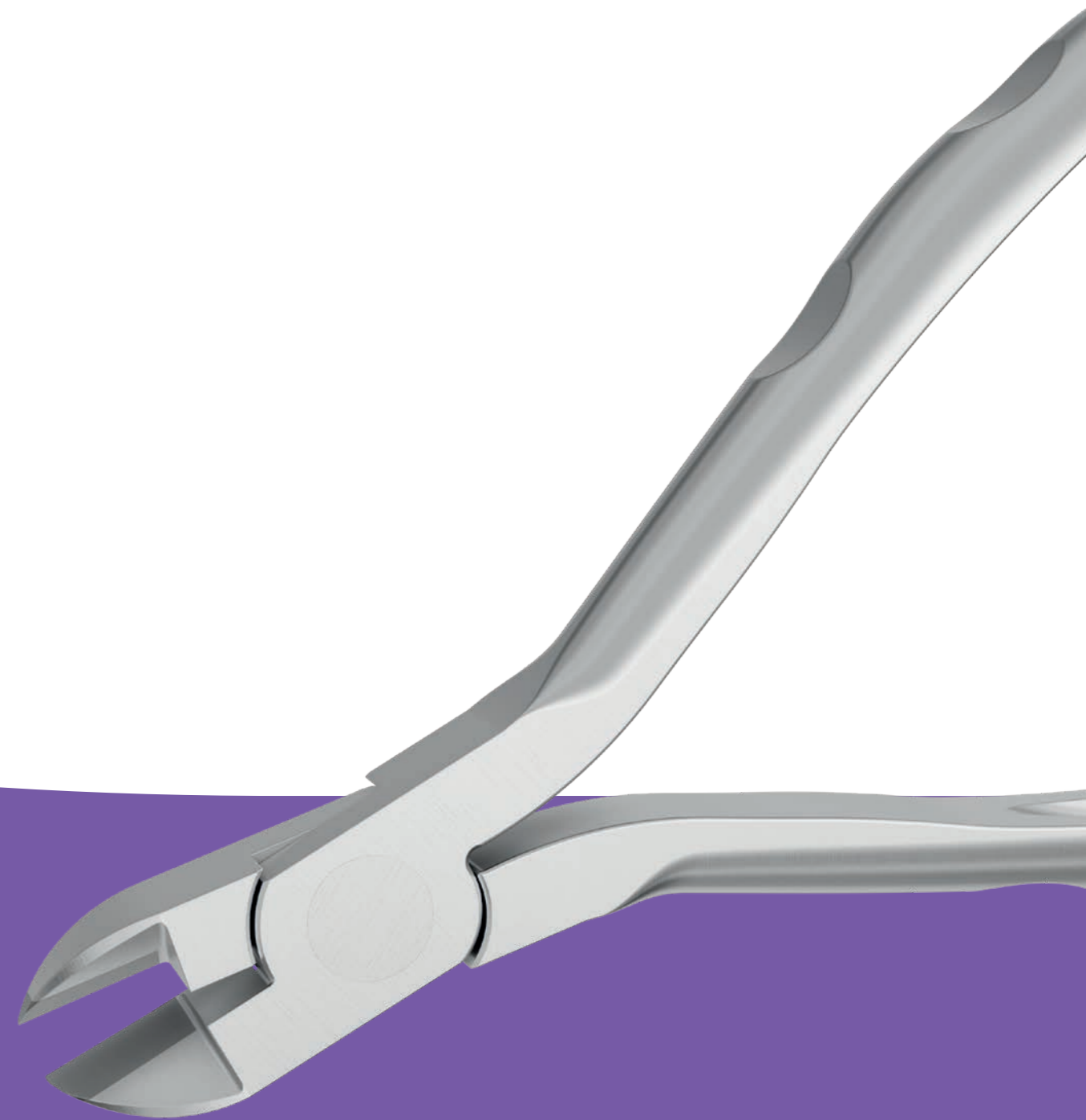

COME LEGGERE QUESTO CAPITOLO



Strumento Premium per ortodonzia



Strumento Premium per ortodonzia con inserti al carburo di tungsteno (TC)



Strumento standard

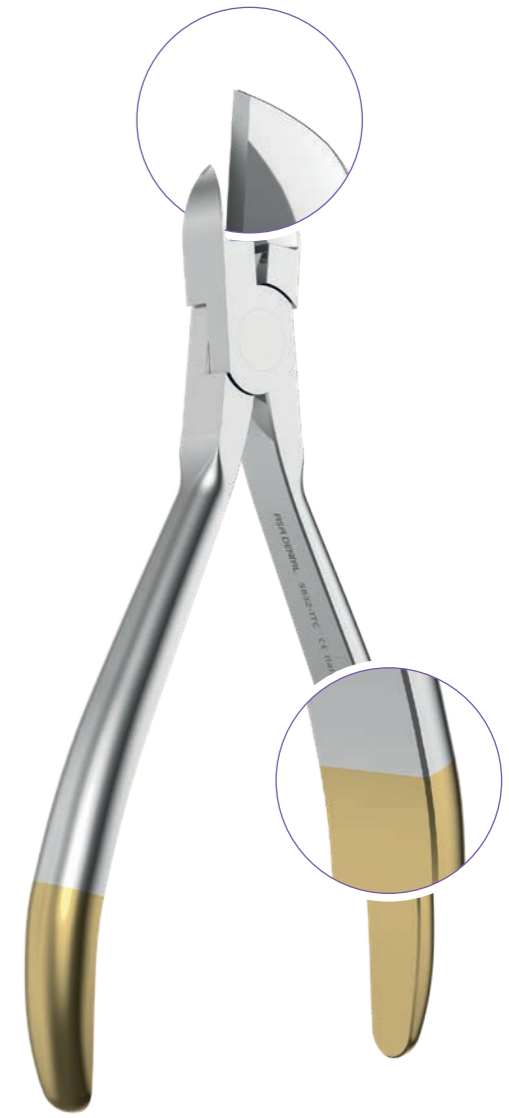

Strumento standard con inserti al carburo di tungsteno (TC)

COME USARE LE INFORMAZIONI

quando la vista intera e quella parziale compaiono nella stessa pagina, lo strumento è disponibile sia nella versione Premium che in quella standard.

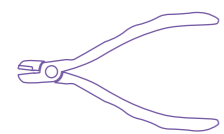

Vista intera strumento Premium per ortodonzia codice con prefisso 88

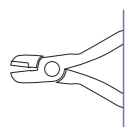

Vista parziale strumento standard codice con prefisso 58

DISEGNO TECNICO



I disegni forniscono dettagli aggiuntivi sulla forma di uno strumento

TRONCHESI



tronchese per filo duro a 15°
8812-2TC

L'inclinazione a 15° permette di raggiungere agevolmente le zone di difficile accesso.

Dimensioni del filo:
max. 0,56 mm x 0,70 mm
(0,022" x 0,028")



tronchese distale universale
senza trattenuta del filo
8813-1TC

Tronchese distale universale Mini, senza trattenuta del filo. Taglio preciso di bracket e tubi boccali.

Dimensioni del filo:
max. 0,56 mm x 0,70 mm (0,022" x 0,028")

TRONCHESI

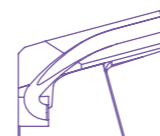

tronchese distale a taglio netto
8826-1TC

Tronchese distale a taglio netto con inserti in metallo duro.

Dimensioni del filo:
max. 0,56 mm x 0,70 mm
(0,022" x 0,028")



tronchese distale universale
8814-1TC

Tronchese distale universale Mini, con trattenuta del filo per garantire la sicurezza e il comfort del paziente durante l'uso.

Dimensioni del filo:
max. 0,56 mm x 0,70 mm (0,022" x 0,028")

TRONCHESI



tronchese mini per legature
8824-1TC

Tronchese Mini per legature, dritta.
Profilo ultrasottile per raggiungere
agevolmente le zone di difficile accesso.

Dimensioni filo:
max. 0,40 mm (0,015")



tronchese micro per legature a 15°
8827-1TC

Tronchese Micro per legature e taglio
di filo duro, con lama inclinata a 15°.
Profilo ultrasottile per raggiungere
agevolmente le zone di difficile accesso.

Dimensioni filo:
max. 0,40 mm (0,015")

TRONCHESI



tronchese per fili multiuso
8812-1TC

Tronchese versatile per il taglio di filo duro.

Dimensioni filo:
max. 0,56 mm x 0,70 mm
(0,022" x 0,028")



tronchese per fili multiuso
5832



tronchese per fili multiuso
5832-1TC

Stesse caratteristiche del 5832
con l'aggiunta di inserti in carburo di tungsteno

TRONCHESI



**Tronchese in miniatura per recidere fili
5833**

Tronchese per legature micro, adatto per filo morbido. Profilo ultrasottile per raggiungere agevolmente le zone di difficile accesso.

Dimensioni filo:
max. 0,30 mm (0,012")

**Tronchese in miniatura per recidere fili
5833-1TC**

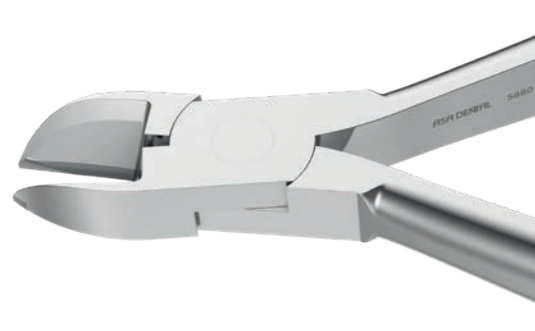
Stesse caratteristiche del 5833 con l'aggiunta di inserti in carburo di tungsteno

**tronchese per filo <= 0,9 mm
5880-1**

Tronchese per filo duro, adatto a legature e perni di bloccaggio. Consente di piegare le estremità del filo dopo il taglio distale.

Dimensioni filo:
max. 0,9 mm (0,036")

**tronchese per filo <= 1,5 mm
5880-2**

Tronchese per filo duro, adatto a legature e perni di bloccaggio. Consente di piegare le estremità del filo dopo il taglio distale.

Dimensioni filo:
max. 1,5 mm (0,044")

TRONCHESI

**tronchese per filo <= 1,2 mm
5880-3TC**

Tronchese per filo duro, adatto a legature e perni di bloccaggio. Consente di piegare le estremità del filo dopo il taglio distale. Con inserti in carburo di tungsteno.

Dimensione del filo:
max. 1,2 mm (0,044")

**tronchese per taglio distale
5836**

Tronchese distale per filo duro, con trattenuta del filo per garantire la sicurezza e il comfort del paziente durante l'uso.

Dimensioni del filo:
sezione rettangolare max.
0,56 mm x 0,7 mm (0,022" x 0,028")
sezione circolare max. 0,5 mm (0,020")

**tronchese per taglio distale
5836-1TC**

Stesse caratteristiche del 5836-1TC con l'aggiunta di inserti in carburo di tungsteno

**tronchese per taglio distale micro
5837**

Tronchese distale per filo duro, con trattenuta del filo per garantire la sicurezza e il comfort del paziente durante l'uso.

Dimensioni del filo:
sezione rettangolare max.
0,56 mm x 0,7 mm (0,022" x 0,028")
sezione circolare max. 0,5 mm (0,020")

PINZE PER PIEGARE FILI



pinza universale Delphin
8801-1

Dimensioni filo (piegatura):
max. 0,90 mm (0,035")

Dimensioni filo (taglio):
max. 0,70 mm (0,028")



pinza universale
Delphin
5801-1



pinza universale
5801-3



pinza universale
8801-2

Dimensioni filo (piegatura):
max. 0,90 mm (0,035")

Dimensioni filo (taglio):
max. 0,70 mm (0,028")

PINZE PER PIEGARE FILI



pinza Waldsachs
8802

Dimensioni filo (piegatura):
max. 0,90 mm (0,035")

Dimensioni filo (taglio):
max. 0,70 mm (0,028")



pinza Waldsachs
5802

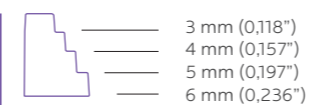

pinza di precisione Nance
8816

Per la creazione di anelli precisi in 4 diverse misure:
3, 4, 5 e 6 mm. La scanalatura alla base favorisce la
chiusura degli anelli.

Dimensioni filo:
max. 0,70 mm (0,028")

PINZE PER PIEGARE FILI

**pinza Nance
5800**

Pinza per la chiusura loop, per la formazione di stop su archi e per la formazione di ganci Adams.

Dimensioni filo:
max. 0,7 mm (0,028")

**pinza concava-convessa
5806**

Pinza con un becco concavo e uno tondo per la formazione di pieghe ad ansa e loop su fili sottili a sezione quadrata e circolare.

Dimensioni filo:
max. 0,5 mm (0,020")

**pinza Tweed per anse
5809-1**

Pinza Tweed per la formazione di loop su fili a sezione quadrata e circolare, con becco cilindrico sostituibile a tre sezioni. Il becco concavo ha dentellature parallele per mantenere il filo in posizione.

Dimensioni filo:
max. 0,56 x 0,7 mm (0,022"x 0,028")

Dimensioni becco:
1,15 mm (0,045"), 1,50 mm (0,059"), 1,90 mm (0,075")

PINZE PER PIEGARE FILI

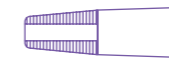

1,20 mm (0,047")
1,60 mm (0,063")
2,00 mm (0,075")

**pinza Omega Tweed
8804-2**

Pinza per la formazione di loop Omega su fili a sezione quadrata e circolare, con becco cilindrico sostituibile a tre sezioni. Il becco concavo ha dentellature parallele per mantenere il filo in posizione.

Dimensioni filo:
max. 0,70 mm (0,028")

**pinza Omega Tweed
5809-2****8804-2P**

Punta di ricambio per pinza 8804-2

**8804-3P**

Vite di ricambio e chiave per pinza 8804-2

PINZE PER PIEGARE FILI



1,60 mm (0,063")
2,20 mm (0,087")
2,80 mm (1,100")

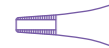

pinza Tweed universale
8804-1

Pinza per la formazione di loop elicoidali e loop di bull con diametri multipli.

Dimensioni filo:
max. 0,70 mm (0,028")



pinza Tweed universale
5870



pinza Young
5863



pinza Young
8817

Pinza per la formazione di loop di diverse dimensioni ideali per archi labiali.

Dimensioni filo:
max 0,70 mm (0,028")

PINZE PER PIEGARE FILI



pinza Tweed per anse
5809-3

Pinza per la formazione di loop con un becco cilindrico a dimensione fissa e un becco concavo dotato di dentellature.

Dimensioni filo:
max. 0,56 x 0,7 mm (0,022" x 0,28")

Dimensioni becco:
1,50 mm (0,059")



pinza Tweed (Angle)
5872-1

Pinza a becchi corti (10mm) per la formazione di archi rettangolari su fili a sezione quadrata e rettangolare. Le lame risultano parallele ad un'apertura di 0,5 mm (0,020")

3 mm (0,118")
4 mm (0,157")
5 mm (0,197")
6 mm (0,236")

pinza Nance per anse
5862

Pinza progettata per formare loop in 4 diverse misure su fili a sezione circolare e rettangolare.

Dimensioni filo:
max. 0,7 mm (0,028")



PINZE PER PIEGARE FILI



**pinza Reynolds
8805**
Pinza per modellazione



**pinza Reynolds
5812**

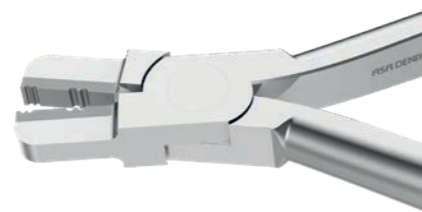

**pinza per arco
linguale
5818**

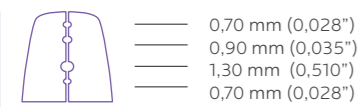

**pinza per arco linguale
8807-3**
0,76 mm - 0,90 mm (0,030" - 0,036")
Dimensioni filo:
max. 0,90 mm (0,036")

PINZE PER PIEGARE FILI



**pinza mini per piegare archi
8807-1**
1,30 mm (0,050")
Dimensioni filo:
max. 0,56 mm x 0,64 mm (0,022" x 0,025")



**pinza per piegare archi
8807-2**
1,78 mm (0,067")
Dimensioni filo:
max. 0,56 mm x 0,64 mm (0,022" x 0,025")

PINZE PER PIEGARE FILI



Pinza De La Rosa scanalata
5821-1

Pinza per formare archi e modellare contorni su fili a sezione circolare e rettangolare. Le misure delle guide sul becco sono di 0,4 mm (0,016"), 0,46 mm (0,018") e 0,56 mm (0,022")

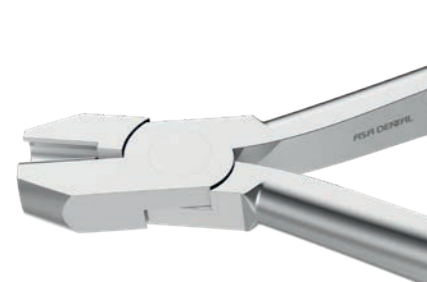

Pinza De La Rosa non scanalata
5821-2

Pinza per formare archi e modellare contorni su fili a sezione circolare e rettangolare, priva di guide



pinza Mc Kellops
5860-1

Pinza concava-convessa per filo duro, adatta per formare loop su fili da ganci o per archi labiali.

Dimensioni filo:
max. 0,8 mm (0,032")



pinza piegafili piatta
5864

Pinza con punte piatte per piegare fili.

Dimensioni filo:
max. 0,9 mm (0,036")

PINZE PER PIEGARE FILI



pinza a punte arrotondate corta
5865

Pinza a punte coniche per piegare fili e per ganci.

Dimensioni filo:
max. 0,7 mm (0,028")

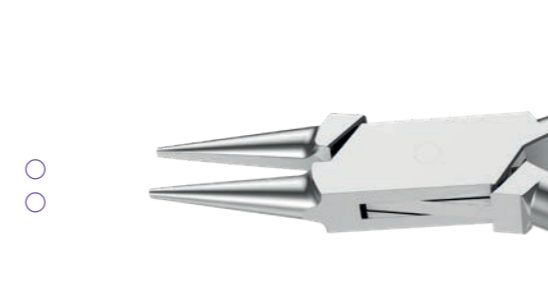

pinza a punte arrotondate lunga
5868

Pinza a punte coniche per piegare fili e per ganci.

Dimensioni filo:
max. 0,7 mm (0,028")



pinza Angle
5866

Pinza Angle a becco d'uccello per piegare fili a sezione circolare, quadrata e rettangolare.

Dimensioni filo:
max. 0,7 mm (0,028")



pinza Angle con lama
5838

Pinza Angle a becco d'uccello per piegare e tagliare fili a sezione circolare, quadrata e rettangolare.

Dimensioni filo:
max. 0,7 mm (0,028")

PINZE PER PIEGARE FILI

**pinza Adams
8819**
Pinza progettata per
piegare fili a 90°



**pinza Adams
13 cm
5867-1**



**pinza Adams
14 cm
5867-2**



**pinza Johnson
5861**



**pinza Johnson
8815**
Pinza per contornare corone e bande

PINZE PER PIEGARE FILI



**pinza Aderer mini
8820-1**
Pinza a tre punte corte per
piegare fili
Dimensioni filo:
max. 0,50 mm (0,020")



**pinza Aderer mini
5869-1**



**pinza Aderer
standard
5869-2**



**pinza Aderer standard
8820-2**
Pinza a tre punte corte per piegare fili
Dimensioni filo:
max. 0,70 mm (0,028")

PINZE PER PIEGARE FILI



**pinza a becco d'uccello
universale
8818**

Pinza versatile per la
formazione di loop



**pinza a becco d'uccello
8821**

Pinza a becco d'uccello per filo sottile con scanalatura. Il cono più lungo agevola la creazione precisa di loop, la scanalatura facilita il posizionamento e la duplicazione di loop.

Dimensioni filo:
max. 0,70 mm (0,028")



PINZE PER PIEGARE FILI



**pinza How universale
8822-1**

Pinza How, dritta. Le punte zigrinate la rendono ideale per il posizionamento e la rimozione di archi odontotecnici e perni



**pinza How
universale
5874-1**



**pinza How curva
5874-2**



**pinza How curva
8822-2**

Pinza How, curva. Le punte zigrinate e angolate a 40° la rendono ideale per raggiungere le zone di difficile accesso

PINZE PER PIEGARE FILI

D
O**pinza per filo leggero a becco d'uccello
5871**

Pinza con becchi lunghi progettata per piegare fili a sezione circolare, quadrata e rettangolare.

Dimensioni filo:
max. 0,4 mm (0,016")

**pinza piegafili piatta
5875-1**

Pinza a punte piatte, sottili e lisce, per qualsiasi piegatura di filo.

Dimensioni filo:
max. 0,7 mm (0,028")

**pinza piegafili piatta zigrinata
5875-2**

Pinza a punte piatte, sottili e zigrinate, per qualsiasi piegatura di filo.

Dimensioni filo:
max. 0,7 mm (0,028")

**pinza piegafili zigrinata
5876-1**

Dimensioni filo:
max. 0,7 mm (0,028")

**pinza piegafili
5876-2**

Dimensioni filo:
max. 0,7 mm (0,028")

PINZE PER PIEGARE FILI

**pinza Schwarz
8823**

Pinza Schwarz per formare ganci.

Dimensioni filo:
max. 0,70 mm (0,028")

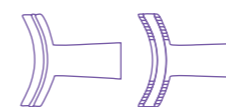
**pinza Hammerhead NiTi
8825**

Pinza multiuso per piegare fili in NiTi e formare loop senza l'impiego di calore

PINZE PER PIEGARE FILI



**pinza optical
8803**

Pinza con scanalatura, ideale per formare loop di chiusura su fili a sezione circolare e rettangolare.

Dimensioni filo:
max. 0,70 mm (0,028")



**pinza Hollow Chop
8806**

Pinza (De La Rosa) indicata per il contorno degli archi.

Dimensioni filo:
max. 0,70 mm (0,028")

PINZE PER PIEGARE FILI



**pinza Jarabak
8829**

Pinza multiuso per piegare fili leggeri. Le scanalature facilitano la precisione della piegatura e la chiusura dei loop.

Dimensioni filo:
max. 0,70 mm (0,028")



**pinza V-stop
8830**

Pinza progettata per creare pieghe a V sugli archi ortodontici, inclusi quelli in nichel titanio, e per prevenire la distocazione dell'arco.

Dimensioni filo:
max. 0,70 mm (0,028")

PINZE PER PIEGARE FILI



pinza Tweed universale
8804-1



pinza Adams
8819

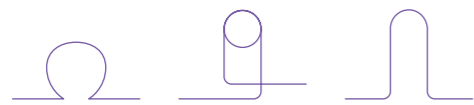

pinza Omega Tweed
8804-2

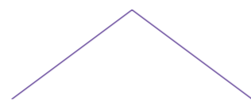

pinza Aderer mini
8820-1
pinza Aderer standard
8820-2



pinza mini per piegare archi
8807-1
pinza per piegare archi
8807-2

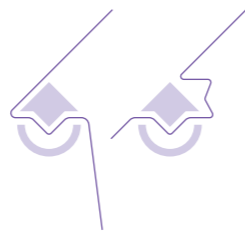

pinza Schwarz
8823



pinza per arco linguale
8807-3

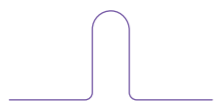

pinza di Nance
8816



pinza hammerhead NiTi
8825



pinza a becco d'uccello universale
8818
pinza a becco d'uccello
8821



pinza V-stop
8830

PINZE DI UTILITÀ

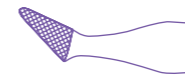

pinza Weingart
8808-1

Pinza ausiliaria Weingart con punte zigrinate, ideale per legature

pinza Weingart
5819

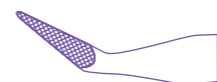

pinza Weingart sottile
8808-2

Pinza ausiliaria Weingart con punte sottili e zigrinate, ideale per legature

PINZE DI UTILITÀ



**pinza per rimozione bande
con punta larga
5826-1**

Pinza a becco largo per la rimozione di bracket adesivi. La punta affilata permette di entrare sotto la flangia dell'attacco e ne consente il distacco con estrema facilità, facilitando inoltre la totale rimozione dei residui di materiale adesivo



**Pinza per rimozione bande
con punta stretta
5826-2**

Pinza a becco stretto per la rimozione di bracket adesivi. Funzionalmente simile alla pinza 5826-1

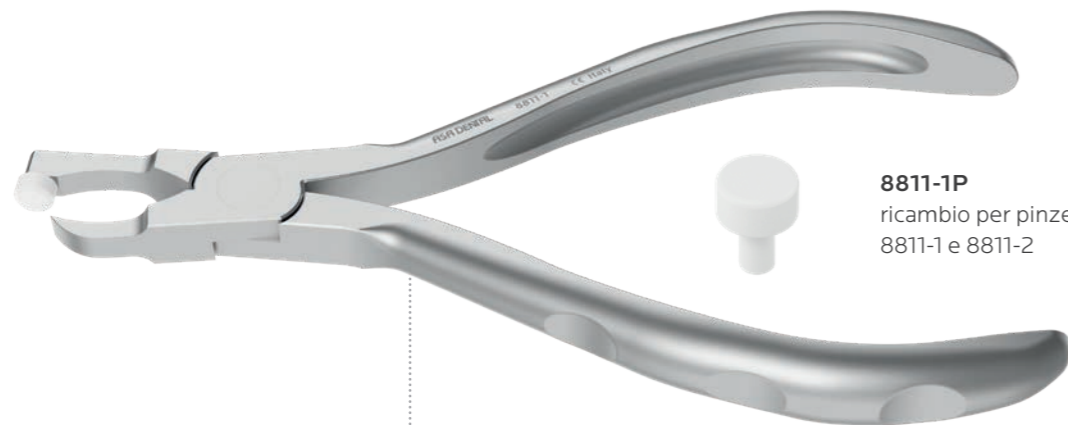

8811-1P
ricambio per pinze
8811-1 e 8811-2

**pinza rimozione bande posteriori
corta
8811-1**

Pinza per rimuovere bande e bracket posteriori, corta. La punta è allineata sotto il bordo inferiore del cuscinetto occlusale



**pinza rimozione bande posteriori corta
5828-1**

PINZE DI UTILITÀ



8811-1P
ricambio per pinze
8811-1 e 8811-2

**pinza rimozione bande
posteriori lunga
8811-2**

Pinza per rimuovere bande e bracket posteriori, lunga. La punta è allineata sotto il bordo inferiore del cuscinetto occlusale



**pinza rimozione
bande posteriori
lunga
5828-2**



**pinza larga per
rimozione bracket
5824-1**



**pinza larga per rimozione bracket
8809**

Pinza per rimuovere bracket, dritta. Adatta a tutti gli attacchi in acciaio, ceramica e plastica

PINZE DI UTILITÀ



**pinza anoglata per rimozione bracket
8810**

Pinza per rimuovere bracket, angolata.
Adatta a tutti gli attacchi
in acciaio, ceramica e plastica



**pinza curva per rimozione bracket
5825**



8831-1P
ricambio per pinze
8831

**pinza toglì adesivo
8831**

Pinza per rimuovere adesivo con lama
reversibile e sostituibile

PINZE DI UTILITÀ



**taglierina universale per bande
8828-1TC**

Taglierina per bande.

Dimensioni filo:
max. 0,40 mm (0,015")



8828-1TC

STRUMENTI PER ORTODONZIA

STRUMENTI PER ORTODONZIA

Strumenti per legature

Pinzette per posizionare attacchi adesivi

la presa è automatica e il rilascio avviene soltanto quando la pinzetta viene premuta

Spingibande

Adattatori di bande
con inserto di stagno

Spingibande
sterilizzabile in autoclave a vapore saturo

Strumenti per montare e rimuovere bande

Strumento per elastici

Pinza tendielastici per catenelle e separatori



13,5 cm
2400

13,5 cm
2402

13,5 cm
2401

Mershon
14 cm
2410

15 cm
2411

13,5 cm
2412



1350-1

1350-2

1351-1

1352-1

15,5 cm
2450

STRUMENTI PER ORTODONZIA

Marker per il posizionamento di bracket
 misure disponibili 3,5 / 4,0 / 4,5 / 5,0 mm



8832

Per legature elastiche

2 mm

3 mm



Luniatschek
1355-1



Luniatschek
1355-2

Pinzette per elastici

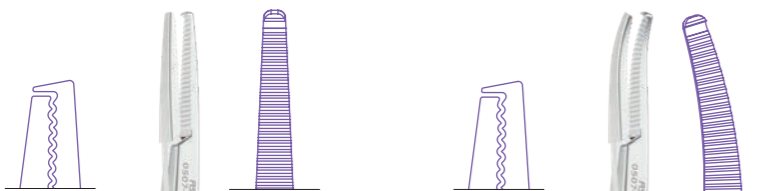

1 Halstead-Mosquito
retta
12 cm
0507-1



2 Halstead-Mosquito
curva
12 cm
0507-2

CONTENITORI PER PROTESI/ORTODONTICI

Scatola in plastica antiurto per apparecchi ortodontici mobili
 10 pz / confezione



Blu
6900E-A



Bianco
6900E-B



Azzurro
6900E-C



Giallo
6900E-G



Rosa
6900E-R



Verde
6900E-V

VASSOI E CONTENITORI

MADE IN ITALY

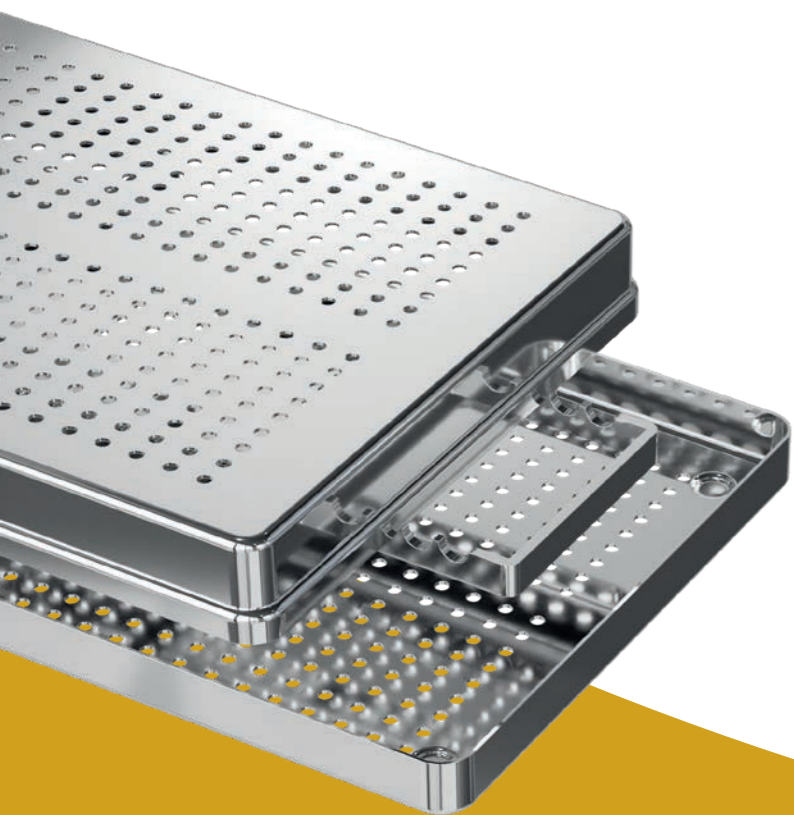

L'EFFICIENZA OPERATIVA, SEMPLIFICATA

Uno studio dentale che cresce per numero di interventi e personale qualificato richiede procedure ancora più efficaci. L'efficienza operativa diventa una conseguenza diretta di una pratica quotidiana ben organizzata, nella quale la gestione ottimale degli strumenti consente di ridurre le perdite di tempo e aumentare la sicurezza dei pazienti. Asa Dental produce vassoi e box che permettono di spostare, sterilizzare e riporre opportunamente tutti gli strumenti che fanno della pratica dei professionisti un supporto irrinunciabile, che si tratti di risolvere problemi estetici o funzionali. Disponibili in diverse misure, forme e materiali, tutti i vassoi dispongono di un vasto set di accessori adatti a suddividere lo spazio interno e bloccare con sicurezza gli strumenti, proteggendo le parti più delicate e i rivestimenti durante le fasi di sterilizzazione.

J2	Cassette in acciaio
J4	Vassoi in acciaio
J8	Vassoi in alluminio
J12	Griglie portastrumenti in alluminio
J14	Lubrificanti per la protezione degli strumenti in autoclave
J15	Pinze per sterilizzazione
J16	Contenitori per endodonzia
J18	Accessori per endodonzia
J19	Porta frese
J20	Accessori

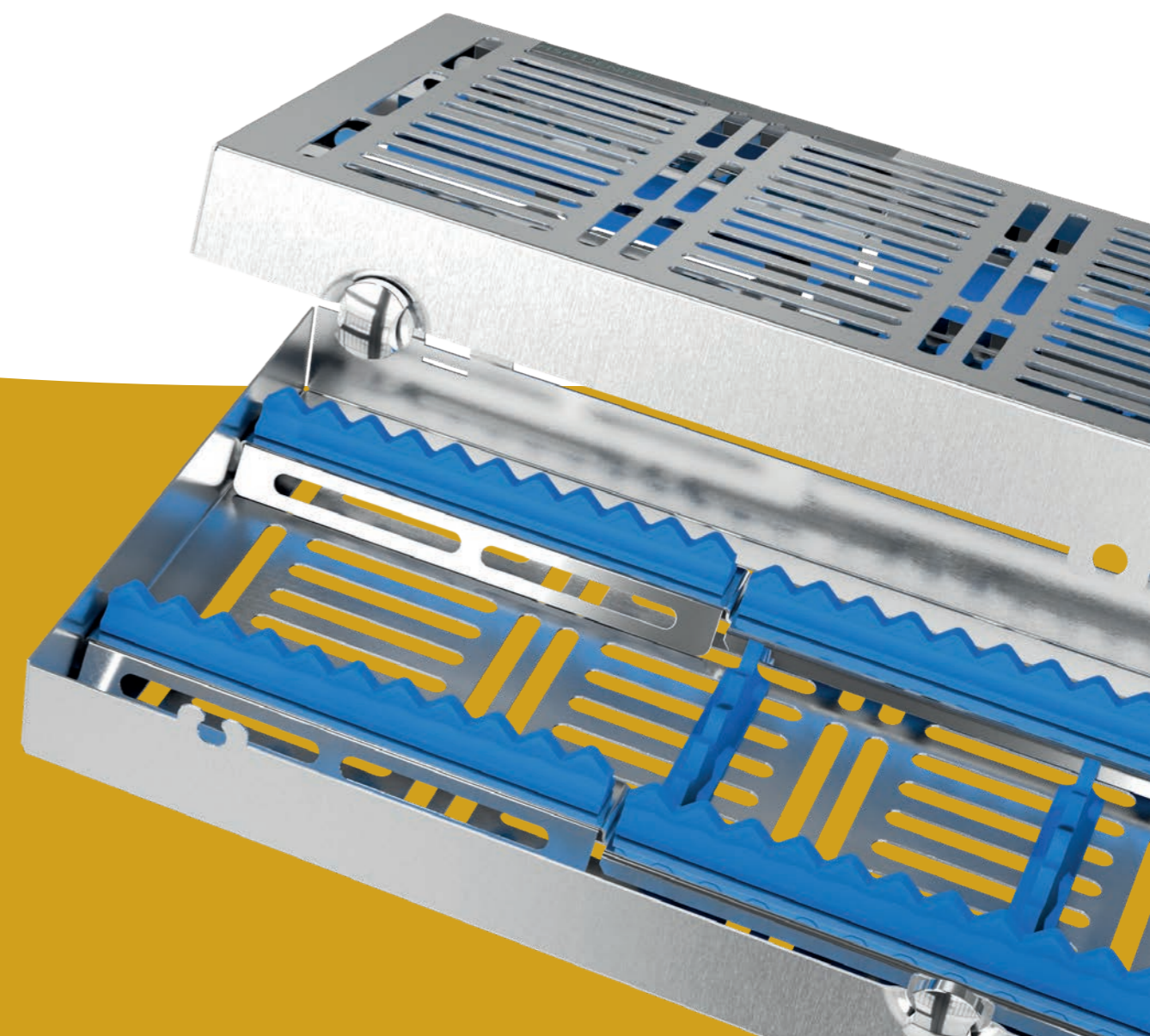

CASSETTE PORTASTRUMENTI IN ACCIAIO INOX

LARGE

288x182x34 mm

Completo di rastrelliera in silicone da **20 strumenti**

Blu
2770-1

Arancio
2770-1A

Rosso
2770-1R

Verde
2770-1V

Lilla, Giallo, Verde
2770-1MX



288x182x34 mm

Completo di rastrelliera in silicone da **15 strumenti**

Blu
2770-2

Arancio
2770-2A

Rosso
2770-2R

Verde
2770-2V

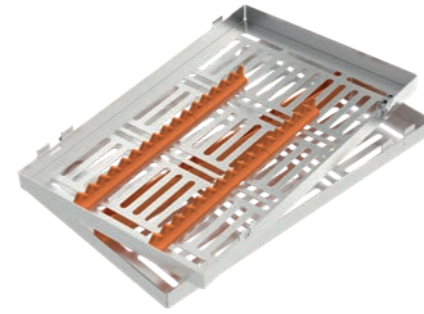

288x182x34 mm

Completo di rastrelliera in silicone da **10 strumenti**

Blu
2770-3

Arancio
2770-3A

Rosso
2770-3R

Verde
2770-3V



288x182x60 mm

Completo di rastrelliera in silicone da **20 strumenti**

Arancio
2780-1A

Blu
2780-1B

Rosso
2780-1R

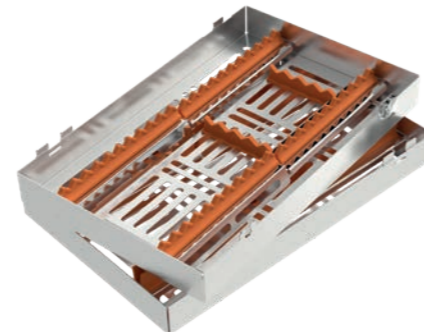

MEDIUM

182x144x34 mm

Completo di rastrelliera in silicone da **10 strumenti**

Blu
2771-1

Arancio
2771-1A

Rosso
2771-1R

Verde
2771-1V

Lilla
2771-1L

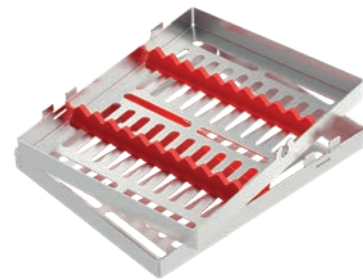

182x144x34 mm

Completo di rastrelliera in silicone da **5 strumenti**

Blu
2771-2

Arancio
2771-2A

Rosso
2771-2R

Verde
2771-2V



CASSETTE PORTASTRUMENTI IN ACCIAIO INOX

MINI

182x72x34 mm

Completo di rastrelliera in silicone da **5 strumenti**

Blu
2772-1

Arancio
2772-1A

Rosso
2772-1R

Verde
2772-1V

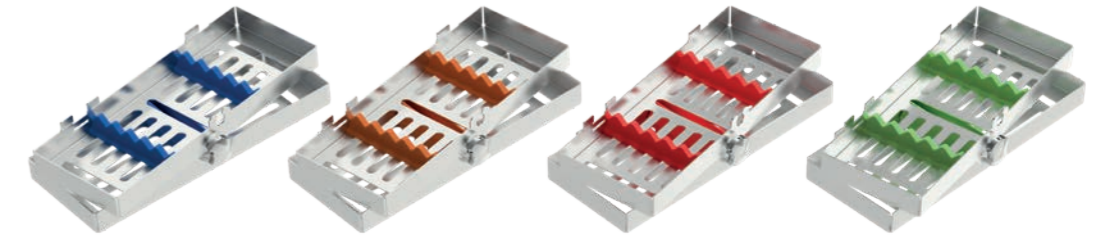

Blocca strumenti in silicone da **10 posti**

Blu
2770-G

Arancio
2770-GA

Rosso
2770-GR

Verde
2770-GV

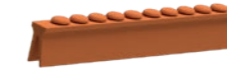

Blocca strumenti in silicone da **5 posti**

Blu
2771-G

Arancio
2771-GA

Rosso
2771-GR

Verde
2771-GV

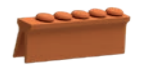

Rastrelliera in silicone da **10 posti**

Blu
2772-G

Arancio
2772-GA

Rosso
2772-GR

Verde
2772-GV



Rastrelliera in silicone da **5 posti**

Blu
2773-G

Arancio
2773-GA

Rosso
2773-GR

Verde
2773-GV



Serie di 2 pomelli di ricambio in acciaio completi di rondelle



2774

N° 2 clips per Locking Trays, per forbici

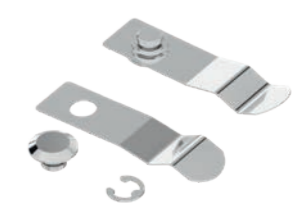

2775

VASSOI PORTASTRUMENTI IN ACCIAIO INOX

LARGE

288x187x39 mm

Vassoio completo di base forata,
coperchio forato e griglia per

per 16 strumenti
S2722-1

Vassoio completo di base forata,
coperchio forato e griglia per

per 23 strumenti
S2722-2

Coperchio forato
288x187x29 mm

2721-U

Base vassoio forata
284x183x17 mm

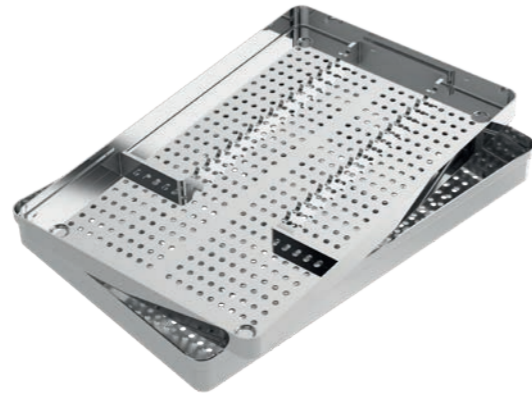
2721-L

Vassoio completo di base forata,
coperchio non forato e griglia

per 16 strumenti
S2721-1

Vassoio completo di base forata,
coperchio non forato e griglia

per 23 strumenti
S2721-2

Coperchio non forato
288x187x29 mm

2720-U

Base vassoio forata
284 x 183 x 17 mm

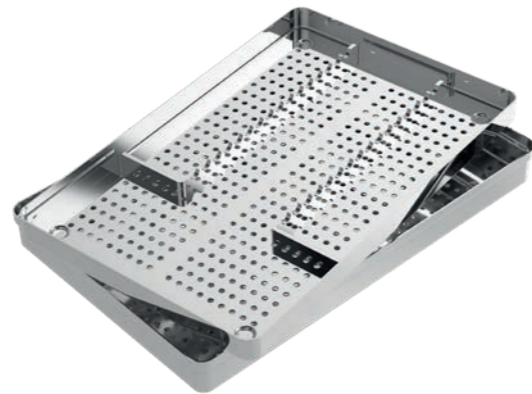
2721-L

VASSOI PORTASTRUMENTI IN ACCIAIO INOX

LARGE

288x187x39 mm

Vassoio completo di base non forata,
coperchio non forato e griglia

per 16 strumenti
S2720-1

Vassoio completo di base non forata,
coperchio non forato e griglia

per 23 strumenti
S2720-2

Coperchio non forato
288x187x29 mm

2720-U

Base vassoio non forata
284x183x17 mm

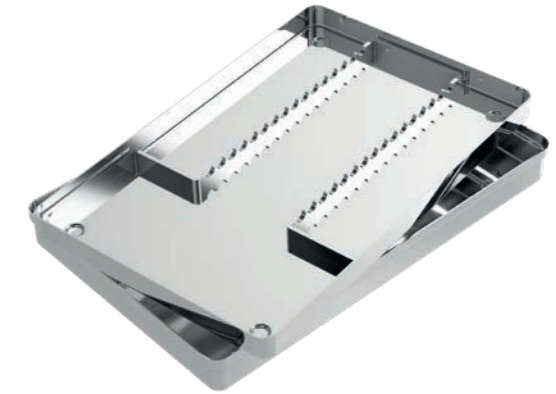
2720-L

Griglia portastrumenti
in acciaio inox

per 16 strumenti
2730-1

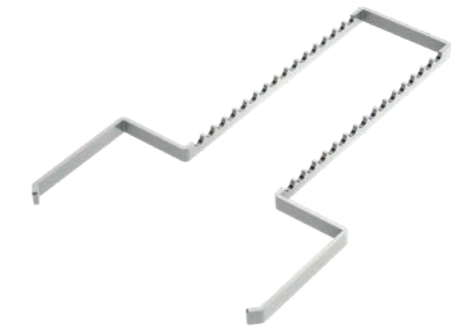

Griglia portastrumenti
in acciaio inox

per 23 strumenti
2730-2



VASSOI PORTASTRUMENTI IN ACCIAIO INOX

MEDIUM

200x100x30 mm

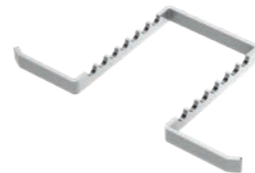
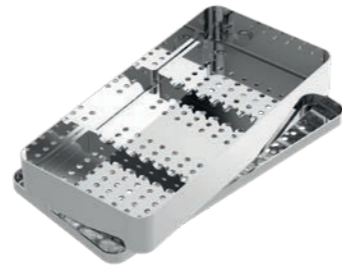
Vassoio completo di base forata,
coperchio forato e griglia**per 7 strumenti**
S2702Coperchio forato
200x100x10 mm**2702-U**Base vassoio forata
200x100x30 mm**2702-L**Vassoio completo di base non forata,
coperchio non forato e griglia**per 7 strumenti**
S2700Coperchio non forato
200x100x10 mm**2700-U**Base vassoio non forata
200x100x30 mm**2700-L**Griglia portastrumenti
in acciaio inox**per 7 strumenti**
2700-G**MEDIUM**

187x144x39 mm

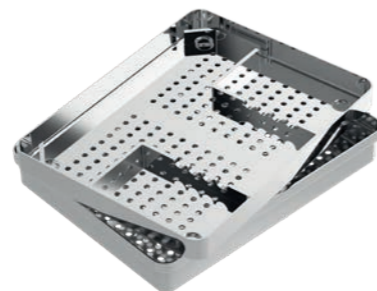
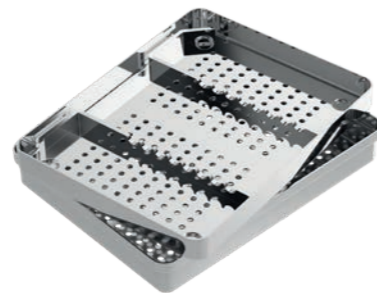
Vassoio completo di base forata,
coperchio forato e griglia**per 8 strumenti**
S2723-1Vassoio completo di base forata,
coperchio forato e griglia**per 4 strumenti**
S2723-2Coperchio forato
187x144x29 mm**2723-U**Base vassoio forata
183x142x17 mm**2723-L**

VASSOI PORTASTRUMENTI IN ACCIAIO INOX

MEDIUM

187x144x39 mm

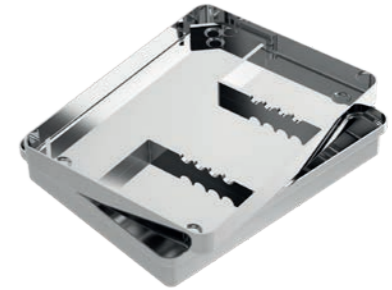
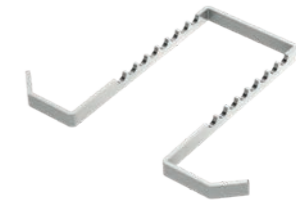
Vassoio completo di base non forata,
coperchio non forato e griglia**per 8 strumenti**
S2724-1Vassoio completo di base non forata,
coperchio non forato e griglia**per 4 strumenti**
S2724-2Coperchio non forato
187x144x29 mm**2724-U**Base vassoio non forata
183x142x17 mm**2724-L**Griglia portastrumenti
in acciaio inox**per 8 strumenti**
2730-4Griglia portastrumenti
in acciaio inox**per 4 strumenti**
2730-5

VASSOI PORTASTRUMENTI IN ALLUMINIO ANODIZZATO COLORATO

LARGE
284x183x17 mm

Azzurro
AL2720-LC

Rosso
AL2720-LR

Oro
AL2720-LO

Verde
AL2720-LV

Argento
AL2720-LA

Coperchio
288x187x29 mm

Argento
AL2720-UA

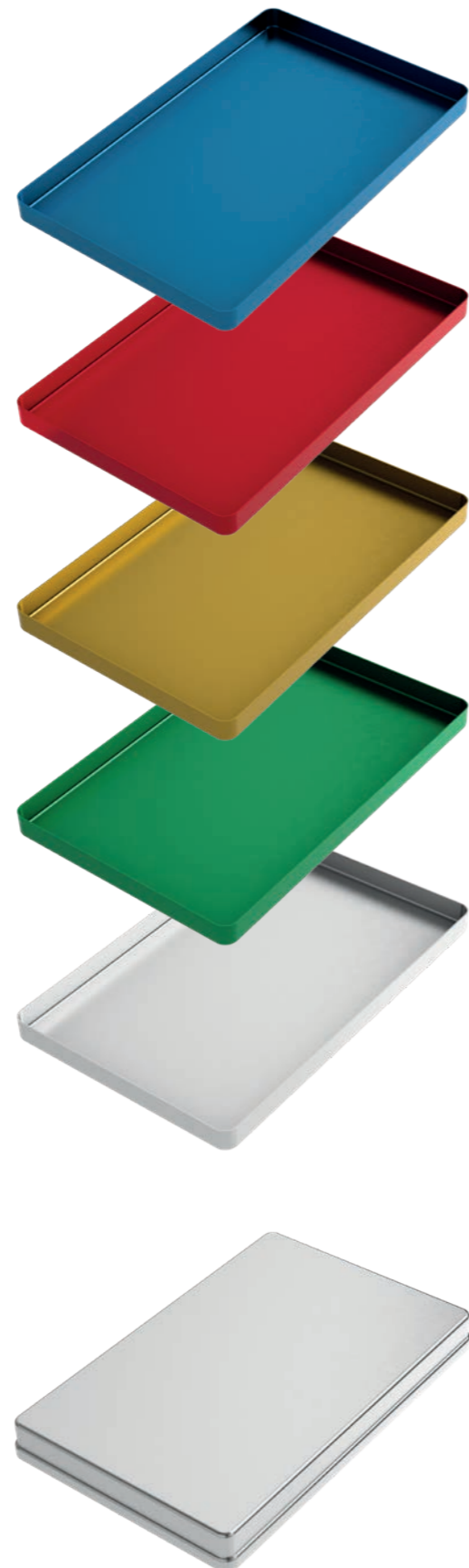

VASSOI PORTASTRUMENTI IN ALLUMINIO ANODIZZATO COLORATO - FORATI

LARGE
284x183x17 mm

Azzurro
AL2721-LC

Rosso
AL2721-LR

Oro
AL2721-LO

Verde
AL2721-LV

Argento
AL2721-LA

Coperchio
288x187x29 mm

Argento
AL2721-UA

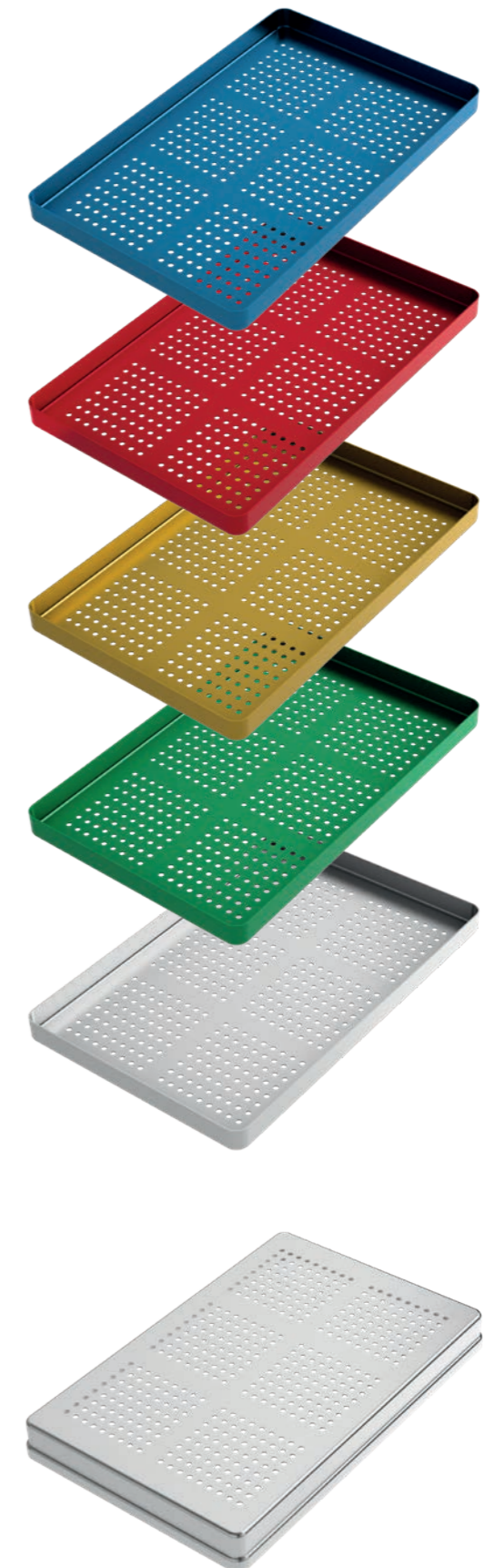

VASSOI PORTASTRUMENTI IN ALLUMINIO ANODIZZATO COLORATO

MEDIUM
142x183x17 mm

Azzurro
AL2722-LC

Rosso
AL2722-LR

Oro
AL2722-LO

Verde
AL2722-LV

Argento
AL2722-LA



Coperchio
144x187x29 mm

Argento
AL2722-UA



VASSOI PORTASTRUMENTI IN ALLUMINIO ANODIZZATO COLORATO

MINI
100x180x11 mm

Azzurro
AL2723-LC

Rosso
AL2723-LR

Oro
AL2723-LO

Verde
AL2723-LV

Argento
AL2723-LA

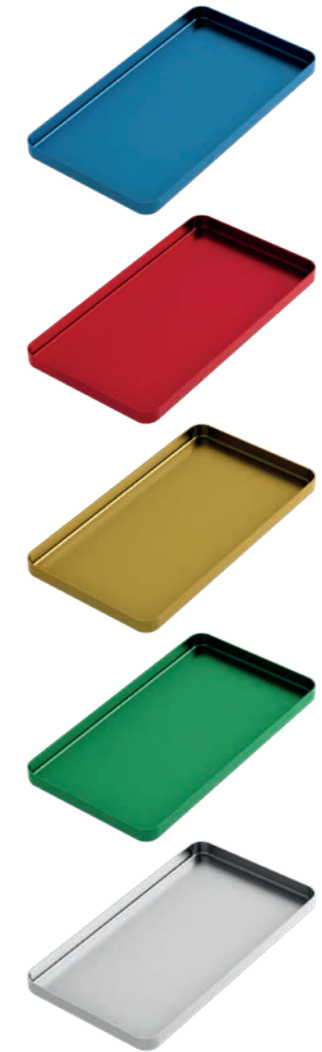

Coperchio
103x182x10 mm

Argento
AL2723-UA



GRIGLIE PORTASTRUMENTI IN ALLUMINIO

GRIGLIE PORTASTRUMENTI IN ALLUMINIO

Compatibili esclusivamente con i vassoi AL2722

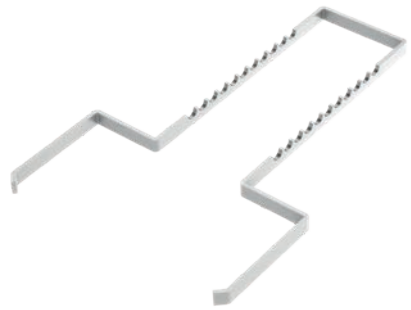

per 11 strumenti
AL2730-1

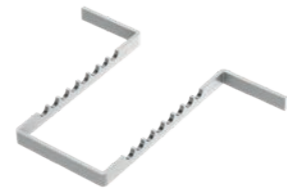

per 8 strumenti
AL2731-1

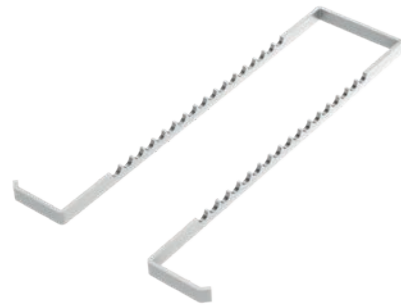

per 17 strumenti
AL2730-2

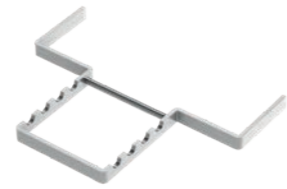

per 4 strumenti
AL2731-2

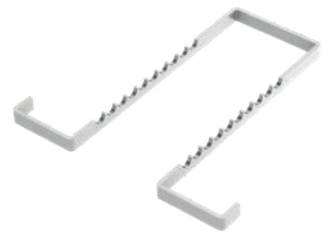

per 10 strumenti
AL2730-3

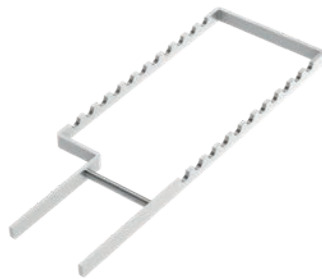

per 11 strumenti
AL2730-4



AL2722-LA
vassoi in alluminio
per protocollo
operativo



VASSOI IN ACCIAIO INOX

MAXI
200x150 mm



2737-1



2737-2

Bacinella inox reniforme



2737-3
170x100x35 mm



2737-4
250x140x40 mm

VASSOIO PORTA PINZE

STANDARD
Vassoio in acciaio inox porta pinze



S5800

LUBRIFICANTI PER LA PROTEZIONE DEGLI STRUMENTI IN AUTOCLAVE

Massima protezione degli strumenti in autoclave. Penetra negli snodi e lubrifica. Protegge e lubrifica gli strumenti chirurgici e dentali prima e dopo la sterilizzazione.

Modalità d'uso:
oliare prima e dopo la sterilizzazione le punte, gli snodi e le chiusure degli strumenti.



Steril Oil
40 ml
8002

Lubrificante speciale per strumenti dentali e chirurgici. Per lubrificare gli snodi di forbici, pinze per estrazione, ossivore, emostatiche, porta aghi ecc. prima e dopo la sterilizzazione. Non viene assorbito durante la sterilizzazione. Protegge dalla corrosione e da altri depositi e cura il buon funzionamento degli strumenti.



Silicone
40 ml
8010

BACINELLE IN ALLUMINIO ANODIZZATO PER VASSOI PORTASTRUMENTI



AL2724-1
49x26x10 mm



AL2724-2
49x26x10 mm



AL2724-3
59x49x10 mm



AL2724-4
59x49x10 mm

PORTA VASSOI IN ALLUMINIO

STANDARD
300x190x270 mm



6 ripiani
AL2739-1

MEDIUM
160x190x270 mm



6 ripiani
AL2739-2

PINZE PER STERILIZZAZIONE

20 cm
0565-1



30 cm
0565-2



CONTENITORI PER ENDODONZIA

Contenitori per endodonzia in alluminio anodizzato completi di coperchio

MAXI

204x105x54 mm



AL2740-1



AL2740-2



AL2740-3

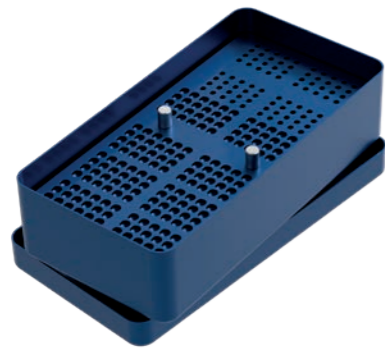

AL2740-4



AL2740-5

MEDIUM

125x105x54 mm



AL2741-1

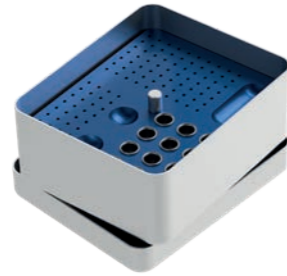

AL2741-2

Bicchierini di ricambio per endo-box



AL2740-R

CONTENITORI PER ENDODONZIA

Contenitori per endodonzia in alluminio anodizzato completi di coperchio

MINI

100x44x54 mm



AL2742-1



AL2742-2



AL2742-3



AL2742-4



AL2742-5



AL2742-6



AL2742-7

Contenitori per endodonzia rotondi

in alluminio anodizzato completi di coperchio



AL2744
Ø 48 mm - h. 62 mm



AL2743
Ø 94 mm - h. 70 mm



AL2740-R

Bicchierini di ricambio per endo-box

ACCESSORI PER ENDODONZIA

Vassoio per endodonzia in alluminio

completo di coperchio
257x116x16 mm



AL2725

Pulitori per strumenti canalari in alluminio anodizzato

Ø 40 mm - h. 30 mm



AL2746-1



AL2746-2

Misuratori per strumenti canalari in alluminio anodizzato

100x40x40 mm

Ø 34 mm - h. 48 mm

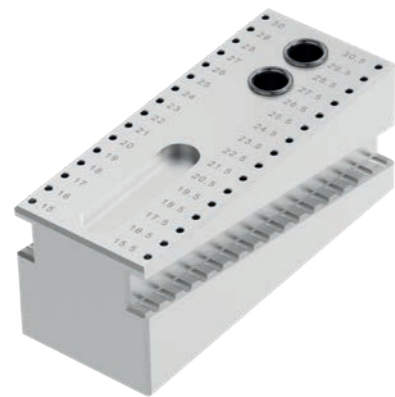

AL2747-1A



AL2745-1A



AL2745-2C

PORTA FRESE



con 7 porta frese, con coperchio
AL2763-1



con 2 porta frese
AL2763-2

Autoclavabili

Silicone alimentare atossico. Il coperchio in plastica non è autoclavabile.

- Inserimento di frese da turbina e da micromotore in un unico porta frese.
- Set operativi differenziati per colore, ottimizzando tempi di intervento, stoccaggio e scelta.
- Fori a croce nei porta frese in silicone bloccano la fuoriuscita, prevenendo cadute e rotture.

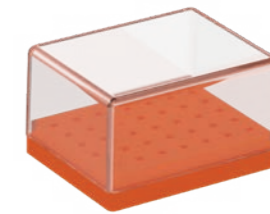

Arancio
S2760-A

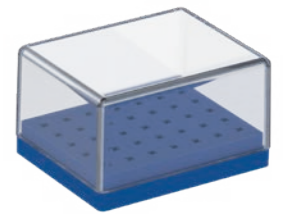

Blu
S2760-C

Alluminio

Sterilizzabile in autoclave a vapore saturo

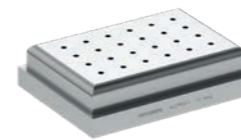

con bordo, 24 fori FG
AL2760-1
(frese piccole)



con bordo, 24 fori CA
AL2760-2
(frese grandi)

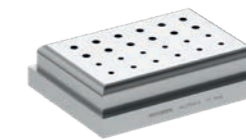

con bordo, 24 fori FG/CA
AL2760-3
(frese piccole e grandi)



AL2760-U
coperchio

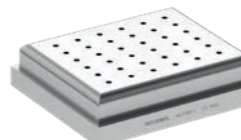

con bordo, 36 fori FG
AL2761-1
(frese piccole)



con bordo, 36 fori CA
AL2761-2
(frese grandi)

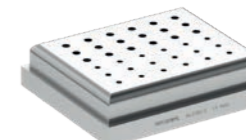

con bordo, 36 fori FG/CA
AL2761-3
(frese piccole e grandi)



AL2761-U
coperchio per AL2761-1, 2, 3
e per porta frese in silicone



48 fori FG
AL2762-1
(frese piccole)



48 fori CA
AL2762-2
(frese grandi)



48 fori FG/CA
AL2762-3
(frese piccole e grandi)

ACCESSORI

Portarifiuti in alluminio anodizzato

sterilizzabili
disponibili in 5 colori
Ø 7 x h. 7,5 cm



AL2764-A

AL2764-C

AL2764-O

AL2764-R

AL2764-V

Distributori di cotone in alluminio anodizzato

con molla interna
sterilizzabili
disponibili in 5 colori
Ø 7 x h. 7,5 cm

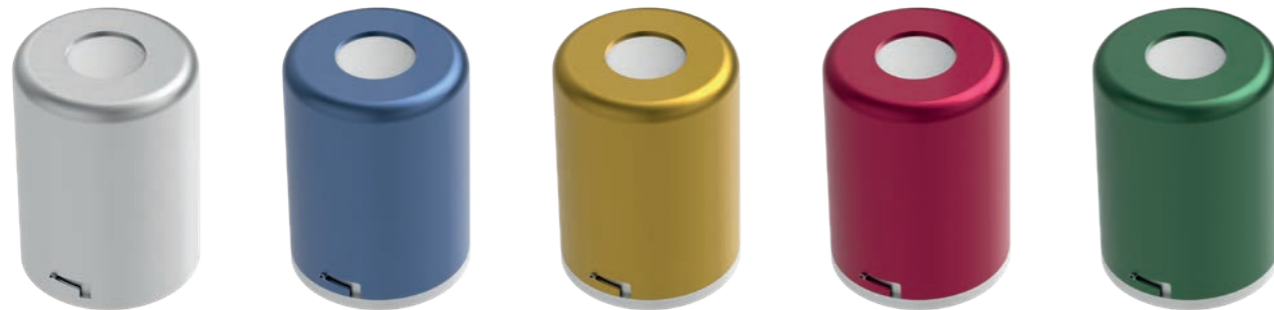

AL2765-A

AL2765-C

AL2765-O

AL2765-R

AL2765-V

Portarifiuti monouso

1000 pz / confezione



AL2767-1

Supporto in alluminio

per portarifiuti



AL2767-2

ACCESSORI

Contenitore in plastica per aghi usati

AL2766

Distributore di palline di cotone in acciaio inox
40x40x50 mm

2751-1

Lampada ad alcool in acciaio inox con stoppino

3101

Stoppino di ricambio

15 cm



3101-1

PORTAIMPRONTE

MADE IN ITALY

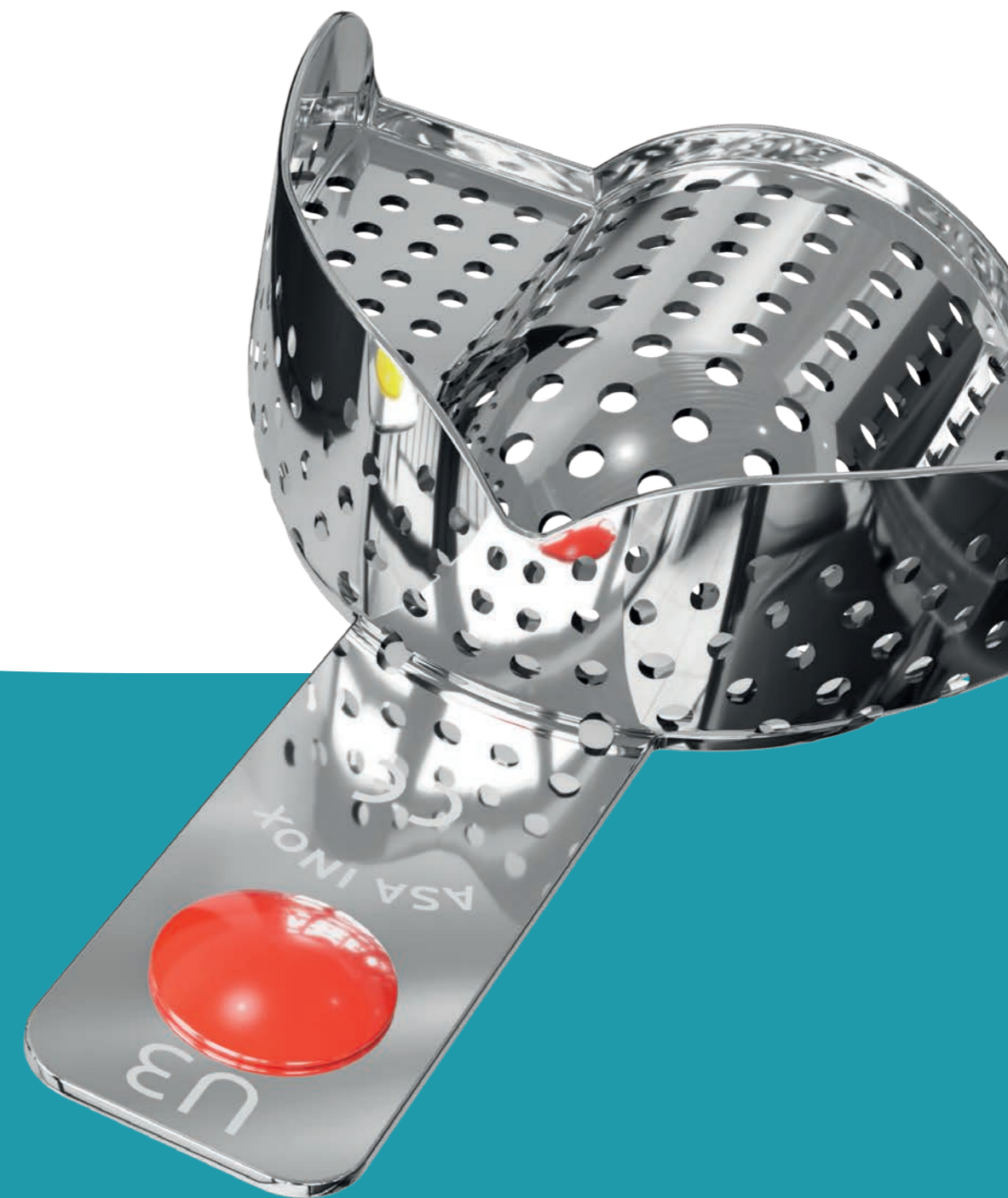
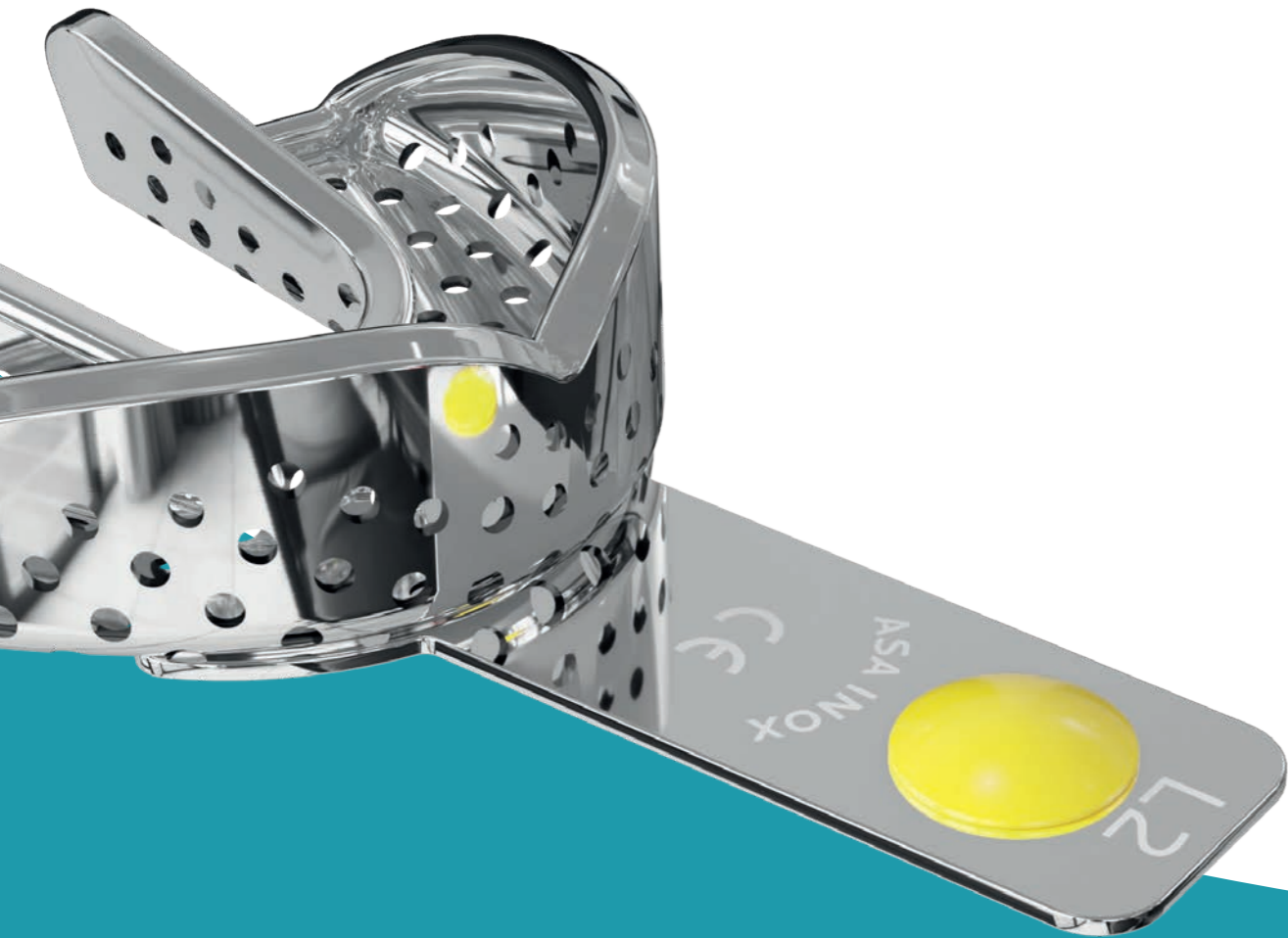

K4	Forati in acciaio
K22	Non forati in acciaio
K38	Forati in alluminio
K44	Occlusali parziali
K45	Per bambini in alluminio
K46	In policarbonato

AD OGNUNO LA SUA FORMA

Rilevare l'impronta delle arcate del paziente in maniera corretta è di primaria importanza per poter ottenere un risultato ottimale fin da subito.

Scegliere una dimensione sbagliata o una forma non adatta, porta di solito ad un'impronta inadeguata: interventi di terapia conservativa e protesi possono in tal modo dare origine a problemi di scarsa o mal occlusione e richiedere costi e tempi più elevati.

I portaimpronte Asa Dental sono disponibili in diverse forme e materiali, dispongono di un pratico sistema colorimetrico che rende immediata l'individuazione della misura, e garantiscono tutta la necessaria precisione indispensabile per ottenere un risultato perfetto.

ELEMENTI

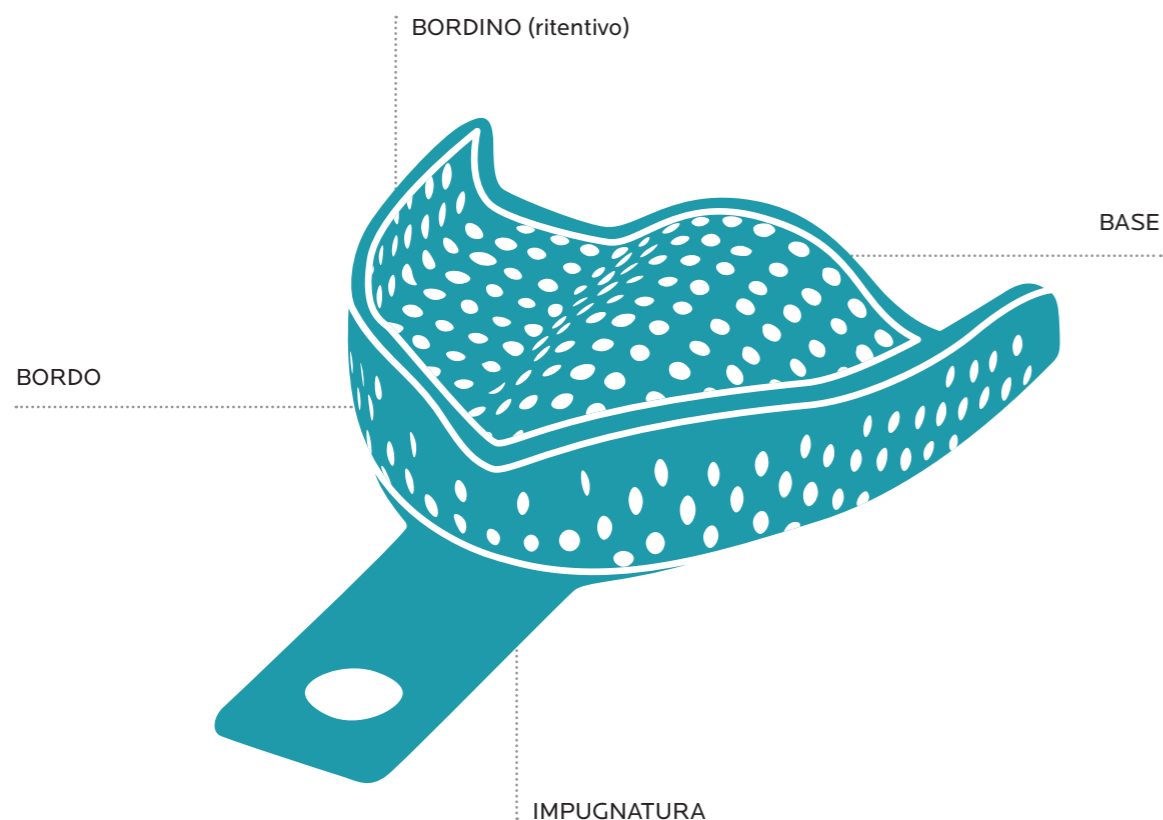

INDICE DEI COLORI

ASA Codicolor

- U1/L1
XXS
- U2/L2
XS
- U3/L3
S
- U4/L4
M
- U5/L5
L
- U6/L6
XL



TABELLA DI SELEZIONE

Materiali	Tecnica					
	Monofasica a 2 materiali	Monofasica a 1 materiale	Bifasica	Impronta bordata	Impronta parziale	Sandwich
Silicone	2802 2803 2807	2880	2800 2801 2804 2804S 2808 2809 2811 2813 2814 2806		2819	2819 2803S
Alginate	2804S 2813	2851 2852 2804 2801 2800 2814	2806 2851	2851		
Polietere/ Polisolfuro	2802 2803 2807	2802 2803 2803S 2807 2810				2807S 2810

Legenda

2880: ideale
2807: compatibile

CLASSIFICAZIONE



STRUTTURA	DENTIZIONE	FORMA	MATERIALE
forato non forato	edentuli dentuli	completo parziale	acciaio inox alluminio policarbonato

PORTAIMPRONTE FORATI IN ACCIAIO INOX - PERMA-LOCK

con bordino ritentivo



ASA Codicolor

-  U1/L1
XXS
-  U2/L2
XS
-  U3/L3
S
-  U4/L4
M
-  U5/L5
L
-  U6/L6
XL

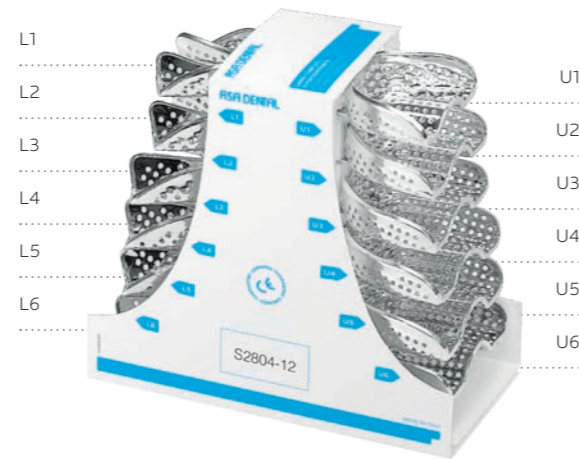

S2804-12
set da 12



S2804-8
set da 8



S2804-6
set da 6

PORTAIMPRONTE FORATI IN ACCIAIO INOX - PERMA-LOCK

con bordino ritentivo

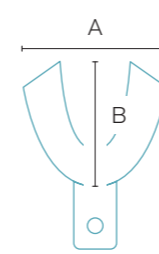

2804 Inferiore

		A (mm)	B (mm)
L1	XXS	55	47
L2	XS	60	49
L3	S	72	54
L4	M	74	57
L5	L	76	59
L6	XL	78	61

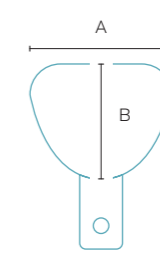

2804 Superiore

		A (mm)	B (mm)
U1	XXS	61	47
U2	XS	64	51
U3	S	66	53
U4	M	69	57
U5	L	71	60
U6	XL	73	62

Inferiore



2804-L1



2804-L2



2804-L3



2804-L4



2804-L5



2804-L6

Superiore



2804-U1



2804-U2



2804-U3



2804-U4



2804-U5



2804-U6

Parziale



2804-L1P



2804-L2D



2804-L3D



2804-L4D



2804-L5D



2804-L6D

Parziale



2804-U1P



2804-L2S



2804-U3S



2804-L4S



2804-U5S









2804-L6S

PORTAIMPRONTE FORATI IN ACCIAIO INOX - PERMA-LOCK ANATOMIC
con bordino ritentivo



ASA Codicolor

-  U1/L1
XXS
-  U2/L2
XS
-  U3/L3
S
-  U4/L4
M
-  U5/L5
L
-  U6/L6
XL

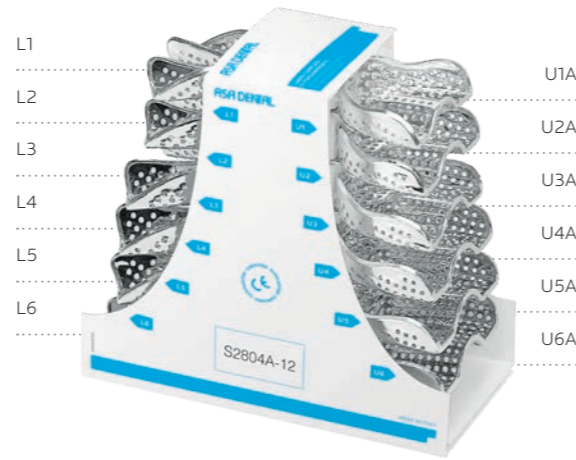

S2804A-12
set da 12



S2804A-8
set da 8



S2804A-6
set da 6

PORTAIMPRONTE FORATI IN ACCIAIO INOX - PERMA-LOCK ANATOMIC
con bordino ritentivo

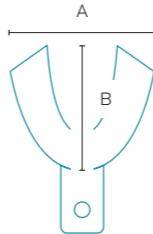
		A (mm)		B (mm)	
	L1	XXS	55	47	
	L2	XS	60	49	
	L3	S	72	54	
	L4	M	74	57	
	L5	L	76	59	
	L6	XL	78	61	

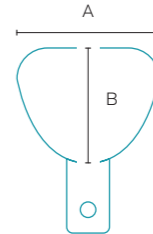
		A (mm)		B (mm)	
	U1A	XXS	61	47	
	U2A	XS	64	51	
	U3A	S	66	53	
	U4A	M	69	57	
	U5A	L	71	60	
	U6A	XL	73	62	

Inferiore



Superiore

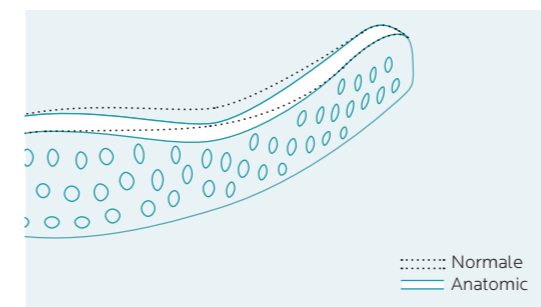

PORTAIMPRONTE FORATI IN ACCIAIO INOX - PERMA-LOCK HIGH GRIP

con bordino ritentivo maggiorato e superficie interna microritentiva



S2804S-12
set da 12



S2804S-8
set da 8



S2804S-6
set da 6

PORTAIMPRONTE FORATI IN ACCIAIO INOX - PERMA-LOCK HIGH GRIP

con bordino ritentivo maggiorato e superficie interna microritentiva

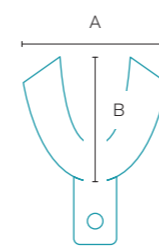

2804S Inferiore

		A (mm)	B (mm)
L1	XXS	55	47
L2	XS	60	49
L3	S	72	54
L4	M	74	57
L5	L	76	59
L6	XL	78	61

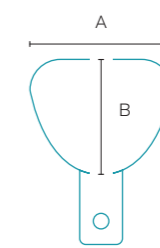

2804S Superiore

		A (mm)	B (mm)
U1	XXS	61	47
U2	XS	64	51
U3	S	66	53
U4	M	69	57
U5	L	71	60
U6	XL	73	62

Inferiore



Superiore

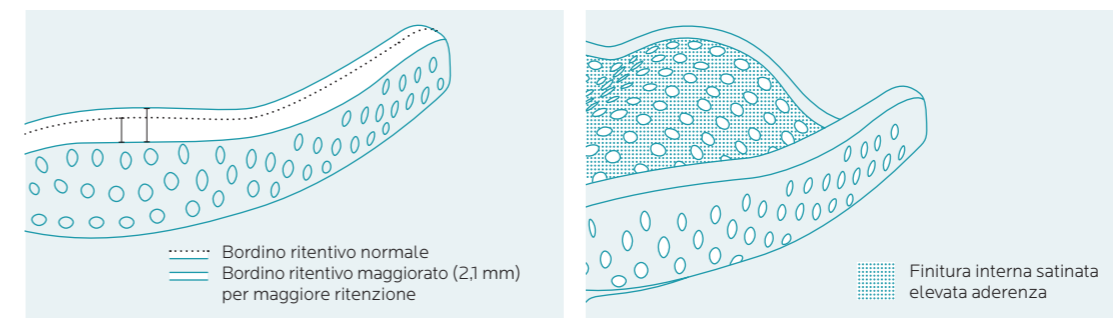

PORTAIMPRONTE FORATI IN ACCIAIO INOX - DEPRESSI ANTERIORMENTE

con bordino ritentivo



2809 Inferiore

		A (mm)	B (mm)
L22	S	76	54
L21	M	79	57
L20	L	81	60

2809 Superiore

		A (mm)	B (mm)
U7	S	70	57
U4	M	71	64
U1	L	81	67

Inferiore



Superiore



S2809-6
set da 6

PORTAIMPRONTE FORATI IN ACCIAIO INOX - EDENTULI

con bordino ritentivo



2806 Inferiore

		A (mm)	B (mm)
L69	S	70	57
L68	M	73	60
L67	NL	70	64
L66	L	86	64

NL: Narrow Large (large stretta)

2806 Superiore

		A (mm)	B (mm)
U64	S	73	60
U63	NM	70	64
U62	M	76	67
U61	L	79	70

NM: Narrow Medium (medium stretta)

Inferiore



Superiore



S2806-8
set da 8

PORTAIMPRONTE FORATI IN ACCIAIO INOX

senza bordino ritentivo

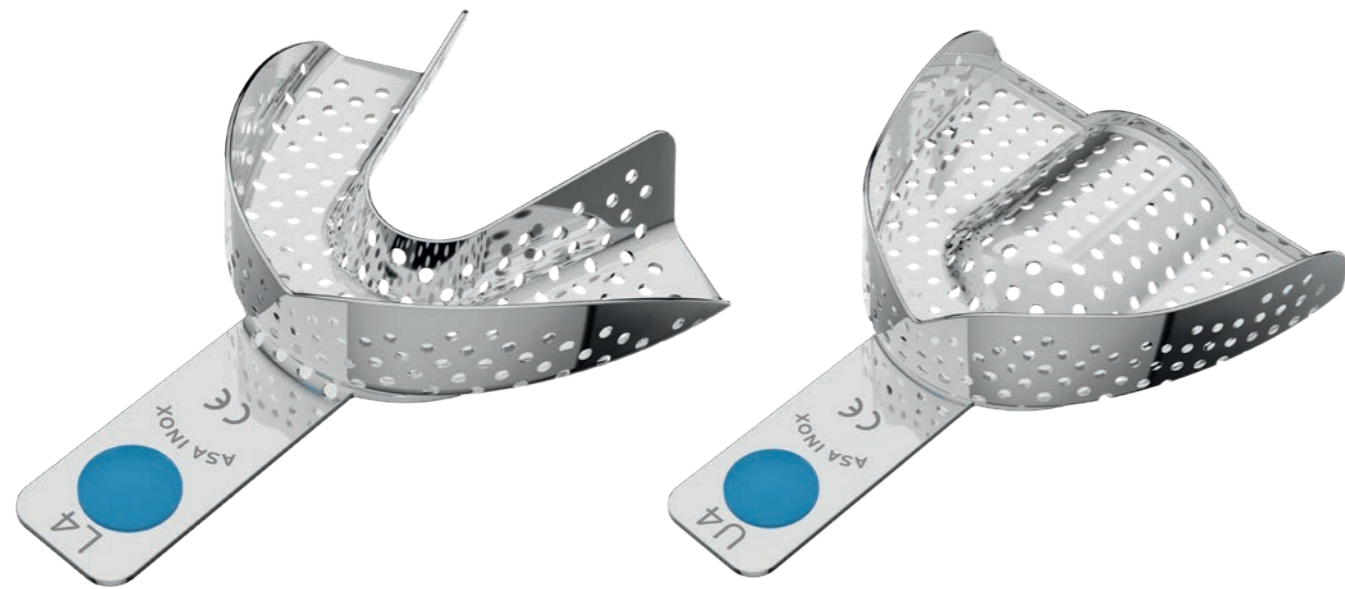

ASA Codicolor

- U1/L1
XXS
- U2/L2
XS
- U3/L3
S
- U4/L4
M
- U5/L5
L
- U6/L6
XL

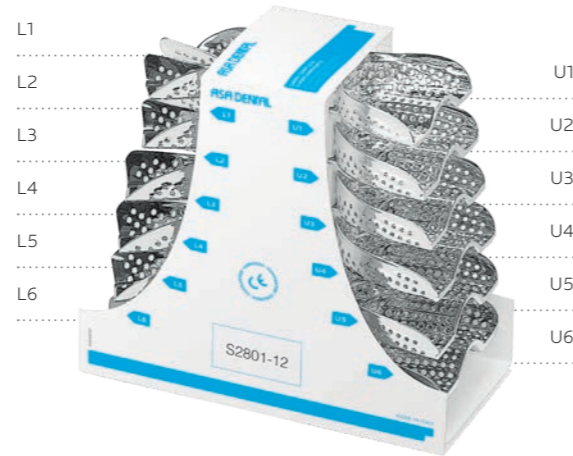

S2801-12
set da 12



S2801-8
set da 8



S2801-6
set da 6

PORTAIMPRONTE FORATI IN ACCIAIO INOX

senza bordino ritentivo

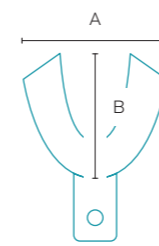

2801 Inferiore

		A (mm)	B (mm)
L1	XXS	55	47
L2	XS	60	49
L3	S	72	54
L4	M	74	57
L5	L	76	59
L6	XL	78	61

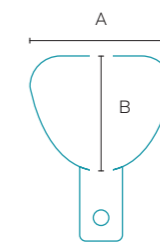

2801 Superiore

		A (mm)	B (mm)
U1	XXS	61	47
U2	XS	64	51
U3	S	66	53
U4	M	69	57
U5	L	71	60
U6	XL	73	62

Inferiore



2801-L1



2801-L2



2801-L3



2801-L4



2801-L5



2801-L6

Superiore



2801-U1



2801-U2



2801-U3



2801-U4



2801-U5



2801-U6

Parziale



2801-L2D



2801-L4D



2801-L6D

Parziale



2801-L2S



2801-L4S



2801-L6S

PORTAIMPRONTE FORATI IN ACCIAIO INOX - ANATOMIC

senza bordino ritentivo



ASA Codicolor

- U1/L1
XXS
- U2/L2
XS
- U3/L3
S
- U4/L4
M
- U5/L5
L
- U6/L6
XL



S2801A-12
set da 12



S2801A-8
set da 8



S2801A-6
set da 6

PORTAIMPRONTE FORATI IN ACCIAIO INOX - ANATOMIC

senza bordino ritentivo

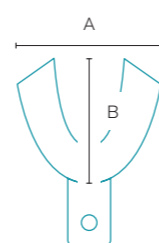

2801 Inferiore

		A (mm)	B (mm)
L1	XXS	55	47
L2	XS	60	49
L3	S	72	54
L4	M	74	57
L5	L	76	59
L6	XL	78	61

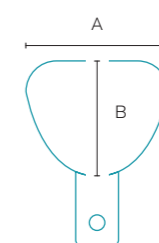

2801 Superiore

		A (mm)	B (mm)
U1	XXS	61	47
U2	XS	64	51
U3	S	66	53
U4	M	69	57
U5	L	71	60
U6	XL	73	62

Inferiore



Superiore

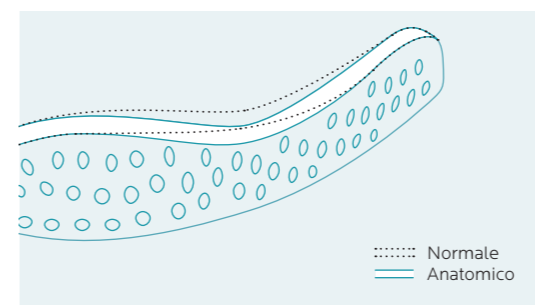

PORTAIMPRONTE FORATI IN ACCIAIO INOX - EHRICKE

senza bordino ritentivo



2811-UB Inferiore

	A (mm)	B (mm)
2811-UB0	65	46
2811-UB1	67	50
2811-UB2	76	54
2811-UB3	79	56
2811-UB4	79	61

per arcate inferiori, per bambini

2811-OB Superiore

	A (mm)	B (mm)
2811-OB0	59	52
2811-OB1	66	52
2811-OB2	71	62
2811-OB3	71	64
2811-OB4	80	70

per arcate superiori, per bambini



S2811-1
set da 10



S2811-2
set da 6

PORTAIMPRONTE FORATI IN ACCIAIO INOX - EHRICKE

senza bordino ritentivo

Inferiore



Superiore



2811-BS Superiore

	A (mm)	B (mm)
2811-BS2	70	54

per arcate superiori strette



2811-BS2

PORTAIMPRONTE FORATI IN ACCIAIO INOX - EHRICKE

senza bordino ritentivo



2811-UU Inferiore

	A (mm)	B (mm)
2811-UU1	70	48
2811-UU2	70	53
2811-UU3	72	57

per arcate inferiori edentule

2811-OU Superiore

	A (mm)	B (mm)
2811-OU1	64	46
2811-OU2	68	53
2811-OU3	79	61

per arcate superiori edentule

PORTAIMPRONTE FORATI IN ACCIAIO INOX - EHRICKE

senza bordino ritentivo



2811-UP Inferiore

	A (mm)	B (mm)
2811-UP1	70	55
2811-UP2	78	59

per arcate inferiori parzialmente dentate

2811-OP Superiore

	A (mm)	B (mm)
2811-OP1	62	50
2811-OP2	70	56

per arcate superiori parzialmente dentate

Inferiore

Superiore



S2811-3
set da 10

Inferiore

Superiore

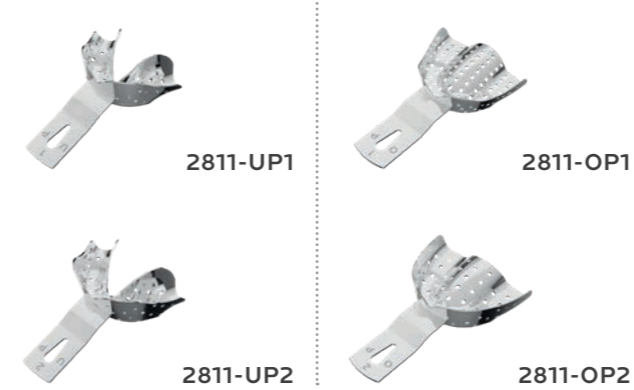

S2811-4
set da 8

PORTAIMPRONTE FORATI IN ACCIAIO INOX - EDENTULI

senza bordino ritentivo

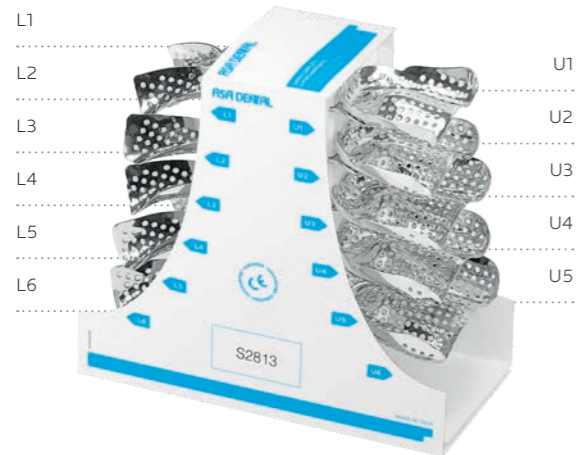

S2813
set da 11 pezzi
più compasso per
impronte definitive



MB026-1
compasso in acciaio inox

PORTAIMPRONTE FORATI IN ACCIAIO INOX - EDENTULI

senza bordino ritentivo

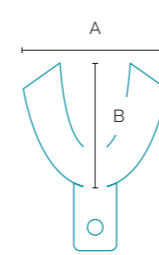

2813 Inferiore

		A (mm)	B (mm)
L1	XXS	60	54
L2	XS	67	55
L3	S	70	56
L4	M	74	58
L5	L	76	60
L6	XL	80	62

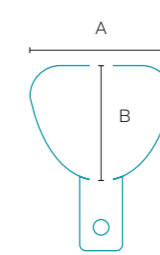

2813 Superiore

		A (mm)	B (mm)
U1	XXS	60	50
U2	XS	64	54
U3	S	68	58
U4	M	70	60
U5	L	78	64

Inferiore



2813-L1



2813-L2



2813-L3



2813-L4



2813-L5



2813-L6

Superiore



2813-U1



2813-U2



2813-U3



2813-U4



2813-U5

PORTAIMPRONTE NON FORATI IN ACCIAIO INOX - NEW SUPER

con bordino ritentivo



PORTAIMPRONTE NON FORATI IN ACCIAIO INOX - NEW SUPER

con bordino ritentivo

2803 Inferiore					2803 Superiore				
		A (mm)	B (mm)				A (mm)	B (mm)	
	L5	XS	69	50		U5	XS	65	51
	L4	S	72	57		U4	S	67	53
	L3	M	76	57		U3	M	71	55
	L2	L	78	59		U2	L	74	60
	L1	XL	80	63		U1	XL	81	63

Inferiore



Superiore



ASA Codicolor

- U5/L5
XXS
- U4/L4
XS
- U3/L3
S
- U2/L2
M
- U1/L1
L



S2803-10
set da 10

PORTAIMPRONTE NON FORATI IN ACCIAIO INOX - PERMA-LOCK
con bordino ritentivo



ASA Codicolor

- U1/L1
XXS
- U2/L2
XS
- U3/L3
S
- U4/L4
M
- U5/L5
L
- U6/L6
XL



S2807-12
set da 12



S2807-8
set da 8



S2807-6
set da 6

PORTAIMPRONTE NON FORATI IN ACCIAIO INOX - PERMA-LOCK
con bordino ritentivo

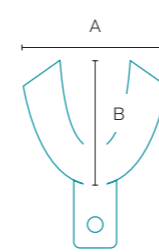

2807 Inferiore

		A (mm)	B (mm)
L1	XXS	55	47
L2	XS	60	49
L3	S	72	54
L4	M	74	57
L5	L	76	59
L6	XL	78	61

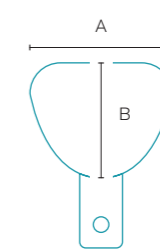

2807 Superiore

		A (mm)	B (mm)
U1	XXS	61	47
U2	XS	64	51
U3	S	66	53
U4	M	69	57
U5	L	71	60
U6	XL	73	62

Inferiore



2807-L1



2807-L2



2807-L3



2807-L4



2807-L5



2807-L6

Superiore



2807-U1



2807-U2



2807-U3



2807-U4



2807-U5



2807-U6

Parziale



2807-L1P



2807-L2D



2807-L4D



2807-L6D

Parziale



2807-U1P



2807-L2S



2807-L4S



2807-L6S



2807-L6S



2807-L6S

PORTAIMPRONTE NON FORATI IN ACCIAIO INOX - PERMA-LOCK ANATOMIC

con bordino ritentivo



ASA Codicolor

- U1/L1
XXS
- U2/L2
XS
- U3/L3
S
- U4/L4
M
- U5/L5
L
- U6/L6
XL



S2807A-12
set da 12



S2807A-8
set da 8



S2807A-6
set da 6

PORTAIMPRONTE NON FORATI IN ACCIAIO INOX - PERMA-LOCK ANATOMIC

con bordino ritentivo

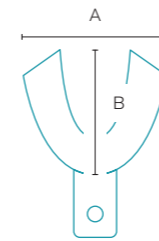

2807 Inferiore

		A (mm)	B (mm)
L1	XXS	55	47
L2	XS	60	49
L3	S	72	54
L4	M	74	57
L5	L	76	59
L6	XL	78	61

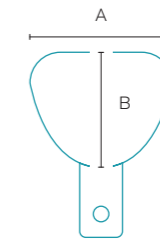

2807 Superiore

		A (mm)	B (mm)
U1A	XXS	61	47
U2A	XS	64	51
U3A	S	66	53
U4A	M	69	57
U5A	L	71	60
U6A	XL	73	62

Inferiore



Superiore

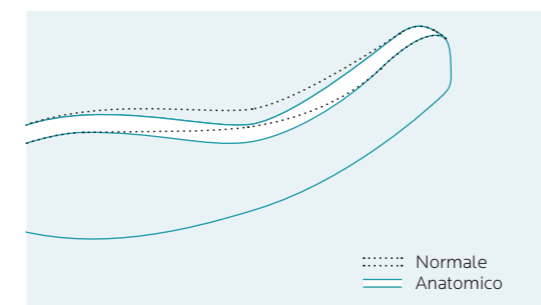

PORTAIMPRONTE NON FORATI IN ACCIAIO INOX - PERMA-LOCK HIGH GRIP

con bordino ritentivo maggiorato e superficie interna microritentiva



S2807S-12
set da 12



S2807S-8
set da 8



S2807S-6
set da 6

PORTAIMPRONTE NON FORATI IN ACCIAIO INOX - PERMA-LOCK HIGH GRIP

con bordino ritentivo maggiorato e superficie interna microritentiva

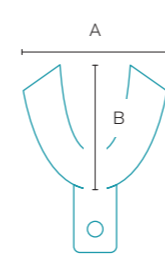

2807S Inferiore

		A (mm)	B (mm)
L1	XXS	55	47
L2	XS	60	49
L3	S	72	54
L4	M	75	57
L5	L	76	59
L6	XL	78	61

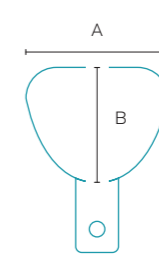

2807S Superiore

		A (mm)	B (mm)
U1	XXS	61	47
U2	XS	64	51
U3	S	66	53
U4	M	69	57
U5	L	71	60
U6	XL	73	62

Inferiore



2807S-L1



2807S-L2



2807S-L3



2807S-L4



2807S-L5



2807S-L6

Superiore



2807S-U1



2807S-U2



2807S-U3



2807S-U4



2807S-U5



2807S-U6

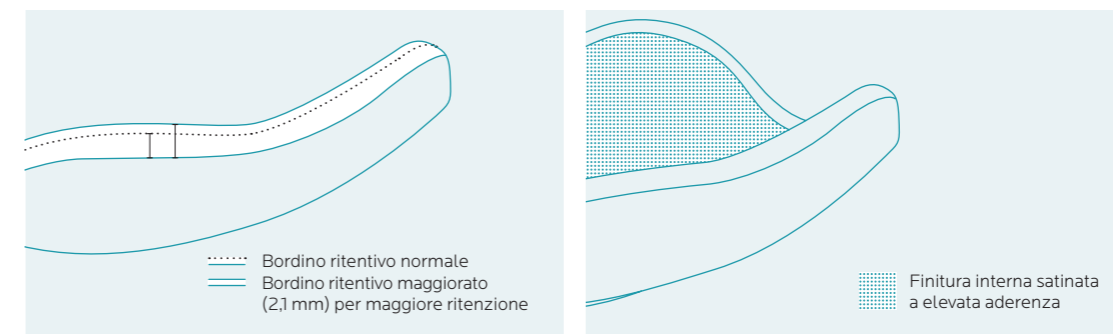

PORTAIMPRONTE NON FORATI IN ACCIAIO INOX - DEPRESSI ANTERIORMENTE

con bordino ritentivo



2810 Inferiore

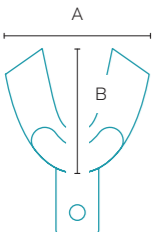

		A (mm)	B (mm)
L22	S	76	54
L21	M	79	57
L20	L	81	60

2810 Superiore

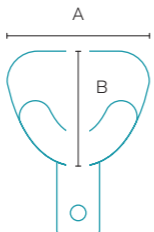

		A (mm)	B (mm)
U7	S	70	57
U4	M	71	64
U1	L	81	67

PORTAIMPRONTE NON FORATI IN ACCIAIO INOX - EDENTULI

con bordino ritentivo



2808 Inferiore

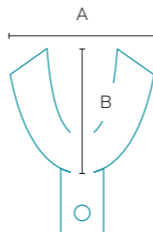

		A (mm)	B (mm)
L69	S	70	57
L68	M	73	60
L67	NL	70	64
L66	L	86	64

NL: Narrow Large (large stretta)

2808 Superiore

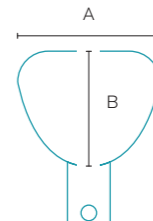

		A (mm)	B (mm)
U64	S	73	60
U63	NM	70	64
U62	M	76	67
U61	L	79	70

NM: Narrow Medium (medium stretta)

Inferiore

Superiore

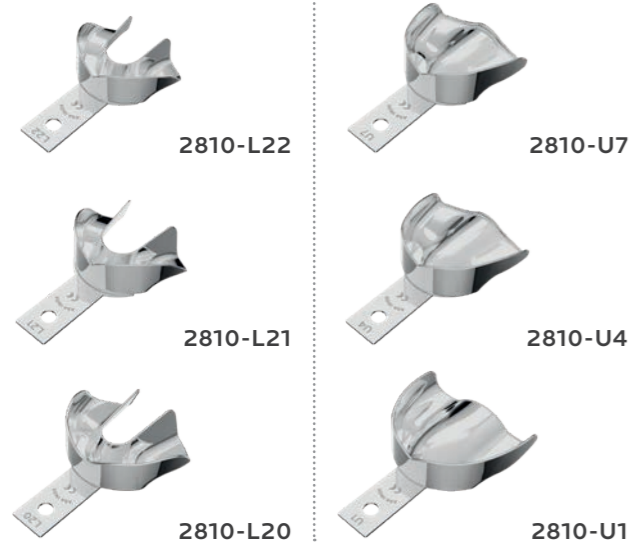

S2810-6
set da 6

Inferiore

Superiore

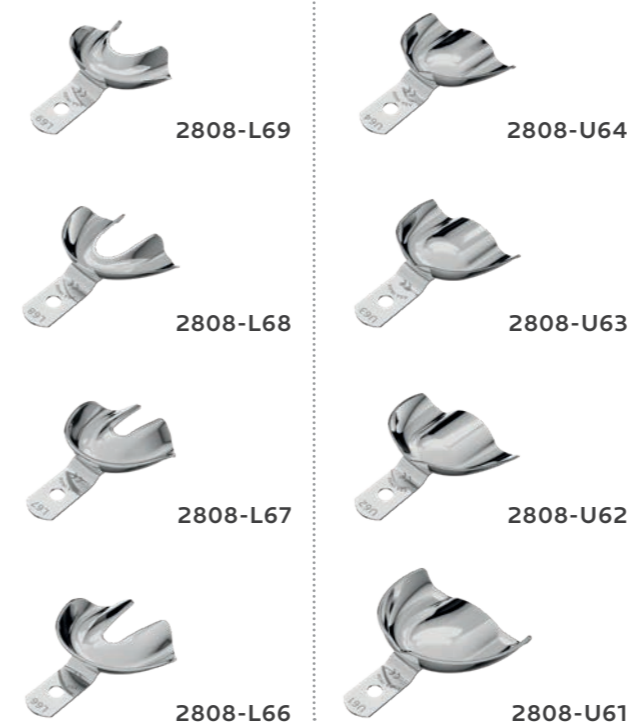

S2808-8
set da 8

PORTAIMPRONTE NON FORATI IN ACCIAIO INOX - NEW SUPER HIGH GRIP

con bordino ritentivo maggiorato e superficie interna microritentiva



S2803S-10
set da 10

PORTAIMPRONTE NON FORATI IN ACCIAIO INOX - NEW SUPER HIGH GRIP

con bordino ritentivo maggiorato e superficie interna microritentiva

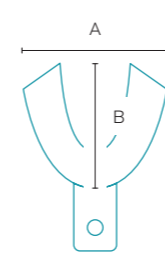

2803S Inferiore

		A (mm)	B (mm)
L5	XS	69	50
L4	S	72	57
L3	M	76	57
L2	L	78	59
L1	XL	80	63

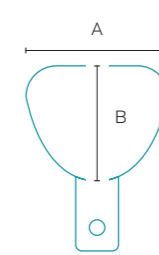

2803S Superiore

		A (mm)	B (mm)
U5	XS	65	51
U4	S	67	53
U3	M	71	55
U2	L	74	60
U1	XL	81	63

Inferiore



2803S-L5



2803S-L4



2803S-L3



2803S-L2



2803S-L1

Superiore



2803S-U5



2803S-U4



2803S-U3



2803S-U2



2803S-U1

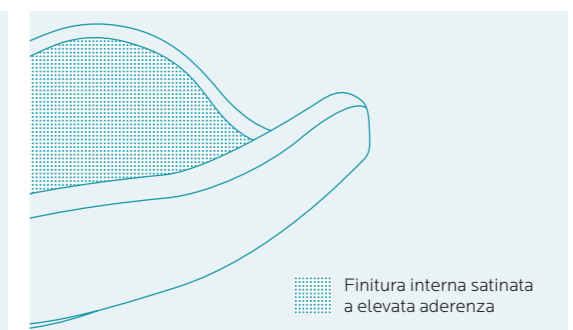
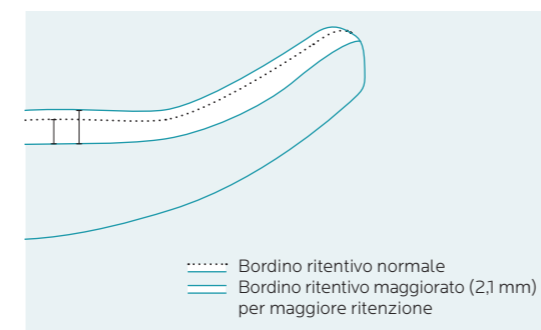

PORTAIMPRONTE NON FORATI IN ACCIAIO INOX
senza bordino ritentivo



ASA Codicolor

- U1/L1
XXS
- U2/L2
XS
- U3/L3
S
- U4/L4
M
- U5/L5
L
- U6/L6
XL



PORTAIMPRONTE NON FORATI IN ACCIAIO INOX
senza bordino ritentivo

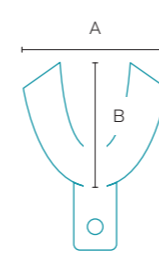

2802 Inferiore

		A (mm)	B (mm)
L1	XXS	55	47
L2	XS	60	49
L3	S	72	54
L4	M	74	57
L5	L	76	59
L6	XL	78	61

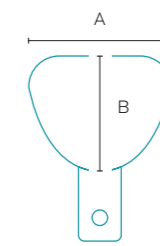

2802 Superiore

		A (mm)	B (mm)
U1	XXS	61	47
U2	XS	64	51
U3	S	66	53
U4	M	69	57
U5	L	71	60
U6	XL	73	62

Inferiore



2802-L1



2802-L2



2802-L3



2802-L4

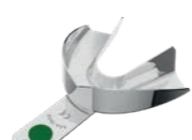

2802-L5

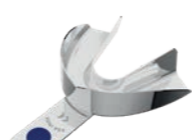

2802-L6

Superiore



2802-U1



2802-U2



2802-U3



2802-U4



2802-U5



2802-U6

Parziale



2802-L2D



2802-L4D



2802-L6D

Parziale



2802-L2S



2802-L4S









2802-L6S

PORTAIMPRONTE NON FORATI IN ACCIAIO INOX - ANATOMIC

senza bordino ritentivo



ASA Codicolor

-  U1/L1
XXS
-  U2/L2
XS
-  U3/L3
S
-  U4/L4
M
-  U5/L5
L
-  U6/L6
XL



S2802A-12
set da 12



S2802A-8
set da 8

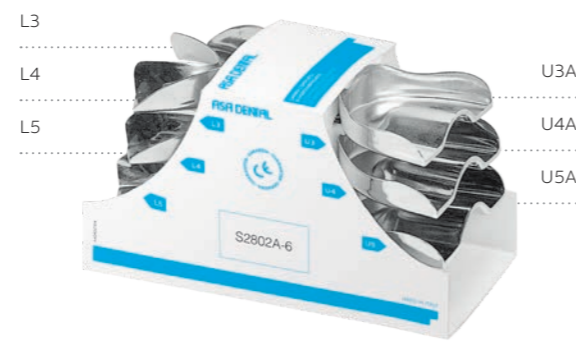

S2802A-6
set da 6

PORTAIMPRONTE NON FORATI IN ACCIAIO INOX - ANATOMIC

senza bordino

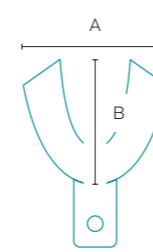

2802 Inferiore

		A (mm)	B (mm)
L1	XXS	55	47
L2	XS	60	49
L3	S	72	54
L4	M	74	57
L5	L	76	59
L6	XL	78	61

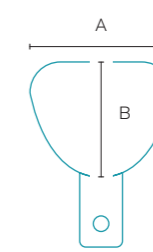

2802 Superiore

		A (mm)	B (mm)
U1A	XXS	61	47
U2A	XS	64	51
U3A	S	66	53
U4A	M	69	57
U5A	L	71	60
U6A	XL	73	62

Inferiore



2802-L1



2802-L2



2802-L3



2802-L4



2802-L5



2802-L6

Superiore



2802-U1A



2802-U2A



2802-U3A



2802-U4A



2802-U5A



2802-U6A

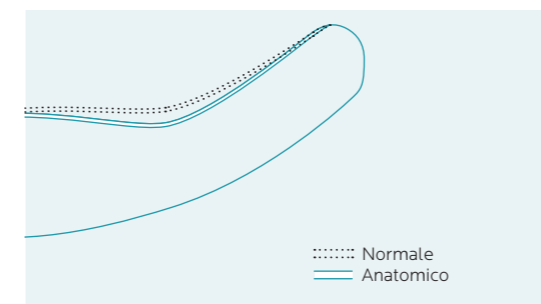

PORTAIMPRONTE FORATI IN ALLUMINIO

senza bordino ritentivo



S2800-12
set da 12

PORTAIMPRONTE FORATI IN ALLUMINIO

senza bordino ritentivo

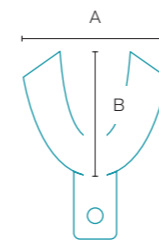

2800 Inferiore

		A (mm)	B (mm)
L1	XXS	56	48
L2	XS	59	50
L3	S	72	52
L4	M	76	57
L5	L	77	56
L6	XL	78	59

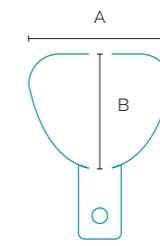

2800 Superiore

		A (mm)	B (mm)
U1	XXS	63	48
U2	XS	66	51
U3	S	68	54
U4	M	71	58
U5	L	74	62
U6	XL	76	63

Inferiore



2800-L1



2800-L2



2800-L3



2800-L4



2800-L5



2800-L6

Superiore



2800-U1



2800-U2



2800-U3



2800-U4



2800-U5



2800-U6

Parziale



2800-L2D



2800-L4D



2800-L6D

Parziale



2800-L2S



2800-L4S



2800-L6S

PORTAIMPRONTE FORATI IN ALLUMINIO PER IMPLANTOLOGIA

senza bordino ritentivo



PORTAIMPRONTE FORATI IN ALLUMINIO PER IMPLANTOLOGIA

senza bordino ritentivo

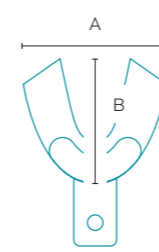

2880 Inferiore

		A (mm)	B (mm)
L1	XXS	56	48
L2	XS	59	50
L3	S	72	52
L4	M	76	57
L5	L	77	56
L6	XL	78	59

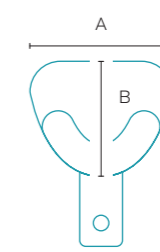

2880 Superiore

		A (mm)	B (mm)
U1	XXS	63	48
U2	XS	66	51
U3	S	68	54
U4	M	71	58
U5	L	74	62
U6	XL	76	63

Inferiore



Superiore



S2880-12
set da 12
S2880-12FR
set da 12 più fresa



2880-FR
fresa in carburo di tungsteno
con taglio a spirale fino
per la lavorazione di leghe in alluminio

PORTAIMPRONTE FORATI IN ALLUMINIO - ORTHOBABY PER BAMBINI
 senza bordino ritentivo

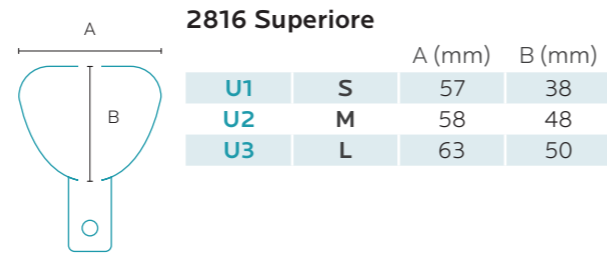
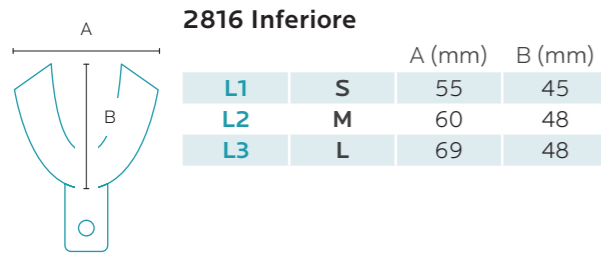

Inferiore

Superiore



2816-L1



2816-U1



2816-L2



2816-U2



2816-L3



2816-U3



S2816-6
set da 6



PORTAIMPRONTE OCCLUSALI PARZIALI IN ACCIAIO INOX

permettono di prendere l'impronta di due semi-arcate antagoniste



2819-OCG



2819-OCP

ASACLEAN

soluzione pronta all'uso a PH neutro per la rimozione di alginato da portaimpronte e strumenti



8020
contenuto 1000 ml

PORTAIMPRONTE FORATI IN ALLUMINIO COLORATE PER IMPLANTOLOGIA

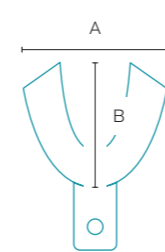

2814 Inferiore

		A (mm)	B (mm)
L0	XS	69	50
L1	S	72	57
L2	M	76	57
L3	L	78	59
L4	XL	80	63

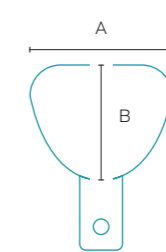

2814 Superiore

		A (mm)	B (mm)
U0	XS	65	51
U1	S	67	53
U2	M	71	55
U3	L	74	60
U4	XL	81	63

Inferiore



2814-L0



2814-L1



2814-L2



2814-L3



2814-L4

Superiore



2814-U0



2814-U1



2814-U2



2814-U3



2814-U4

PORTAIMPRONTE IN POLICARBONATO

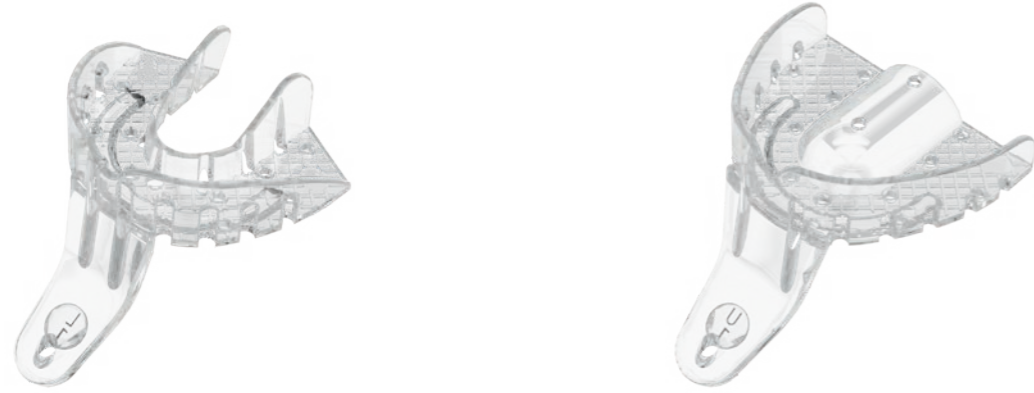

2852-12
set da 12

Inferiore

	A (mm)	B (mm)
L1	61	50
L2	67	52
L3	72	56
L4	74	58

Superiore

	A (mm)	B (mm)
U1	61	49
U2	65	53
U3	70	59
U4	73	6

PORTAIMPRONTE ORTODONTICI IN POLICARBONATO - PER BAMBINI



2850-8
set da 8

Inferiore

	A (mm)	B (mm)
L1	52	44
L2	58	49
L3	62	53
L4	66	56

Superiore

	A (mm)	B (mm)
U1	50	46
U2	56	51
U3	59	55
U4	63	59

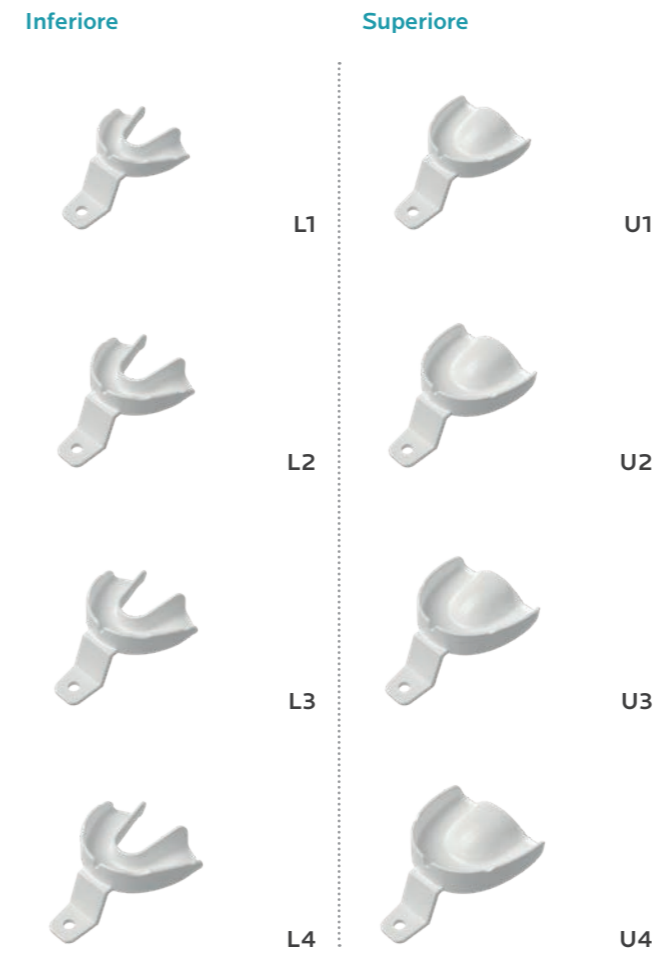
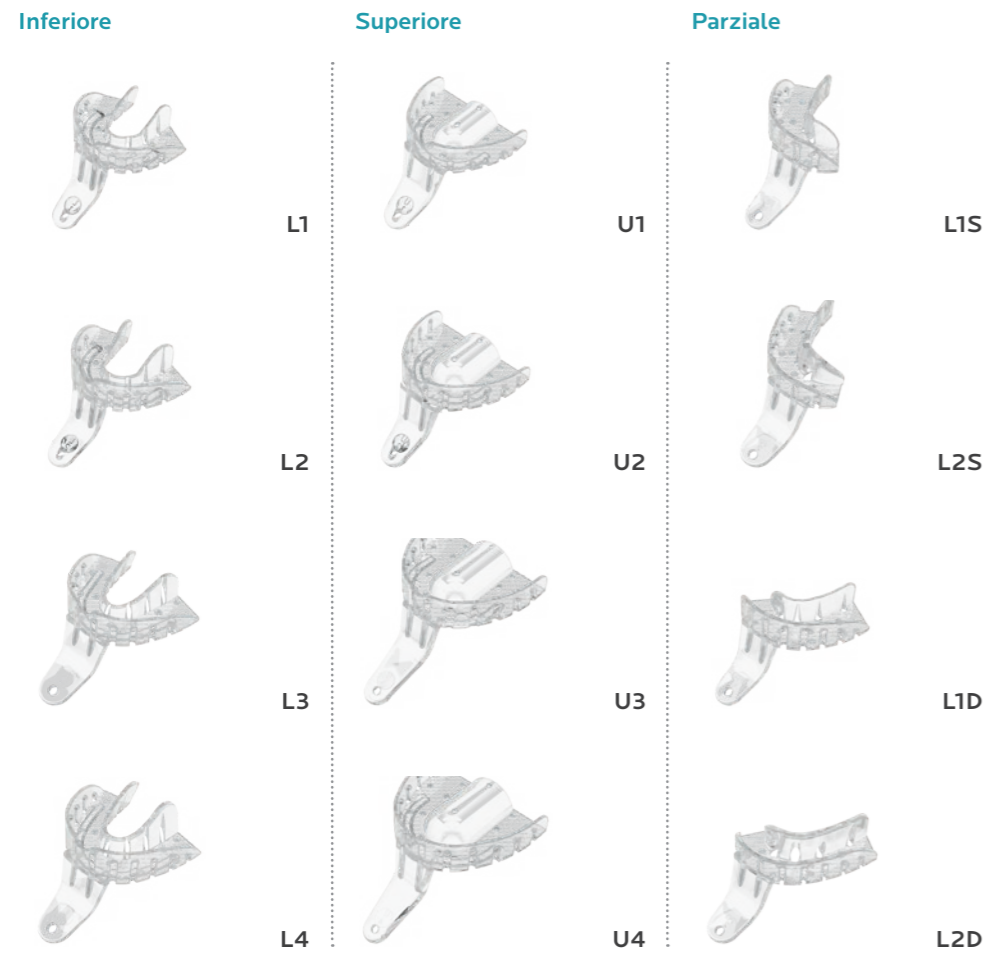

PORTAIMPRONTE IN POLICARBONATO - EDENTULI

sterilizzabili in autoclave max. 130°C



S2851-24
set da 24
13x inferiore
7x superiore
4x misti
compasso

2851-13
set da 13
inferiore

2851-7
set da 7
superiore

PORTAIMPRONTE IN POLICARBONATO - EDENTULI

sterilizzabili in autoclave max. 130°C

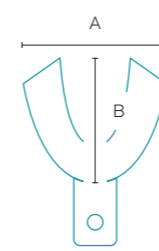

Inferiore

	A (mm)	B (mm)
L1	57	49
L2	58	53
L3	60	54
L4	61	55
L5	61	56
L6	61	57
L7	62	57
L8	64	55
L9	64	59
L10	66	57
L11	65	60
L12	67	56
L13	70	59

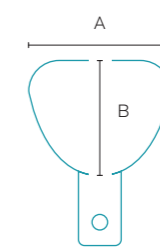

Superiore

	A (mm)	B (mm)
U1	62	53
U2	64	57
U3	61	58
U4	66	60
U5	70	62
U6	74	63
U7	75	64

Miste

	A (mm)	B (mm)
U1P	64	54
U2P	67	58
L1C	75	49
L2C	75	54

Inferiore

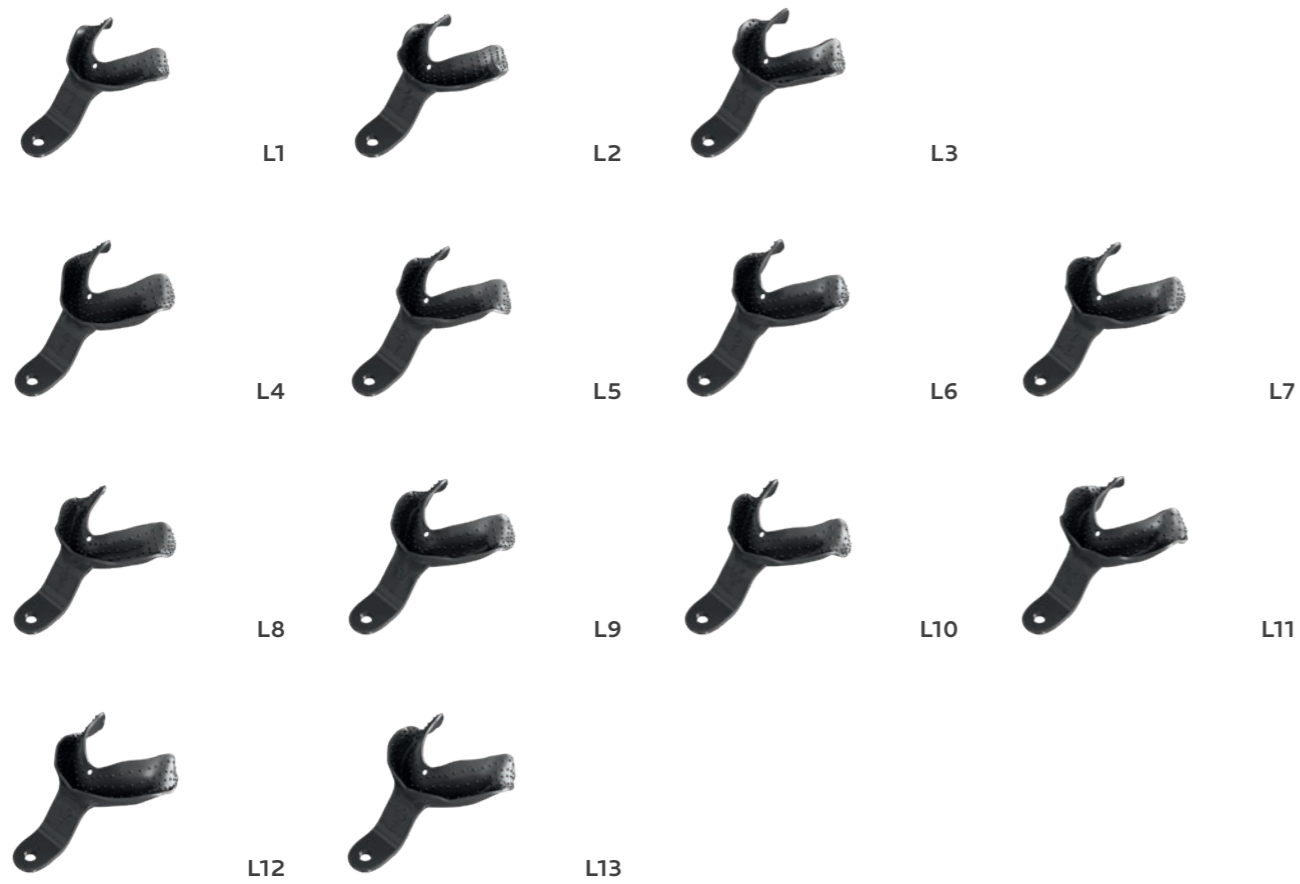

Superiore

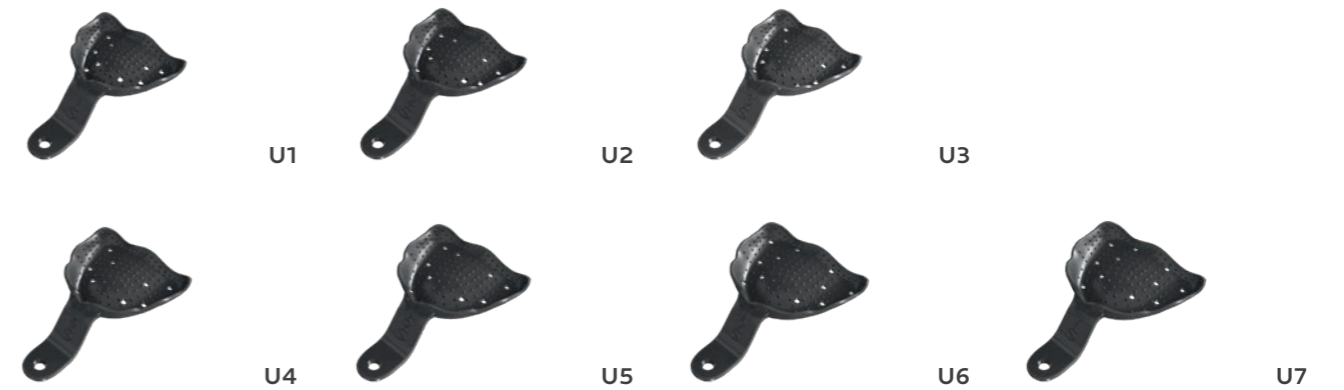

Miste



STRUMENTI PER LABORATORIO

MADE IN ITALY



LA FORMULA VINCENTE: OTTIMA COMPETENZA E TECNICA AVANZATA

Per ottenere risultati insperati e trasformare impronte dentali in protesi efficaci è fondamentale il lavoro che un odontotecnico svolge dietro le quinte. Sulla base di precise informazioni che comprendono dettagli anatomici e funzionali, il lavoro dello specialista integra competenze tecniche, capacità artistiche, materiali avanzati e strumenti di elevata precisione per creare qualsiasi tipo di ricostruzione, incluse corone, ponti, protesi parziali, complete o rimovibili.

Gli strumenti per laboratorio di Asa Dental spaziano da articolatori a valori medi estremamente versatili,

attraverso un'ampia gamma di accessori, fino a strumenti di modellazione precisi, tutti necessari per creare le forme migliori e aiutare gli esperti a ripristinare l'aspetto estetico e funzionale della bocca dei loro pazienti.

L2	Articolatori
L10	Easy Bow
L13	Strumenti per modellare cera
L18	Strumenti per cera
L19	Pinzette
L20	Pennelli per ceramica
L21	Strumenti per ceramica
L22	Coltelli
L24	Spatole e tazze
L27	Contenitori per protesi
L28	Forbicine
L29	Strumenti per corone
L30	Calibri
L31	Martelli
L32	Pinze per cilindri e muffole
L33	Seghetti e lame
L34	Kit



ARTICOLATORI

Valori medi

Progettati per semplificare e velocizzare le operazioni su qualsiasi modello, il 5050 e il 5050PLUS sono articolatori non-Arcon a valori medi che rispondono con assoluta precisione alle esigenze dei professionisti, indipendentemente dalla tecnica di protesizzazione utilizzata. La struttura leggera, stabile ed ergonomica facilita set-up e lavoro sia partendo dall'arcata superiore che da quella inferiore, con la possibilità di lavorare comodamente inclinando l'articolatore a 60°. Le caratteristiche di questi articolatori permettono di simulare esattamente il tragitto condiloideo per garantire quella precisione che dona a protesi e ricostruzioni dentali funzionalità e occlusione ottimali, qualunque sia il movimento mandibolare del paziente.

L'articolatore 5050 permette di lavorare efficacemente su protesi e modelli di diverse misure ed è compatibile con i polimerizzatori a pressione disponibili in commercio. Progettato pensando all'ergonomia dell'operatore, offre una stabilità totale nella posizione di lavoro standard, in quella a 60° che privilegia il comfort dell'operatore, ma anche ruotato sottosopra, nel caso di pazienti edentuli in classe III.

Il sistema anti-rotazione dell'asta incisale garantisce un posizionamento non solo preciso ma anche corretto, mentre l'asta antiribaltamento assicura la necessaria stabilità quando la branca superiore è completamente aperta. Il piano occlusale e le calotte hanno 4 linee ellittiche di riferimento per assistere nel corretto posizionamento del modello indipendentemente dalle dimensioni, sia partendo dall'arcata superiore che da quella inferiore.

CARATTERISTICHE TECNICHE

- Design per posizione di lavoro ergonomica a 60°
- Ideale per pazienti di classe III
- Compatibile per dimensione con i polimerizzatori a pressione in commercio
- Sistema anti-rotazione per asta incisale
- Calotta con 4 traiettorie ellittiche di riferimento per modelli a partire da arcata inferiore
- Piano occlusale con 4 traiettorie ellittiche di riferimento per modelli a partire da arcata superiore
- Asta antiribaltamento per stabilità ad apertura completa
- Sistema di protezione antishock

Dati tecnici

Distanza intercondilare	110 mm
Inclinazione condilare fissata a	30°
Angolo di Bennett	0 - 7°
Inclinazione base incisale	10°
Distanza fra le piastrine di montaggio	87 mm
Apertura	180°

Include:

4 piastrine di montaggio	5000-1
2 viti di serraggio	5011-6



5050

ARTICOLATORI

Valori medi

Il 5050PLUS è sicuramente l'articolatore più versatile tra quelli che compongono la linea di prodotti per laboratorio di Asa Dental. In aggiunta alle prestazioni offerte dal 5050, il 5050PLUS offre il vantaggio dell'esclusivo sistema ad asta posteriore con piano inclinato che garantisce assoluta precisione anche quando, per aumentare la visibilità, l'operatore rimuove l'asta incisale: la vite di regolazione posteriore conserva inalterate le traiettorie e le inclinazioni durante le varie combinazioni dei movimenti di lateralità, protrusione e retrusione.

Completa la configurazione un sistema ad asta incisale magnetica che previene qualsiasi alterazione del modello durante le fasi di solidificazione del gesso. Semplice, preciso ed ergonomico, il 5050PLUS è la risposta più efficace da parte di Asa Dental a tutti gli odontotecnici che richiedono un articolatore a valori medi non-Arcon versatile e affidabile.

CARATTERISTICHE TECNICHE

- Design per posizione di lavoro ergonomica a 60°
- Ideale per pazienti di classe III
- Compatibile per dimensione con i polimerizzatori a pressione in commercio
- Sistema anti-rotazione per asta incisale
- Sistema con asta posteriore regolabile per lavorazioni precise anche senza asta incisale
- Calotta con 4 traiettorie ellittiche di riferimento per modelli a partire da arcata inferiore
- Piano occlusale con 4 traiettorie ellittiche di riferimento per modelli a partire da arcata superiore
- Asta incisale magnetica per stabilità totale durante la cristallizzazione del gesso
- Asta antiribaltamento per stabilità ad apertura completa
- Sistema di protezione antishock

Dati tecnici

Distanza intercondilare	110 mm
Inclinazione condilare fissata a	30°
Angolo di Bennett	0 - 7°
Inclinazione base incisale	0°
Distanza fra le piastrine di montaggio	87 mm
Piano di contrasto inclinato	24°
Apertura	180°

Include:

4 piastrine di montaggio	5000-1
2 viti di serraggio	5011-6



5050PLUS

ARTICOLATORI

Valori medi

Articolatore anatomico in lega di alluminio pressofuso utilizzabile con il piano di Camper o con arco facciale arbitrario; bloccaggio in relazione alla centrica:

- Ritorno automatico in asse cerniera con molle di richiamo
- Perfetta stabilità in posizione aperta
- Asse cerniera con antishock che preserva l'asse cerniera da rottura o grave danneggiamento in caso di caduta accidentale dell'articolatore
- Viti maggiorate per piastre
- Le spalle posteriori hanno un andamento anatomico che favorisce una salda e pratica tenuta dell'articolatore

CARATTERISTICHE TECNICHE

Altezza e larghezza maggiori

- Più spazio quando si usano i sistemi per monconi sfilabili
- Più spazio per il montaggio delle protesi mobili con masticazioni alte o zoccoli grandi
- Più spazio quando si utilizzano le piastri magnetiche
- Migliore accesso posteriore
- Distanza di lavoro interna variabile
- Asta incisale ed asta antiribaltamento in acciaio
- Asse cerniera in acciaio
- Protezione con sistema antishock

Dati tecnici

Distanza intercondilare	120 mm
Inclinazione condilare fissata a	30°
Angolo di Bennett fissato a	7°
Inclinazione base incisale	10°
Distanza fra le piastri di montaggio	90-110 mm
Peso	700 gr
Apertura	180°

Include:

2 distanziatori	5030-29
4 piastri di montaggio	5000-1
2 viti di serraggio per distanziatore	5030-6
2 viti di serraggio per piastri	5011-6

Accessori

Arco facciale	5021
Tavolo di trasferimento	5024
Piano di occlusione	5030-2
Taratore	5033



5030

**ARTICOLATORI**

Valori medi

Il 5032 ha le stesse caratteristiche del 5030 più:

- Asta posteriore regolabile con vite micrometrica di registro, per lavorare con asta incisale rimossa, con mantenimento inalterato delle traiettorie e inclinazioni nei movimenti di lateralità e protrusiva/retrusiva
- Movimento di traslazione pura (istruzioni e chiavetta per l'attivazione fornite insieme al prodotto)

CARATTERISTICHE TECNICHE

Asta posteriore sulla parte superiore per accesso e visibilità posteriore inalterati asse cerniera con possibilità di movimento traslazione pura.

Dati tecnici

Distanza intercondilare	120 mm
Inclinazione condilare fissata a	30°
Angolo di Bennett fissato a	7°
Inclinazione base incisale	10°
Distanza fra le piastri di montaggio	90-110 mm
Peso	700 gr
Apertura	180°

Include:

2 distanziatori	5030-29
2 piastri magnetiche	5000-1M
2 viti di serraggio per distanziatore	5030-6
2 viti di serraggio per piastri	5011-6

Accessori

Arco facciale	5021
Tavolo di trasferimento	5024
Piano di occlusione	5030-2
Taratore	5033



5032



ARTICOLATORI

Valori medi

Include:

2 piastrine di montaggio	5000-1
2 viti di serraggio per piastrine	5050-6



5002

OCCLUSORE



5001

ARTICOLATORI

Parti di ricambio

- Piastrina di montaggio
- Piastrina in pressofusione in alluminio
- Utilizzabile sugli articolatori:
5050
5050PLUS
5030
5032
5002
5000
5010
5011

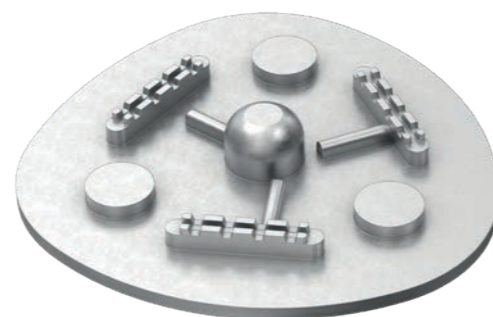

5000-1

ARTICOLATORI

Parti di ricambio

5000-26

Magnete



5000-26



5000-30

Camicia porta magnete



5000-30

5000-1M

- Piastrina pressofusa in alluminio teflonato
- Camicia porta magnete (5000-30)
- Magnete (5000-26)
- Utilizzabile sugli articolatori:
5050
5050PLUS
5030
5032
5002
5000
5010
5011

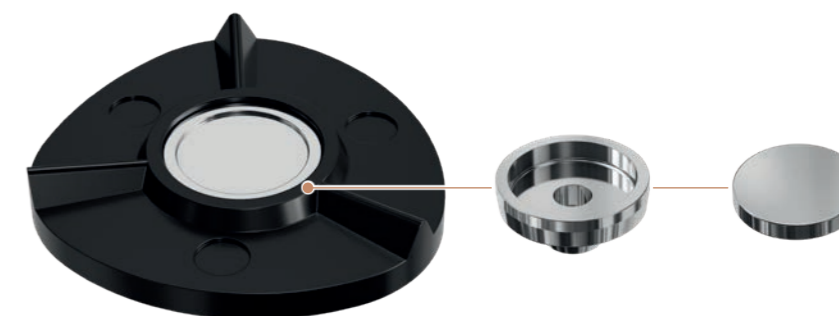

5000-1M

5000-30

5000-26

5000-25

- Contromagnete per gesso per piastrina pressofusa in alluminio teflonato
- 10 pz / confezione



5000-25

5030-29

- Distanziatore
- Utilizzabile sugli articolatori:
5030
5032



5030-29

ARTICOLATORI

Parti di ricambio

5050PLUS



5050

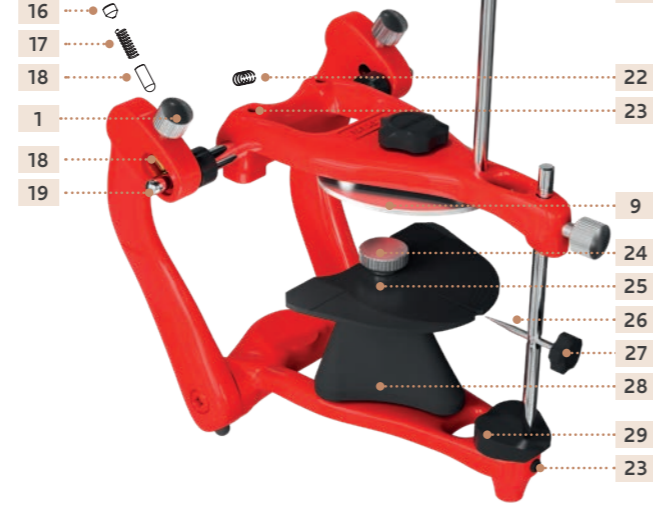

5030/5032

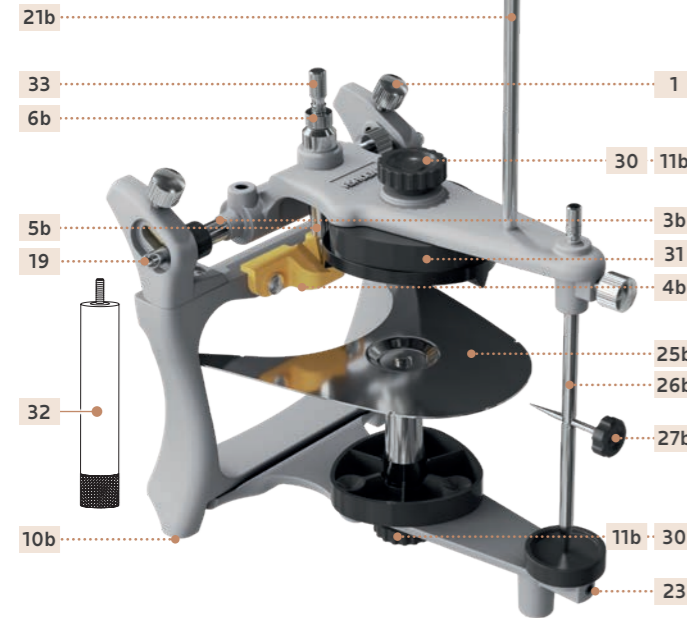

ARTICOLATORI

Parti di ricambio

		5050PLUS	5050	5032	5030
1	Pomello metallico di serraggio	5000-5	5000-5	5000-5	5000-5
2	Rondella di rasamento asse cerniera	5011-18	5011-18	5011-18	5011-18
3, 3b	Asse cerniera	5050-17	5050-17	5032-17	5032-17
4, 4b	Piano inclinato di contrasto	5011-16		5032-16	
5, 5b	Asta posteriore	5050-21		5032-21	
6, 6b	Contro vite	5011-23		5032-23	
7	Porta asta posteriore	5050-20			
8	Calotta	5052	5052		
9	Piastrina di montaggio	5000-1	5000-1	5000-1	5000-1
10, 10b	Piedini in gomma (6 pz / confezione)	5050-24	5050-24	5000-24	5000-24
11, 11b	Vite di serraggio	5050-6	5050-6	5011-6	5011-6
12	Ghiera per asta	5053-2			
13	Asta con magnete incollato	5053-1			
14	Piano per asta magnetica	5053-3			
12+13+14	Kit asta magnetica	5053			
15	Piano incisale (0°)	5011-4		5011-4	
16	Vite per regolazione molla movimenti laterali	5000-7	5000-7	5000-7	5000-7
17	Molla per movimenti laterali	5000-12	5000-12	5000-12	5000-12
18	Cilindro per movimenti laterali	5000-13	5000-13	5000-13	5000-13
19	Asta movimento condilare	5030-9	5030-9	5030-9	5030-9
20	Cappuccio in gomma	5011-11	5011-11	5011-11	5011-11
21, 21b	Asta antiribaltamento	5010-10	5010-10	5030-10	5030-10
22	Molla interna asse cerniera	5011-19	5011-19	5011-19	5011-19
23	Viti M5 per fissaggio base incisale	5000-18	5000-18	5000-18	5000-18
24	Vite zigrinate per piano oclusale e calotta	5050-4	5050-4		
25, 25b	Piano di occlusione	5051	5051	5030-2	5030-2
26, 26b	Asta incisale	5050-3	5050-3	5030-3	5030-3
27, 27b	Indicatore incisale	5050-8	5050-8	5000-8	5000-8
28	Supporto per piano oclusale e calotta	5050-2	5050-2		
24+25+28	Piano oclusale completo (5050-4 + 5051 + 5050-2)	5054	5054		
29	Piano incisale (10°)		5000-4N		5000-4N
30	Vite di serraggio per distanziatore			5030-6	5030-6
31	Distanziatore			5030-29	5030-29
32	Taratore			5033	5033
33	Vite micrometrica di registrazione			5032-22	
34	Piastrina magnetica completa	5000-1M	5000-1M	5000-1M	5000-1M
35	Magnete	5000-26	5000-26	5000-26	5000-26
36	Contromagneti per gesso (10 pz / confezione)	5000-25	5000-25	5000-25	5000-25
37	Camicia porta magnete	5000-30	5000-30	5000-30	5000-30

EASY BOW

5020

set completo arco facciale corredato di tre forchette con tavolo di trasferimento per articolatore

Arco facciale	5021
Blocco porta forchetta	5022
Tavolo di trasferimento	5024
Forchetta	5023-1
Forchetta	5023-2
Forchetta	5023-3

set utilizzabile sugli articolatori:

5030
5032



5021



5022



5024



5023-1



5023-2



5023-3

EASY BOW

istruzioni d'utilizzo

1. Inserire il blocco porta forchetta nell'arco
2. Inserire la forchetta nella bocca del paziente
3. Tirare le estremità delle olive auricolari verso l'esterno e inserire l'arco
4. Regolare la posizione del Nasion tenendo a riferimento il piano di Francoforte
5. Collegare l'asta porta forchetta e serrare tutti i pomelli
6. Arco facciale inserito
7. Tirare le estremità delle olive auricolari verso l'esterno ed estrarre l'arco
8. Allentare il pomello ed estrarre il blocco porta forchetta
9. Posizionare il blocco porta forchetta nel tavolino di trasferimento...
10. ...e serrare il pomello
11. Se necessario regolare l'altezza del pianetto; successivamente rimuovere il blocco porta forchetta
12. Porre il gesso sul pianetto e riposizionare il blocco porta forchetta
13. Dopo che il gesso è indurito allentare il pomello dell'asta porta forchetta...
14. ...ed estrarre l'asta
15. Allentare il pomello ed estrarre il blocco porta forchetta
16. Posizionare il tavolo sull'articolatore...
17. ...inserendolo negli appositi alloggi
18. Fissare il tavolo sull'articolatore con la vite già in dotazione all'articolatore
19. Posizionare il modello sul "morso"
20. Porre il gesso sul modello...
21. ...concludere la "messa in articolatore" come di norma

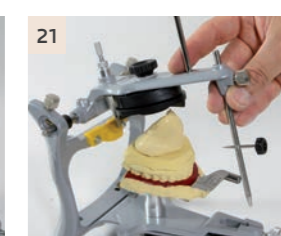
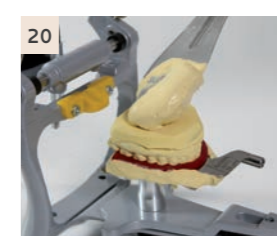
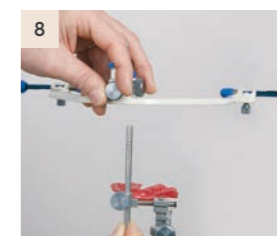
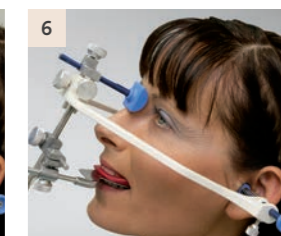
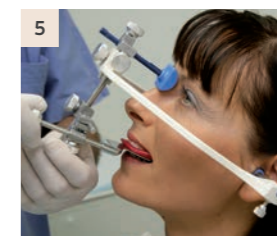
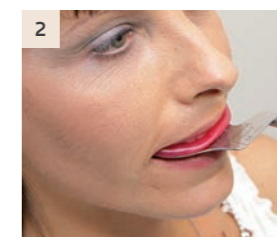

MANICI

PUNTA SINGOLA

- Alu80
(alluminio, vuoto)
ø 8,0 mm



PUNTA DOPPIA

- Asa60
(acciaio inox)
ø 6,0 mm



- Asa Light MV
(acciaio inox, vuoto)
ø 8,0 mm



- Alu80
(alluminio, vuoto)
ø 8,0 mm



STRUMENTI PER MODELLARE

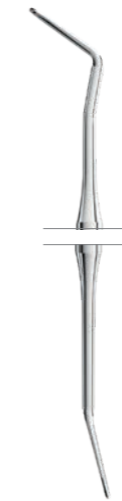

1 Ward
1501-1
Asa60
MV1501-1
Asa Light MV



1S Ward
1501-1S
Asa60
MV1501-1S
Asa Light MV

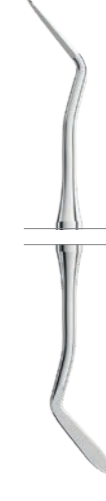

2 Ward
1501-2
Asa60
MV1501-2
Asa Light MV

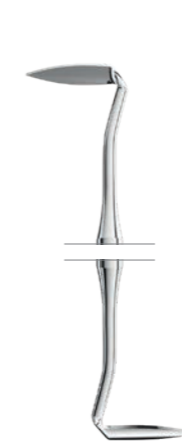

1/2 Hollenback
1500-02
Asa60
MV1500-02
Asa Light MV



3 Hollenback
1500-3
Asa60
MV1500-3
Asa Light MV



3S Hollenback
1500-3S
Asa60
MV1500-3S
Asa Light MV



2 USC
1503-2
Asa60



1 Frahm
1502-1
Asa60
MV1502-1
Asa Light MV

STRUMENTI PER MODELLARE

STRUMENTI PER MODELLARE

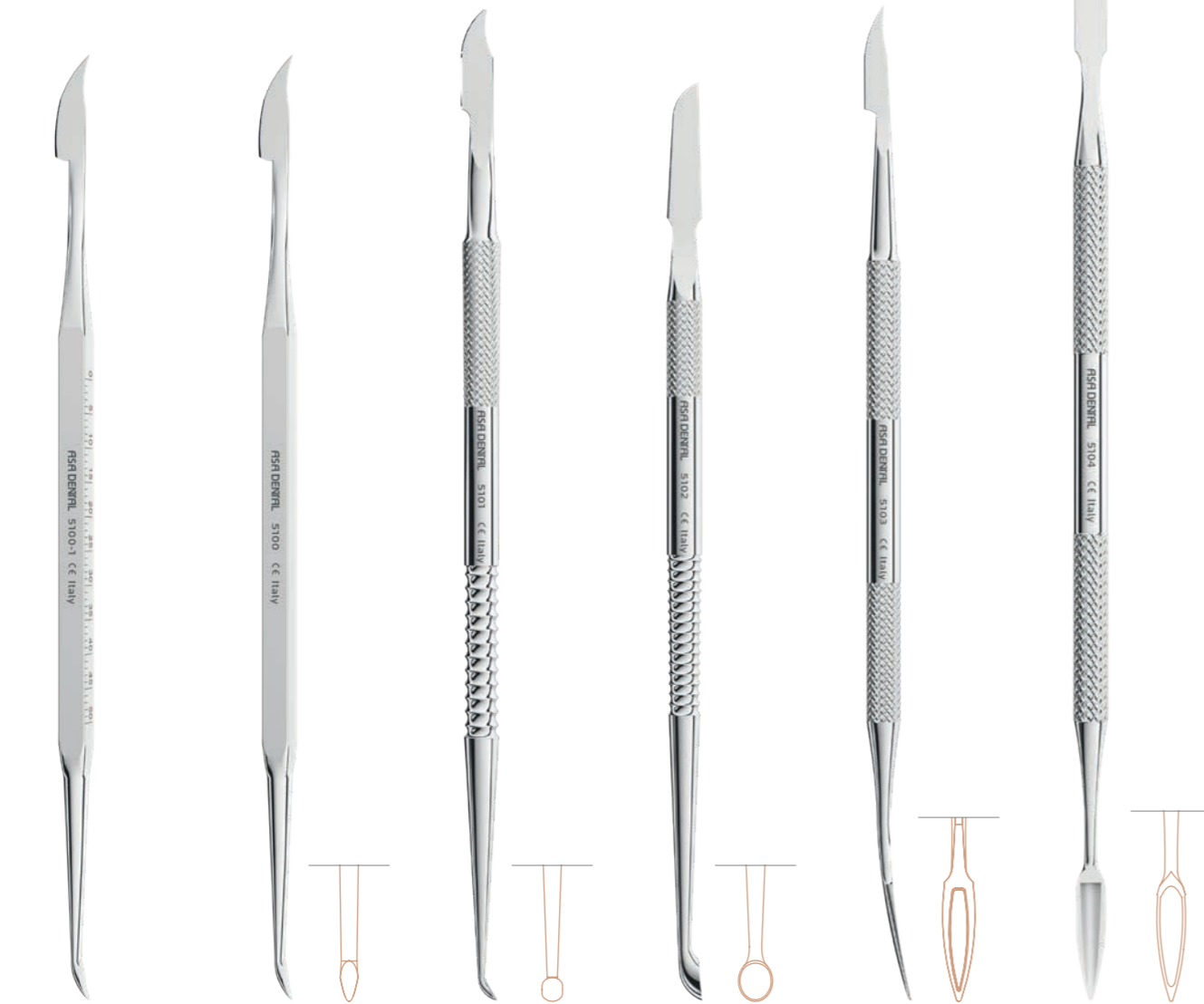

Hylin
manico
millimetrato
in mm
5100-1

Hylin
5100

Hylin-Le Cron
5101

Hylin-Ceramica
5102

Hylin-ASA
5103

ASA
5104



Le Cron
5105

Le Cron
5106

Le Cron
5107

Le Cron
5108

Zahle
5109

Zahle
5110

STRUMENTI PER MODELLARE

STRUMENTI PER MODELLARE

Set da 5



Modello	Codice Set	Manico
1 · 2 · 3 · 4 · 5	S5112	Asa60
1AL · 2AL · 3AL · 4AL · 5AL	S5112AL	Alu80

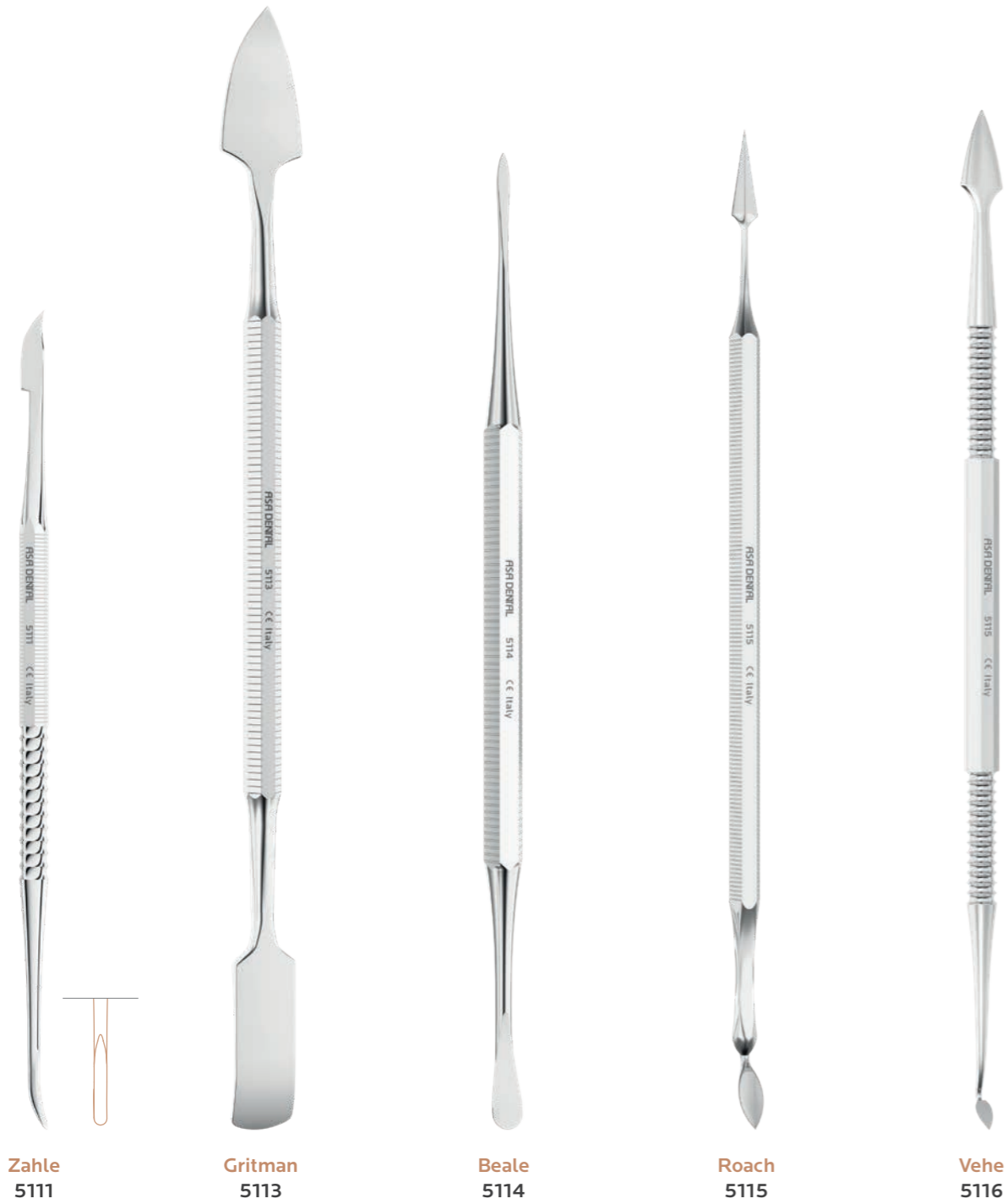

Zahle
5111

Gritman
5113

Beale
5114

Roach
5115

Vehe
5116

2 P. K. Thomas
5112-2
Asa60

3 P. K. Thomas
5112-3
Asa60

2 P. K. Thomas
5112-2AL
● Alu80

3 P. K. Thomas
5112-3AL
● Alu80

1 P. K. Thomas
5112-1
Asa60

4 P. K. Thomas
5112-4
Asa60

5 P. K. Thomas
5112-5
Asa60

1 P. K. Thomas
5112-1AL
● Alu80

4 P. K. Thomas
5112-4AL
● Alu80

5 P. K. Thomas
5112-5AL
● Alu80

STRUMENTI PER CERA CON PUNTE INTERCAMBIABILI

Set da 3+3



Modello	Codice Set
1-2-3-1C-2C-3C	S5160



1
S5160-1C
● Alu80



2
S5160-2C
● Alu80



3
S5160-3C
● Alu80



1
5160-1



2
5160-2



3
5160-3

PINZETTE PER LABORATORIO



1
16,5 cm
6400-1



2
16 cm
6400-2



3 Meriam
16 cm
0601-3



2
12 cm
0645-2



3
11,5 cm
0645-3



3
15 cm
0635-3



4
18 cm
0635-4



6
26 cm
0635-6

PENNELLI PER CERAMICA



7000-6 7000-8 7001-3 7001-1 7001-0 7001-00 7002-4 7002-6 7002-8

STRUMENTI PER CERAMICA E RESINE DI RIVESTIMENTO

Set da 3 manici + 6 punte

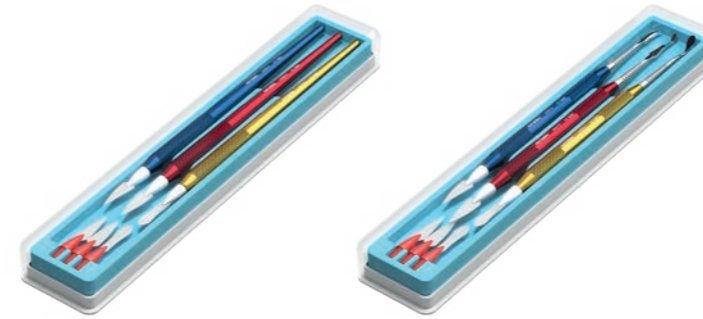

Modello	Codice Set
5150-1 · 5150-2 · 5150-3 5156-1 · 5156-2 · 5156-3	5150

Modello	Codice Set
5151-1 · 5151-2 · 5151-3 5156-1 · 5156-2 · 5156-3	5151



1 5150-1 ● Alu80 2 5150-2 ● Alu80 3 5150-3 ● Alu80
 1 Greenstein 5151-1 ● Alu80 2 Greenstein 5151-2 ● Alu80 3 Greenstein 5151-3 ● Alu80
 PUNTE FLESSIBILI 1 5155-1 2 5155-2 3 5155-3
 PUNTE SUPERFLESSIBILI 1 5156-1 2 5156-2 3 5156-3

COLTELLI PER CERA



1 Fahnenstock
13 cm
5200-1

2 Fahnenstock
17 cm
5200-2

1 Lessmann
13 cm
5201-1

2 Lessmann
18 cm
5201-2

1
13 cm
5202-1
CON SCODELLINO

2
17 cm
5202-2
CON SCODELLINO

il colore del manico può essere soggetto a variazione cromatica

COLTELLI PER GESSI



1
17 cm
5300-1

2
Gritman
17 cm
5300-2

3
15,5 cm
5300-3

4
16 cm
5300-4

il colore del manico può essere soggetto a variazione cromatica

SPATOLE RIGIDE PER ALGINATO, GESSO ED ELASTOMERI

Alginato, gesso

Alginato

Elastomeri



Il colore del manico può essere soggetto a variazione cromatica

SPATOLE FLESSIBILI PER ALGINATO, GESSO ED ELASTOMERI

Alginato, gesso

Alginato

Elastomeri



Il colore del manico può essere soggetto a variazione cromatica

SPATOLE PER ALGINATO E GESSO



18,5 cm
5401-B

18,5 cm
5401-C

18,5 cm
5401-F

18,5 cm
5401-G

18,5 cm
5401-R

18,5 cm
5401-V

TAZZE PER ALGINATO E GESSO

Ø 160 mm

Ø 140 mm

Ø 120 mm

Ø 100 mm



2,2 L
5500-16

Ø 160 mm



0,9 L
5500-14

Ø 140 mm



0,5 L
5500-12

Ø 120 mm



0,35 L
5500-10

Ø 100 mm



2,2 L
5501-16



0,9 L
5501-14



0,5 L
5501-12



0,35 L
5501-10

CONTENITORI PER PROTESI/ORTODONTICI

Scatola in plastica antiurto per apparecchi ortodontici mobili
10 pz / confezione



Blu
6900E-A



Bianco
6900E-B



Azzurro
6900E-C



Giallo
6900E-G



Rosa
6900E-R



Verde
6900E-V

FORBICINE
per fogli d'oro



1
retta
12 cm
0300-1

2
curva
12 cm
0300-2

FORBICINE UNIVERSALI
una lama dentellata



Universale
12 cm
5700

FORBICINE PER CORONE



1
retta
una lama dentellata
10,5 cm
5600-1

2
curva
una lama dentellata
10,5 cm
5600-2

1
retta
10,5 cm
5601-1

2
curva
10,5 cm
5601-2

STRUMENTI PER CORONE



13 cm
0545-1

Pinze telescopiche per corone

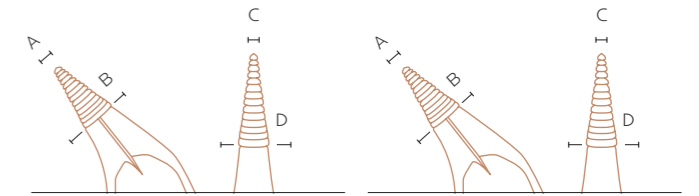

A	4,4 mm	A	3,3 mm
B	5,0 mm	B	4,0 mm
C	3,4 mm	C	2,3 mm
D	3,8 mm	D	3,0 mm



Böhm
14,5 cm
2500-2



Böhm
11,5 cm
2500-1

STRUMENTI PER CORONE

*misure indicative

Calibri con molla

scala di misurazione: 0-10 mm*



Iwanson
per cera
2550-1

scala di misurazione: 0-10 mm*



Iwanson
per metallo
2550-2

scala di misurazione: 0-15 mm*



16 cm
2557-1

Calibri decimali

scala di misurazione:
0-200 mm / 0-7 in*



alluminio
divisione in millimetri
e pollici
2556-1

scala di misurazione:
0-200 mm / 0-4 in*



Townley
divisione in millimetri
e pollici
2556-2

scala di misurazione:
0-200 mm / 0-4 in*



Jameson
divisione in millimetri
e pollici
2556-3

scala di misurazione:
0-100 mm*



Boley
14 cm
2555

CESOIA TAGLIA GESSO



Asa Special Inox
19,5 cm
5900

MARTELLI

Martelletti per rivettare

Martelletto con punta in corno



22 cm
6000



22 cm
6001



20 cm
6002

PINZE PER CILINDRI E MUFFOLE

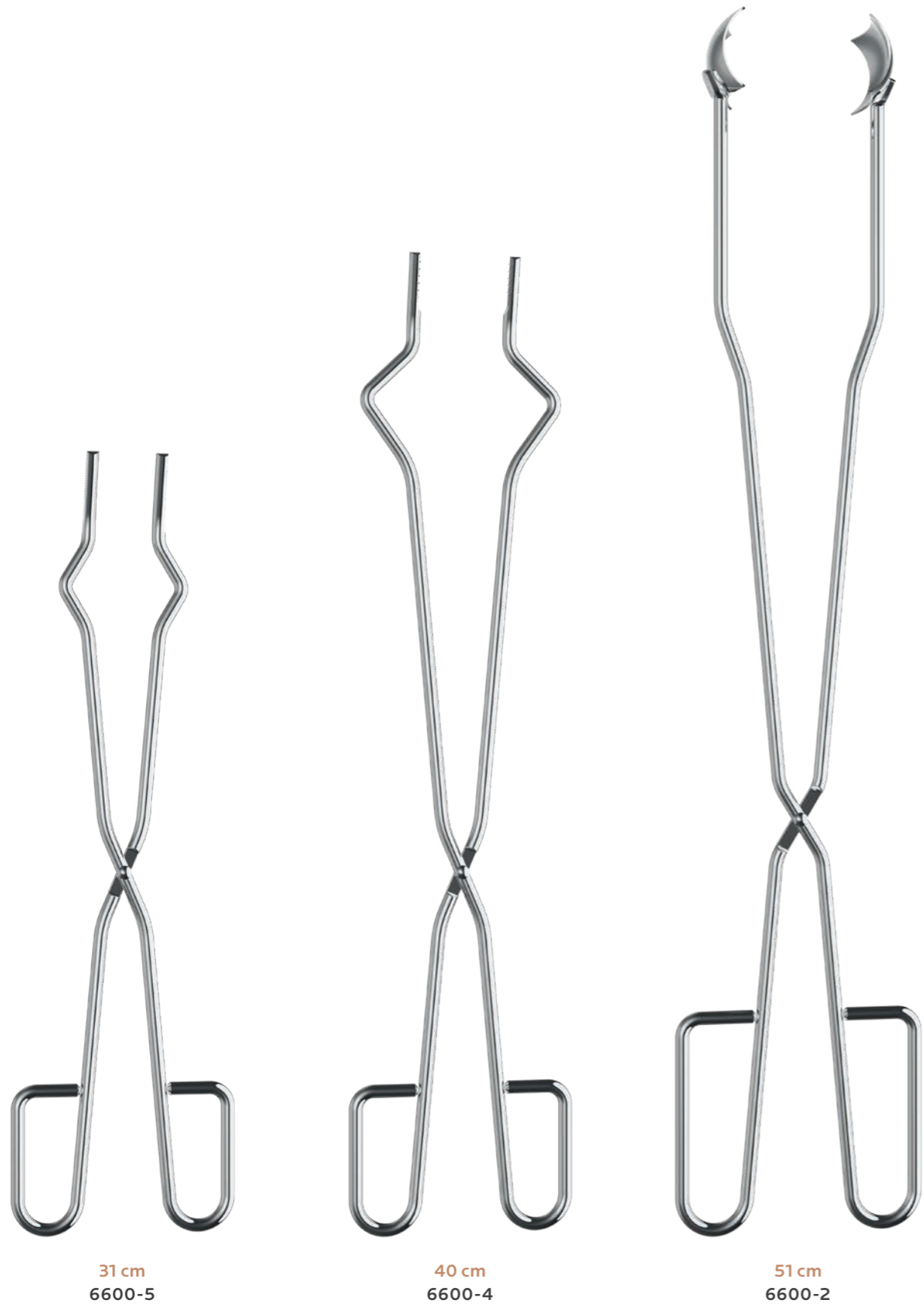

SEGHETTI E LAME

Seghetto

*Lunghezza x Altezza x Spessore



Lame seghetto

12 pz / confezione

130 mm x Ø 1,3 mm*
per gesso
6201-1

130 x 0,52 x 0,26 mm*
per metallo
6201-2

Seghetto per modelli



Lame seghetto

12 pz / confezione

75 x 3 x 0,25 mm*
6301-1

75 x 5 x 0,25 mm
6301-2

75 x 3 x 0,12 mm*
6301-3

"LAB SET" PER ODONTOTECNICA

Astuccio per modellazione cera/porcellana



S6811-2

5100	strumento per modellare Hylin	
5101	strumento per modellare Hylin-Le Cron	
5105	strumento per modellare Hylin	
5111	strumento per modellare Zahle	
5112-1	strumento per modellare P. K. Thomas	1
5112-2	strumento per modellare P. K. Thomas	2
5112-3	strumento per modellare P. K. Thomas	3
5112-4	strumento per modellare P. K. Thomas	4
5112-5	strumento per modellare P. K. Thomas	5
5113	strumento per modellare Gritman	
S5160-1C	strumento per cera	1
S5160-2C	strumento per cera	2
S5160-3C	strumento per cera	3
5200-1	coltello per cera Fahnenstock	1
5200-2	coltello per cera Fahnenstock	2
2555	calibro	

Astuccio vuoto per 17 strumenti



8000

"LAB SET" PER ODONTOTECNICA

Valigette per odontotecnica



S6810-1

6400-2	pinzetta per laboratorio	2
5900	cesoia taglia gesso	
6300	seghetto per modelli	
5500-12	tazza - ø 120 mm	
5600-2	forbicina per corone	2
5400-6	spatola per alginato e gesso	6
5300-2	coltello per gessi Gritman	2
5200-1	coltello per cera Fahnenstock	1
5200-2	coltello per cera Fahnenstock	2
5801-1	pinza per piegare fili	
2550-2	calibro Iwanson	
6001	martello	
5100	strumento per modellare Hylin	
5101	strumento per modellare Hylin-Le Cron	
5102	strumento per modellare Hylin-Ceramica	
5105	strumento per modellare Hylin	
5106	strumento per modellare Le Cron	
5109	strumento per modellare Zahle	
5113	strumento per modellare Gritman	
5114	strumento per modellare Beale	
5112-1	strumento per modellare P. K. Thomas	1
5112-2	strumento per modellare P. K. Thomas	2
5112-3	strumento per modellare P. K. Thomas	3
5112-4	strumento per modellare P. K. Thomas	4
5112-5	strumento per modellare P. K. Thomas	5



S6810-2

6400-2	pinzetta per laboratorio	2
5900	cesoia taglia gesso	
6300	seghetto per modelli	
5500-12	tazza - ø 120 mm	
5600-2	forbicina per corone	2
5400-6	spatola per alginato e gesso	6
5300-2	coltello per gessi Gritman	2
5200-1	coltello per cera Fahnenstock	1
5200-2	coltello per cera Fahnenstock	2
2550-2	calibro Iwanson	
5150	set per ceramica e resine di rivestimento	
5101	strumento per modellare Hylin-Le Cron	
5106	strumento per modellare Le Cron	
5109	strumento per modellare Zahle	
5113	strumento per modellare Gritman	
5114	strumento per modellare Beale	
5112-1	strumento per modellare P. K. Thomas	1
5112-2	strumento per modellare P. K. Thomas	2
5112-3	strumento per modellare P. K. Thomas	3
5112-4	strumento per modellare P. K. Thomas	4
5112-5	strumento per modellare P. K. Thomas	5

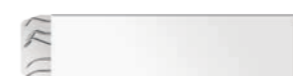

il set di strumenti per modellare, S5112, è inserito nelle valigette S6810-1 e S6810-2 all'interno di una confezione in cartoncino bianco come da immagine

INDICE DEI CODICI

CODICE	DESCRIZIONE	MANICO	PAGINA
0100-1	Pinze per estrazione		D4
0100-2	Pinze per estrazione		D4
0100-3	Pinze per estrazione		D4
0100-4	Pinze per estrazione		D4
0100-7	Pinze per estrazione		D4
0100-8	Pinze per estrazione		D4
0100-13	Pinze per estrazione		D5
0100-17	Pinze per estrazione		D5
0100-18	Pinze per estrazione		D5
0100-18A	Pinze per estrazione		D5
0100-19	Pinze per estrazione		D6
0100-20	Pinze per estrazione		D5
0100-21	Pinze per estrazione		D5
0100-22	Pinze per estrazione		D6
0100-22L	Pinze per estrazione · Routurier		D6
0100-22R	Pinze per estrazione · Routurier		D7
0100-23	Pinze per estrazione		D7
0100-24	Pinze per estrazione		D7
0100-29	Pinze per estrazione		D7
0100-29N	Pinze per estrazione		D7
0100-30	Pinze per estrazione		D8
0100-31	Pinze per estrazione		D8
0100-33	Pinze per estrazione		D8
0100-33A	Pinze per estrazione		D8
0100-33L	Pinze per estrazione		D8
0100-38A	Pinze per estrazione		D8
0100-41	Pinze per estrazione		D8
0100-43A	Pinze per estrazione		D9
0100-44	Pinze per estrazione		D9
0100-45	Pinze per estrazione		D9
0100-46	Pinze per estrazione		D9
0100-46L	Pinze per estrazione		D9
0100-48	Pinze per estrazione		D10
0100-49	Pinze per estrazione		D10
0100-51	Pinze per estrazione		D10
0100-51A	Pinze per estrazione		D10
0100-51L	Pinze per estrazione		D10
0100-51LX	Pinze per estrazione		D11
0100-52	Pinze per estrazione		D11
0100-54	Pinze per estrazione		D11
0100-55	Pinze per estrazione		D11
0100-56	Pinze per estrazione		D11
0100-59	Pinze per estrazione		D11
0100-59L	Pinze per estrazione		D11
0100-60	Pinze per estrazione		D12
0100-65L	Pinze per estrazione		D12
0100-65R	Pinze per estrazione		D12
0100-66L	Pinze per estrazione		D12
0100-66R	Pinze per estrazione		D13
0100-67	Pinze per estrazione		D13
0100-67/L	Pinze per estrazione		D13
0100-67/R	Pinze per estrazione		D13
0100-67A	Pinze per estrazione		D13
0100-68	Pinze per estrazione		D14
0100-73	Pinze per estrazione		D14
0100-74	Pinze per estrazione		D14

CODICE	DESCRIZIONE	MANICO	PAGINA
0100-74M	Pinze per estrazione		D14
0100-74N	Pinze per estrazione		D14
0100-75	Pinze per estrazione		D15
0100-79	Pinze per estrazione		D15
0100-79A	Pinze per estrazione		D15
0100-79C	Pinze per estrazione		D15
0100-86/L	Pinze per estrazione · Routurier		D16
0100-86/R	Pinze per estrazione · Routurier		D16
0100-86C	Pinze per estrazione		D16
0100-86W	Pinze per estrazione · White		D17
0100-87	Pinze per estrazione		D17
0100-89	Pinze per estrazione		D18
0100-90	Pinze per estrazione		D18
0100-99	Pinze per estrazione		D18
0100-107	Pinze per estrazione		D19
0100-121	Pinze per estrazione · Ogden-Felsch		D19
0100-145	Pinze per estrazione		D19
0100-151/	Pinze per estrazione		D19
0100-166	Pinze per estrazione · Trotter		D17
0100-167	Pinze per estrazione · Trotter		D20
0100-168	Pinze per estrazione · Trotter		D19
0100-169	Pinze per estrazione · Trotter		D20
0100-346	Pinze per estrazione		D19
0100-349	Pinze per estrazione		D20
0100-359	Pinze per estrazione		D20
0101-1	Pinze per radici e frammenti · Witzel		D40
0101-2	Pinze per radici e frammenti · Witzel		D40
0102-1	Pinze per radici e frammenti e coni d'argento · Stieglitz		D41, G3
0102-2	Pinze per radici e frammenti e coni d'argento · Stieglitz		D41, G3
0103-10	Pinze ossivore alveolotome · Luer		D42, E30
0103-20	Pinze ossivore alveolotome · Friedman		D42
0103-25	Pinze ossivore alveolotome · Mini Friedman		D42, E30, H30
0103-30	Pinze ossivore alveolotome · Blumenthal		D43, E30
0103-31	Pinze ossivore alveolotome · Blumenthal		D43, E30
0103-32	Pinze ossivore alveolotome · Blumenthal		D43
0103-40	Pinze ossivore alveolotome · Cleveland		D42
0103-45	Pinze ossivore alveolotome · Cleveland-Gardner		D42
0103-50	Pinze ossivore alveolotome · Mead		D43
0103-60	Pinze per tessuti · Goldman-Fox		D44, E29, H30
0103-70	Pinze ossivore alveolotome · Mini-Ruskin		D44
0103-71	Pinze ossivore alveolotome · Beyer		D44
0103-78	Ulocistotomi · Tomati		H30
0104-1	Pinze per estrazione · Mead		D24
0104-2	Pinze per estrazione · Mead		D24
0104-3	Pinze per estrazione · Mead		D24
0104-4	Pinze per estrazione · Mead		D24
0110-13S	Pinze per estrazione per bambini		D37
0110-22S	Pinze per estrazione per bambini		D37
0110-30S	Pinze per estrazione per bambini		D37
0110-33S	Pinze per estrazione per bambini		D37
0110-37	Pinze per estrazione per bambini		D37
0110-38	Pinze per estrazione per bambini		D38
0110-39	Pinze per estrazione per bambini		D38
0110-39L	Pinze per estrazione per bambini		D38
0110-39R	Pinze per estrazione per bambini		D38
0110-51S	Pinze per estrazione per bambini		D38
0112-1	Pinze per estrazione per bambini · Klein		D39
0112-2	Pinze per estrazione per bambini · Klein		D39
0112-3	Pinze per estrazione per bambini · Klein		D39
0112-4	Pinze per estrazione per bambini · Klein		D39
0112-5	Pinze per estrazione per bambini · Klein		D39
0112-6	Pinze per estrazione per bambini · Klein		D39
0112-7	Pinze per estrazione per bambini · Klein		D39
0120-5	Pinze per estrazione forma americana · Physick		D25
0120-6	Pinze per estrazione forma americana		D25

CODICE	DESCRIZIONE	MANICO	PAGINA
0120-10S	Pinze per estrazione forma americana		D25
0120-16	Pinze per estrazione forma americana		D25
0120-17	Pinze per estrazione forma americana		D25
0120-18L	Pinze per estrazione forma americana · Harris		D26
0120-18R	Pinze per estrazione forma americana · Harris		D26
0120-23	Pinze per estrazione forma americana		D26
0120-53L	Pinze per estrazione forma americana		D26
0120-53R	Pinze per estrazione forma americana		D26
0120-65	Pinze per estrazione forma americana		D27
0120-69	Pinze per estrazione forma americana · Tomes		D27
0120-88L	Pinze per estrazione forma americana · Nevius		D27
0120-88R	Pinze per estrazione forma americana · Nevius		D27
0120-101	Pinze per estrazione forma americana · Hull		D27
0120-150	Pinze per estrazione forma americana · Cryer		D28
0120-150S	Pinze per estrazione forma americana · Cryer		D28
0120-151	Pinze per estrazione forma americana · Cryer		D28
0120-151S	Pinze per estrazione forma americana · Cryer		D28
0120-222	Pinze per estrazione forma americana		D28
0130-1	Pinze per estrazione · manico anatomico		D33
0130-2	Pinze per estrazione · manico anatomico		D33
0130-4	Pinze per estrazione · manico anatomico		D33
0130-7	Pinze per estrazione · manico anatomico		D33
0130-13	Pinze per estrazione · manico anatomico		D33
0130-17	Pinze per estrazione · manico anatomico		D34
0130-18	Pinze per estrazione · manico anatomico		D34
0130-21	Pinze per estrazione · manico anatomico		D34
0130-22	Pinze per estrazione · manico anatomico		D34
0130-33	Pinze per estrazione · manico anatomico		D34
0130-45	Pinze per estrazione · manico anatomico		D34
0130-51A	Pinze per estrazione · manico anatomico		D34
0130-67A	Pinze per estrazione · manico anatomico		D35
0130-74	Pinze per estrazione · manico anatomico		D35
0130-79	Pinze per estrazione · manico anatomico		D35
0130-86C	Pinze per estrazione · manico anatomico		D35
0130-89	Pinze per estrazione · manico anatomico		D36
0130-90	Pinze per estrazione · manico anatomico		D36
0130-145	Pinze per estrazione · manico anatomico		D36
0130-151/	Pinze per estrazione · manico anatomico		D36
0130-349	Pinze per estrazione · manico anatomico		D36
0130-359	Pinze per estrazione · manico anatomico		D36
0200-1	Leve per radici · Bein		D49
0200-2	Leve per radici · Bein		D49
0200-3	Leve per radici · Bein		D49
0200-4	Leve per radici · Bein		D49
0200-5	Leve per radici · Bein		D49
0200-6	Leve per radici · Bein		D49
0201-1	Leve per radici · Flohr		D51
0201-2	Leve per radici · Flohr		D51
0201-3	Leve per radici · Flohr		D51
0202-320	Leve per radici · Walter F. Barry		D63
0202-321	Leve per radici · Walter F. Barry		D63
0202-322	Leve per radici · Walter F. Barry		D63
0202-323	Leve per radici · Walter F. Barry		D63
0202-350	Leve per radici · Walter F. Barry		D63
0202-351	Leve per radici · Walter F. Barry		D63
0202-370	Leve per radici · Walter F. Barry		D63
0202-371	Leve per radici · Walter F. Barry		D63
0203-1	Leve per radici · Lecluse		D65
0203-24	Leve per radici · Pott		D65
0203-25	Leve per radici · Pott		D65
0204-1L	Leve per radici · Winter		D64
0204-1R	Leve per radici · Winter		D64
0204-11L	Leve per radici · Winter		D64
0204-11R	Leve per radici · Winter		D64
0204-12L	Leve per radici · Winter		D64

CODICE	DESCRIZIONE	MANICO	PAGINA
0204-12R	Leve per radici · Winter		D64
0204-14L	Leve per radici · Winter		D64
0204-14R	Leve per radici · Winter		D64
0205-4	Leve per radici · Schmeckebier-Apexo		D51
0205-5	Leve per radici · Schmeckebier-Apexo		D51
0205-4B	Leve per radici · Schmeckebier-Apexo		D51
0205-5B	Leve per radici · Schmeckebier-Apexo		D51
0206-71	Leve per radici · Miller-Apexo		D54
0206-72	Leve per radici · Miller-Apexo		D54
0206-73	Leve per radici · Miller-Apexo		D54
0206-74	Leve per radici · Miller-Apexo		D54
0207-19	Leve per radici		D54
0207-20	Leve per radici		D54
0208-2S	Leve per radici · Seldin		D54
0208-3S	Leve per radici · Seldin		D54
0208-34	Leve per radici · Seldin		D54
0208-34S	Leve per radici · Seldin		D54
0209-1L	Leve per radici · Seldin		D55
0209-1R	Leve per radici · Seldin		D55
0209-4L	Leve per radici · Seldin		D55
0209-4R	Leve per radici · Seldin		D55
0210-51	Leve per radici · Curtis		D55
0210-52	Leve per radici · Curtis		D55
0211-11	Leve per radici · Stout		D55
0211-11A	Leve per radici · Stout		D55
0213-12	Leve per radici		D55
0214-A	Leve per radici · Cogswell		D56
0215-301	Leve per radici · Apexo		D56
0215-302	Leve per radici · Apexo		D56
0215-303	Leve per radici · Apexo		D56
0216-01W	Leve per radici · Seldin		D56
0216-04W	Leve per radici · Seldin		D56
0217-1	Leve per radici · Heidbrink		D56
0217-2	Leve per radici · Heidbrink		D56
0217-40	Leve per radici · Heidbrink		D56
0217-41	Leve per radici · Heidbrink		D56
0218-1	Leve per radici		D53
0218-2	Leve per radici		D53
0218-3	Leve per radici		D53
0218-4	Leve per radici		D53
0218-81A	Leve per radici		D58
0219-1	Leve per radici		D53
0219-2	Leve per radici		D53
0220-25	Leve per radici · Cryer		D57
0220-26	Leve per radici · Cryer		D57
0220-31	Leve per radici · Cryer		D57
0220-32	Leve per radici · Cryer		D57
0220-44	Leve per radici · Cryer		D57
0220-45	Leve per radici · Cryer		D57
0221-A1C	Leve per radici · Coupland		D58
0221-A2C	Leve per radici · Coupland		D58
0221-A3C	Leve per radici · Coupland		D58
0222-190	Leve per radici		D58
0222-191	Leve per radici		D58
0223-15	Leve per radici · Woodward		D58
0223-16	Leve per radici · Woodward		D58
0228-31F	Leve per radici · Friedman		D59
0228-32F	Leve per radici · Friedman		D59
0229-1C	Leve per radici · Coupland		D60
0229-1F	Leve per radici · Friedman		D59
0229-2C	Leve per radici · Coupland		D60
0229-2F	Leve per radici · Friedman		D59
0229-3C	Leve per radici · Coupland		D60
0230-11M	Leve per radici · Mac Millan		D58
0230-12M	Leve per radici · Mac Millan		D58

CODICE	DESCRIZIONE	MANICO	PAGINA
0230-13M	Leve per radici · Mac Millan		D58
0231-2	Leve per radici · London Hospital		D48
0231-3	Leve per radici · London Hospital		D48
0232-1	Leve per radici · Coleman		D48
0233-1	Leve per radici		D48
0233-2	Leve per radici		D48
0234-1	Leve per radici · Hylin		D45
0234-2	Leve per radici · Hylin		D45
0234-3	Leve per radici · Hylin		D45
0234-4	Leve per radici · Hylin		D45
0240-1	Leve per radici · Bein		D50
0240-2	Leve per radici · Bein		D50
0240-3	Leve per radici · Bein		D50
0240-4	Leve per radici · Bein		D50
0240-5	Leve per radici · Bein		D50
0240-6	Leve per radici · Bein		D50
0241-2	Leve per radici · Flohr		D60
0241-3	Leve per radici · Flohr		D60
0242-1	Leve per radici		D60
0242-2	Leve per radici		D60
0243-7	Leve per radici · Cryer		D57
0243-8	Leve per radici · Cryer		D57
0244-1	Leve per radici · Kopp		D52
0244-2	Leve per radici · Kopp		D52
0244-3	Leve per radici · Kopp		D52
0244-4	Leve per radici · Kopp		D52
0244-5	Leve per radici · Kopp		D52
0244-6	Leve per radici · Kopp		D52
0250-1	Leve per radici · Bein		D61
0250-2	Leve per radici · Bein		D61
0250-3	Leve per radici · Bein		D61
0250-4	Leve per radici · Bein		D61
0250-5	Leve per radici · Bein		D61
0250-6	Leve per radici · Bein		D61
0251-1	Leve per radici · Flohr		D61
0251-2	Leve per radici · Flohr		D61
0251-3	Leve per radici · Flohr		D61
0255-4	Leve per radici · Schmeckebier-Apexo		D61
0255-5	Leve per radici · Schmeckebier-Apexo		D61
0256-71	Leve per radici · Miller-Apexo		D62
0256-72	Leve per radici · Miller-Apexo		D62
0259-4L	Leve per radici · Seldin		D62
0259-4R	Leve per radici · Seldin		D62
0265-301	Leve per radici · Apexo		D62
0266-01W	Leve per radici · Seldin		D62
0267-1	Leve per radici · Heidbrink		D62
0267-2	Leve per radici · Heidbrink		D62
0267-41	Leve per radici · Heidbrink		D62
0270-25	Leve per radici · Cryer		D62
0270-26	Leve per radici · Cryer		D62
0270-44	Leve per radici · Cryer		D62
0270-45	Leve per radici · Cryer		D62
0280-2R	Ideal · straight root elevator # 2R		D46
0280-3C	Ideal · curved root elevator # 3C		D46
0280-3DF	Ideal · root elevator # 3DF		D47
0280-3R	Ideal · straight root elevator # 3R		D46
0280-5C	Ideal · curved root elevator # 5C		D47
0280-5DF	Ideal · straight root elevator # 5R		D47
0280-5R	Ideal · root elevator # 5DF		D46
0290-1	Mini-leve per frammenti di radici · Heidbrink		D66
0290-2	Mini-leve per frammenti di radici · Heidbrink		D66
0290-3	Mini-leve per frammenti di radici · Heidbrink		D66
0291-1	Leve per radici · Heidbrink		D65
0291-2	Leve per radici · Heidbrink		D65
0291-3	Leve per radici · Heidbrink		D65

CODICE	DESCRIZIONE	MANICO	PAGINA
0291-1F	Leve per radici · Mini Friedman		D59
0291-2F	Leve per radici · Mini Friedman		D59
0294-1	Mini-leve per frammenti di radici · Warwick-James		D66
0294-2	Mini-leve per frammenti di radici · Warwick-James		D66
0294-3	Mini-leve per frammenti di radici · Warwick-James		D66
0295-1	Sindesmotomi · Chompret		D67
0295-2	Sindesmotomi · Chompret		D67
0295-3	Sindesmotomi · Chompret		D67
0295-4	Sindesmotomi · Chompret		D67
0296-0	Sindesmotomi · punta		D68
0296-1	Sindesmotomi · punta		D68
0296-2	Sindesmotomi · punta		D68
0296-3	Sindesmotomi · punta		D68
0296-4	Sindesmotomi · punta		D68
0296-5	Sindesmotomi · punta		D68
0296-6	Sindesmotomi · punta		D68
0296-7	Sindesmotomi · punta		D68
0296-8	Sindesmotomi · punta		D68
0296-9	Sindesmotomi · punta		D68
0296-11	Sindesmotomi · punta		D68
0296-21	Sindesmotomi · punta		D68
0296-22	Sindesmotomi · punta		D69
0296-23	Sindesmotomi · punta		D69
0296-24	Sindesmotomi · punta		D69
0296-25	Sindesmotomi · punta		D69
0296-26	Sindesmotomi · punta		D69
0296-27	Sindesmotomi · punta		D69
0296-28	Sindesmotomi · punta		D69
0296-29	Sindesmotomi · punta		D69
0296-M	Sindesmotomi · manico		D68
0297-1	Kit di Sindesmotomi		D71
0300-1	Forbicine per gengive · rette		C3, F47, L28
0300-2	Forbicine per gengive · curve		C3, L28
0301-1	Forbicine per gengive · angolari		C3
0301-2	Forbicine per gengive · angolari, una punta dentata		C3
0302-1	Forbicine per gengive · curve · Neumann		C7
0303-1	Forbicine per gengive · punte curve e sottili · Noyes (Castroviejo)		C7
0304-1	Forbicine per gengive · rette, una punta dentata · Goldman-Fox		C3, E4
0304-1TC	Forbicine per gengive · rette · Goldman-Fox		C4
0304-2	Forbicine per gengive · curve, una punta dentata · Goldman-Fox		C3, E4
0304-2TC	Forbicine per gengive · curve · Goldman-Fox		C4
0304-3	Forbicine per gengive · curve, una punta dentata · Goldman-Fox (special)		C4
0305-1	Forbicine per gengive · rette · Iris		C4
0305-1TC	Forbicine per gengive · rette · Iris		C4
0305-2	Forbicine per gengive · curve · Iris		C4
0305-2TC	Forbicine per gengive · rette · Iris		C4
0305-3	Forbicine per gengive · curve · Iris		C5
0306-1	Forbicine per gengive · curve, una punta dentata · Dean		C7
0306-1TC	Forbicine per gengive · curve · Goldman-Fox		C4
0307-1	Forbicine per gengive · curve, una punta dentata · La Grange		C7
0308-1	Forbicine per gengive · rette · Quinby		C5
0308-2	Forbicine per gengive · curve · Quinby		C5
0309-1	Forbicine per gengive · rette · Kelly		C5
0309-1TC	Forbicine per gengive · rette · Kelly		C5, E4
0309-2	Forbicine per gengive · curve · Kelly		C5
0309-2TC	Forbicine per gengive · curve · Kelly		C5, E4
0310-1	Forbicine per gengive · angolari, una punta dentata · Locklin		C6
0310-1TC	Forbicine per gengive · angolari · Locklin		C6
0310-2	Forbicine per gengive · angolari, una punta dentata · Locklin		C6
0310-2TC	Forbicine per gengive · angolari · Locklin		C6
0311-1	Forbicine per gengive · rette, una punta dentata · Sullivan		C6
0311-2	Forbicine per gengive · curve, una punta dentata · Sullivan		C6
0312-1	Forbicine per gengive · curve, punte acute · Westcott		C7, G19
0312-2	Forbicine per gengive · curve, punte arrotondate · Westcott		C7
0313-1	Forbicine per gengive · curve, punte molto sottili		C7

CODICE	DESCRIZIONE	MANICO	PAGINA
0320-1	Forbicine per gengive per sutura · Spencer		C8
0320-2	Forbicine per gengive per sutura · Spencer		C8
0321-1	Forbicine per gengive per separazioni · rette · Metzenbaum		C8
0321-2	Forbicine per gengive per separazioni · curve · Metzenbaum		C8
0322-1	Forbicine per gengive per separazioni · rette · Metzenbaum-Delikat		C8, E4
0322-2	Forbicine per gengive per separazioni · curve · Metzenbaum-Delikat		C8, E4
0325-1	Forbicine per gengive per sutura · rette · Mayo		C8
0325-2	Forbicine per gengive per sutura · curve · Mayo		C8
0328-1	Forbicine per gengive per sutura · rette · Stevens		C9
0328-2	Forbicine per gengive per sutura · curve · Stevens		C9
0329-1	Forbicine per gengive per sutura · punte stondate rette · Stevens		C9
0329-2	Forbicine per gengive per sutura · punte stondate curve · Stevens		C9
0330-1	Forbicine per gengive per sutura · rette · Stevens		C9
0330-2	Forbicine per gengive per sutura · curve · Stevens		C9
0335-1	Manici per bisturi · lama orientabile		C24, E9
0350-3	Manici per bisturi · a doppio taglio		C26, E7
0350-3G	Manici per bisturi		C26, E7
0350-5	Manici per bisturi		C26, E8
0350-5A	Manici per bisturi		C26, E8
0350-7	Manici per bisturi		C26, E7
0350-8	Manici per bisturi		C26, E7
0351-10	Lame per bisturi		C26, E8
0351-11	Lame per bisturi		C26, E8
0351-12	Lame per bisturi		C26, E8
0351-12D	Lame per bisturi · a doppio taglio		C26, E8
0351-15	Lame per bisturi		C26, E8
0351-15C	Lame per bisturi		C26, E8
0352	Pinze togli lama		C24, E9
0360-4	Manici per bisturi		C27
0361-20	Lame per bisturi		C27
0361-21	Lame per bisturi		C27
0361-22	Lame per bisturi		C27
0361-23	Lame per bisturi		C27
0361-24	Lame per bisturi		C27
0365-1	Micro lame		C27, E9, G16
0366-4	Micro lame		C27, E9
0366-7	Micro lame		C27, E9
0371-10	Bisturi monouso		C25, E10
0371-11	Bisturi monouso		C25, E10
0371-12	Bisturi monouso		C25, E10
0371-15	Bisturi monouso		C25, E10
0400-14	Porta aghi · con forbice · Olsen-Hegar		C10
0401-12	Porta aghi · Derf		C13
0403-17	Porta aghi · Adson		C10
0404-14	Porta aghi · Baumgartner		C11
0405-14TC	Porta aghi · Olsen-Hegar		C10
0406-12TC	Porta aghi · Derf		C13
0407-13TC	Porta aghi · punte lisce · Halsey-Smooth		C13
0408-13TC	Porta aghi · Halsey		C13
0409-14TC	Porta aghi · Hegar-Baumgartner		C11
0410-15	Porta aghi · Crile-Wood		C10
0414-16	Porta aghi · con forbice · Gillies		C14
0415-15TC	Porta aghi · Crile-Wood		C10
0416-15TC	Porta aghi · Mini-Ryder		C13
0416-18TC	Porta aghi · Mini-Ryder		C13
0417-15TC	Porta aghi · Fine Swedish		C14
0418-15TC	Porta aghi · Micro-Vascular		C14
0419-16TC	Porta aghi · con forbice · Gillies		C14
0420-16	Porta aghi · Mayo-Hegar		C12
0420-18	Porta aghi · Mayo-Hegar		C12
0421-18	Porta aghi · modello leggero · Toennis		C14
0422-19	Porta aghi · Eiselberg-Mathieu		C15
0425-16TC	Porta aghi · Mayo-Hegar		C12
0425-18TC	Porta aghi · Mayo-Hegar		C12
0426-18TC	Porta aghi · modello leggero · Toennis		C14

CODICE	DESCRIZIONE	MANICO	PAGINA
0430-14	Porta aghi · Mathieu		C16
0430-17	Porta aghi · Mathieu		C16
0431-14	Porta aghi · Mathieu		C16
0431-17	Porta aghi · Mathieu		C16
0432-14	Porta aghi · con forbice · Mathieu		C16
0432-14TC	Porta aghi · Mathieu		C16
0432-17	Porta aghi · movimento leggero · Lichtenberg		C15
0433-16	Porta aghi · Arruga		C15
0435-14TC	Porta aghi · Mathieu		C17, E5
0435-17TC	Porta aghi · Mathieu		C17, E5
0436-14TC	Porta aghi · Mathieu		C17
0436-17TC	Porta aghi · Mathieu		C17
0437-17TC	Porta aghi · Lichtenberg		C15, E5
0438-16TC	Porta aghi · Arruga		C15
0440TH-14	Porta aghi · Castroviejo		C18
0440TH-18	Porta aghi · Castroviejo		C19
0441TH-14	Porta aghi · punte curve · Castroviejo		C18
0441TH-18	Porta aghi · punte curve · Castroviejo		C19
0442TH-13	Porta aghi · Castroviejo		C19
0442TH-13L	Porta aghi · punte lisce · Castroviejo		C19
0443TH-14	Porta aghi · Castroviejo		C18
0444TH-12L	Porta aghi · punte lisce · Castroviejo-Barraquer		C19
0445TH-14TC	Porta aghi · Castroviejo		C18, E5, G19
0445TH-18TC	Porta aghi · Castroviejo		C19
0446TH-14TC	Porta aghi · Castroviejo		C18, E5
0446TH-18TC	Porta aghi · Castroviejo		C19
0447TH-13TC	Porta aghi · Castroviejo		C19
0448TH-14TC	Porta aghi · Castroviejo		C18, E5
0450TH-18TC	Porta aghi · Micro-Barraquer		C17, E6
0451TH-18TC	Porta aghi · punte curve · Micro-Barraquer		C17, E6
0480-1	Siringhe · puntale a cavatappi, filettatura metrico decimale		C29
0480-2	Siringhe · puntale a cavatappi, filettatura metrico decimale		C29
0480-3	Siringhe · puntale a cavatappi, filettatura metrico decimale		C29
0480-4	Siringhe · puntale a cavatappi, filettatura metrico decimale		C29
0480-4W	Siringhe · puntale a cavatappi, filettatura Whitworth		C29
0480-5	Siringhe · autoaspirante, filettatura metrico decimale		C28
0480-6	Siringhe · autoaspirante, filettatura metrico decimale		C28
0480-P1	Siringhe · puntale di ricambio, filettatura metrico decimale		C29
0480-P2	Siringhe · puntale di ricambio, filettatura Whitworth		C29
0481-7	Siringhe · intraligamentale, filettatura metrico decimale		C30
0481-8	Siringhe · intraligamentale, filettatura metrico decimale		C30
0481-T1	Siringhe · protezione in plastica autoclavabile		C30
0482-1	Siringhe · base di appoggio per siringhe		C30
0482-3W	Siringhe · non autoaspirante, filettatura Whitworth		C28
0482-4W	Siringhe · non autoaspirante, filettatura Whitworth		C28
0482-6W	Siringhe · autoaspirante, filettatura Whitworth		C28
0482-7W	Siringhe · intraligamentale, filettatura Whitworth		C30
0483-1	Siringhe · autoaspirante, filettatura metrico decimale		C28
0483-2	Siringhe · non autoaspirante, filettatura metrico decimale		C28
0483-3	Siringhe · non autoaspirante, filettatura metrico decimale		C28
0490-1	Iniettori per osso		E27
0490-2	Iniettori per osso		E27
0491-1	Spessimetri per osso		E31
0491-2	Spessimetri per osso		E31
0493-1	Cannule per aspirazione		E33
0493-2	Filtri per cannule aspirazione		E33
0493-5	Cannule per aspirazione		E33
0494-1	Raschietti per osso · retto		E28
0494-1R	Raschietti per osso · retto		E28
0494-2	Raschietti per osso · curvo		E28
0494-2R	Raschietti per osso · retto		E28
0495-1	Osteotomi		E19
0495-2	Osteotomi		E19
0495-3	Osteotomi		E19
0495-4	Osteotomi		E19

CODICE	DESCRIZIONE	MANICO	PAGINA
0495-5	Osteotomi		E19
0495-6	Osteotomi		E19
0496-1P	Osteotomi		E20
0496-2P	Osteotomi		E20
0496-3P	Osteotomi		E20
0496-4P	Osteotomi		E20
0497-1T	Osteotomi		E20
0497-2T	Osteotomi		E20
0497-3T	Osteotomi		E20
0498-1B3	Osteotomi		E18
0498-1B33	Osteotomi		E18
0498-1B4	Osteotomi		E18
0498-1B5	Osteotomi		E18
0498-2C3	Osteotomi		E18
0498-2C33	Osteotomi		E18
0498-2C4	Osteotomi		E18
0498-2C5	Osteotomi		E18
0498-30B3	Osteotomi		E18
0498-30B33	Osteotomi		E18
0498-30B4	Osteotomi		E18
0498-30B5	Osteotomi		E18
0498-PF3	Osteotomi		E18
0498-PF33	Osteotomi		E18
0498-PF4	Osteotomi		E18
0498-PF5	Osteotomi		E18
0500-1	Pinze emostatiche · rette · Halstead-Mosquito		C21, F46
0500-2	Pinze emostatiche · curve · Halstead-Mosquito		C21, G19
0501-1	Pinze emostatiche · rette · Micro-Mosquito		C22, F46
0501-2	Pinze emostatiche · curve · Micro-Mosquito		C22
0505-1	Pinze emostatiche · rette · Halstead-Mosquito 1x2		C21
0505-2	Pinze emostatiche · curve · Halstead-Mosquito 1x2		C21
0506-1	Pinze emostatiche · rette · Micro-Mosquito 1x2		C22
0506-2	Pinze emostatiche · curve · Micro-Mosquito 1x2		C22
0507-1	Pinzette per elastici · rette · Halstead-Mosquito		I36
0507-2	Pinzette per elastici · curve · Halstead-Mosquito		I36
0510-1	Pinze emostatiche · rette · Kelly		C23, F46
0510-2	Pinze emostatiche · curve · Kelly		C23
0515-1	Pinze emostatiche · rette · Hartmann		C23
0515-2	Pinze emostatiche · curve · Hartmann		C23
0520-1	Pinze emostatiche · rette · Crile		C20
0520-2	Pinze emostatiche · curve · Crile		C20
0530-1	Pinze emostatiche · rette · Kocher 1x2		C20
0530-2	Pinze emostatiche · curve · Kocher 1x2		C20
0540-1	Pinze emostatiche · rette · Pean		C20
0540-2	Pinze emostatiche · curve · Pean		C20
0545-1	Strumenti per corone		L29
0550-1	Pinze per pannilino · Backhaus		C31
0550-2	Pinze per pannilino · Backhaus		C31
0550-3	Pinze per pannilino · Backhaus		C31
0555-1	Pinze porta tamponi · rette · Gross-Maier		C32
0555-2	Pinze porta tamponi · curve · Gross-Maier		C32
0557-1	Pinze porta tamponi · rette · Gross-Maier		C32
0557-2	Pinze porta tamponi · curve · Gross-Maier		C32
0560	Pinze tiralingua · Collin		C33
0561	Pinze tiralingua · Young		C33
0561-R	Pinze tiralingua		C33
0565-1	Pinze per sterilizzazione		J15
0565-2	Pinze per sterilizzazione		J15
0600-2	Pinzette per medicazioni · London-College		B4
0600-3	Pinzette per medicazioni		B5
0600-4	Pinzette per medicazioni · Perry		B4
0600-17	Pinzette per medicazioni		B5
0600-18	Pinzette per medicazioni		B5
0600-18L	Pinzette per medicazioni		B3
0600-19	Pinzette per medicazioni		B5

CODICE	DESCRIZIONE	MANICO	PAGINA
0601-1	Pinzette per medicazioni · Flag		B4
0601-2	Pinzette per medicazioni · London-College		B4
0601-3	Pinzette per medicazioni · Meriam		B4, L19
0601-4	Pinzette per medicazioni · Perry		B4
0601-5	Pinzette per medicazioni · Perry		B4
0602-1	Pinzette per medicazioni		B3
0602-2	Pinzette per medicazioni		B3
0620-1	Pinzette chirurgiche · Adson		C38, E36
0621-1	Pinzette chirurgiche · Adson 1x2		C38, E36
0622-1	Pinzette chirurgiche · Micro-Adson 1x2		C38, G18
0622-2	Pinzette chirurgiche · Micro-Adson 1x2		C39
0623-1	Pinzette chirurgiche		C39
0624-1	Pinzette chirurgiche · Micro-Adson		C39, G18
0624-2	Pinzette chirurgiche · Micro-Adson		C39
0625-1	Pinzette per sutura		C40
0626-1	Pinzette chirurgiche · atraumatiche · Adson Brown		C41
0630-1	Pinzette chirurgiche · Semken-Taylor		C41, E36
0630-2	Pinzette chirurgiche · Semken-Taylor		C41, E36
0631-1	Pinzette chirurgiche · Semken-Taylor 1x2		C41
0631-2	Pinzette chirurgiche · Semken-Taylor 1x2		C41
0635-1	Pinzette chirurgiche		C43
0635-2	Pinzette chirurgiche		C43
0635-3	Pinzette chirurgiche		C43, L19
0635-4	Pinzette chirurgiche		C43, L19
0635-5	Pinzette chirurgiche		C43
0635-6	Pinzette per laboratorio		L19
0645-1	Pinzette chirurgiche		C42
0645-2	Pinzette chirurgiche		C42, L19
0645-3	Pinzette chirurgiche		C42, L19
0645-4	Pinzette chirurgiche		C42
0645-5	Pinzette chirurgiche		C42
0650-1	Pinzette per marcare le tasche · Goldman-Fox (Crane-Kaplan)		B3, E35, H31
0650-2	Pinzette per marcare le tasche · Goldman-Fox (Crane-Kaplan)		B3, E35, H31
0660-1	Pinzette per membrana		E37
0660-2	Pinzette per membrana · con punte ad anello		E37
0661-1	Pinzette porta impianti		E37
0661-2	Pinzette porta impianti		E37
0661-3	Pinzette porta impianti		E37
0670	Pinzette per carta da articolazione · Miller		F44
0671	Pinzette per carta da articolazione		F44
0680	Pinze per pannilino · Schaedle		C31
0681	Pinze per pannilino · Jones		C31
0690	Specchietti ultralight		B21
0690-G	Specchietti ultralight		B21
0690-L	Specchietti ultralight		B21
0690-M	Specchietti ultralight		B21
0690-T	Specchietti ultralight		B21
0691	Divaricatori ultralight		B21
0700-2	Sonde singole	Asa60	B6
0700-3	Sonde singole	Asa60	B6
0700-3A	Sonde singole	Asa60	B6
0700-3R	Sonde singole · Rhein	Asa60	B6
0700-5	Sonde singole	Asa60	B6
0700-6	Sonde singole	Asa60	B6
0700-8	Sonde singole	Asa60	B6
0700-9	Sonde singole	Asa60	B6
0700-10	Sonde singole	Asa60	B6
0700-11	Sonde singole	Asa60	B6
0700-12	Sonde singole	Asa60	B6
0700-16	Sonde singole	Asa60	B6
0700-17	Sonde singole	Asa60	B6
0700-17A	Sonde singole	Asa60	B6
0700-23	Sonde singole	Asa60	B6
0701-2	Sonde singole	Asa60M	B6
0701-3	Sonde singole	Asa60M	B6

CODICE	DESCRIZIONE	MANICO	PAGINA
0701-5	Sonde singole	Asa60M	B6
0701-6	Sonde singole	Asa60M	B6
0701-8	Sonde singole	Asa60M	B6
0701-9	Sonde singole	Asa60M	B6
0701-10	Sonde singole	Asa60M	B6
0701-11	Sonde singole	Asa60M	B6
0701-12	Sonde singole	Asa60M	B6
0701-16	Sonde singole	Asa60M	B6
0701-17	Sonde singole	Asa60M	B6
0701-17A	Sonde singole	Asa60M	B6
0701-23	Sonde singole	Asa60	B6
0701-3A	Sonde singole	Asa60M	B6
0702L-11	Sonde millimetriche parodontali	Asa60	E32, H3
0702L-12	Sonde millimetriche parodontali	Asa60	E32, H3
0702L-12S	Sonde millimetriche parodontali	Asa60	E32, H3
0702L-15	Sonde millimetriche parodontali	Asa60	G17, H3
0702-C	Sonde millimetriche parodontali	Asa35	H3
0703L-1	Sonde millimetriche parodontali · Williams	Asa60	H3
0703L-2	Sonde millimetriche parodontali · Merrit A	Asa60	H3
0703L-3	Sonde millimetriche parodontali · Merrit B	Asa60	H3
0703L-4	Sonde millimetriche parodontali · Goldman-Fox	Asa60	H3
0703L-5	Sonde millimetriche parodontali · University of Michigan	Asa60	H3
0703L-6	Sonde millimetriche parodontali	Asa60	H3
0704-6D9	Sonde doppie	Asa60	B8
0704-11/12AF	Sonde doppie	Asa60	B8
0704-16D1	Sonde doppie	Asa60	B8
0704-16D2	Sonde doppie · Asa Com 2/2B	Asa60	B8, F50
0704-23D1	Sonde doppie	Asa60	B8
0704-23D2	Sonde doppie	Asa60	B8
0704-UT1	Sonde doppie · Cattoni	Asa60	B8
0705L-3GF	Sonde per canali · Goldman-Fox	Asa60	B10
0705L-16GF	Combinazioni Sonde - Sonde millimetriche · Goldman-Fox	Asa60	B10
0705L-16W	Combinazioni Sonde - Sonde millimetriche · Williams	Asa60	B10
0705L-17GF	Combinazioni Sonde - Sonde millimetriche · Goldman-Fox	Asa60	B10
0705L-17UM	Combinazioni Sonde - Sonde millimetriche · University of Michigan	Asa60	B10
0705L-17W	Combinazioni Sonde - Sonde millimetriche · Williams	Asa60	B10
0705L-23GF	Combinazioni Sonde - Sonde millimetriche · Goldman-Fox	Asa60	B10
0705L-23UM	Combinazioni Sonde - Sonde millimetriche · University of Michigan	Asa60	B10
0705L-23W	Combinazioni Sonde - Sonde millimetriche · Williams	Asa60	B10
0706L-2311	Combinazioni Sonde - Sonde millimetriche	Asa60	B10
0706L-2312	Combinazioni Sonde - Sonde millimetriche	Asa60	B10
0707L-GFW	Combinazioni Sonde - Sonde millimetriche · Goldman-Fox Williams	Asa60	B11
0708-1N	Sonde doppie · Nabers	Asa60	B11
0708-2N	Sonde doppie · Nabers	Asa60	B11
0708L-2N	Sonde doppie · Nabers	Asa60	B11
0709-2	Sonde doppie	Asa60	B8
0709-2A	Sonde doppie	Asa60	B8
0709-3	Sonde doppie	Asa60	B9
0710-6D1	Sonde per canali	Asa60	B9
0710-6D2	Sonde per canali	Asa60	B9
0710-6D3	Sonde per canali	Asa60	B9
0800-1	Condensatori per trattamenti canalari	Asa60	B12, G4
0800-2	Condensatori per trattamenti canalari	Asa60	B12, G4
0800-3	Condensatori per trattamenti canalari	Asa60	B12, G4
0800-4	Condensatori per trattamenti canalari	Asa60	B12, G4
0800-5	Condensatori per trattamenti canalari	Asa60	B12, G4
0800-6	Condensatori per trattamenti canalari	Asa60	B12, G4
0800-7	Condensatori per trattamenti canalari	Asa60	B12, G4
0800	Piastra millimetrica per endodonzia		B15, G7
0801-1	Otturatori per canali · Luks	Asa60	B13, G5
0801-2	Otturatori per canali	Asa60	B13, G5
0801-3	Otturatori per canali · Luks	Asa60	B13, G5
0801-4	Otturatori per canali · Luks	Asa60	B13, G5
0802L-1	Otturatori per canali	Asa60	B15, G7
0802L-2	Condensatori	Asa60	B15, G7

CODICE	DESCRIZIONE	MANICO	PAGINA
0802L-3	Condensatori	Asa60	B15, G7
0802L-4	Condensatori	Asa60	B15, G7
0870-1	Pinze per togliere tiranervi rotti		G2
0870-2	Pinze per togliere tiranervi rotti		G2
0900-1	Spatole per cemento		F25
0900-2	Spatole per cemento		F25
0903-0	Spatole per cemento		F25
0903-00	Spatole per cemento		F25
0903-1	Spatole per cemento		F25
0903-2	Spatole per cemento		F25
0903-3	Spatole per cemento		F25
0903-4	Spatole per cemento		F25
0999-1	Piastra in vetro per miscelazione		F25
1009-1	Spingi amalgama · retto, per retrograde		F24
1009-2	Spingi amalgama · curvo, per retrograde		F24
1009-3	Spingi amalgama · retto, per retrograde		F24
1009-4	Spingi amalgama · curvo, per retrograde		F24
1011-1	Spingi amalgama · small		F23
1011-2	Spingi amalgama · medium		F23
1011-3	Spingi amalgama · large		F23
1011-4	Spingi amalgama · jumbo		F23
1015-1	Spingi amalgama · medium/small		F23
1015-2	Spingi amalgama · medium/large		F23
1015-3	Spingi amalgama · medium/jumbo		F23
1020-1	Spingi amalgama · curvo		F24
1020-2	Spingi amalgama · 45°		F24
1020-2P	Spingi amalgama		F24
1020-3	Spingi amalgama · 90°		F24
1030-1	Mortai per amalgama		F23
1030-2	Mortai per amalgama		F23
1030-3	Mortai per amalgama		F23
1030-4	Mortai per osso		E32
1100-1	Spatole Heidemann		F26
1100-2	Spatole Heidemann		F26
1100-3	Spatole Heidemann		F26
1101-1	Spatole Heidemann		F26
1101-2	Spatole Heidemann		F26
1101-3	Spatole Heidemann		F26
1102-1	Spatole Heidemann	Asa60	F27
1102T-1	Spatole Heidemann · con punte rivestite al nitruro di titanio	Asa60	F27
1102-2	Spatole Heidemann	Asa60	F27
1102T-2	Spatole Heidemann · con punte rivestite al nitruro di titanio	Asa60	F27
1102-3	Spatole Heidemann	Asa60	F27
1102T-3	Spatole Heidemann · con punte rivestite al nitruro di titanio	Asa60	F27
1200-1	Otturatori per amalgama	Asa60	F29
1200T-1	Otturatori per amalgama · con punte rivestite al nitruro di titanio	Asa60	F28
1200-2	Otturatori per amalgama	Asa60	F29
1200T-2	Otturatori per amalgama · con punte rivestite al nitruro di titanio	Asa60	F28
1200-3	Otturatori per amalgama	Asa60	F29
1200T-3	Otturatori per amalgama · con punte rivestite al nitruro di titanio	Asa60	F28
1200-4	Otturatori per amalgama	Asa60	F29
1200-5	Otturatori per amalgama	Asa60	F29
1201-1	Otturatori per amalgama	Asa60	F29
1201-1L	Otturatori per amalgama · Asa Com 9/9B	Asa60	F29, F51
1201-2	Otturatori per amalgama	Asa60	F29
1201-2L	Otturatori per amalgama · Asa Com 10/10B	Asa60	F29, F51
1201-3	Otturatori per amalgama	Asa60	F29
1201-3L	Otturatori per amalgama	Asa60	F29
1202-1	Otturatori per amalgama	Asa60	F30
1202-1L	Otturatori per amalgama	Asa60	F30
1202T-1	Otturatori per amalgama · con punte rivestite al nitruro di titanio	Asa60	F28
1202-2	Otturatori per amalgama	Asa60	F30
1202-2L	Otturatori per amalgama	Asa60	F30
1202T-2	Otturatori per amalgama · con punte rivestite al nitruro di titanio	Asa60	F28
1202-3	Otturatori per amalgama	Asa60	F30

CODICE	DESCRIZIONE	MANICO	PAGINA
1202-3L	Otturatori per amalgama	Asa60	F30
1202-4	Otturatori per amalgama	Asa60	F30
1202-4L	Otturatori per amalgama	Asa60	F30
1203-1	Otturatori per amalgama · Asa Com 3/3B	Asa60	F30, F50
1203-2	Otturatori per amalgama	Asa60	F30
1203-3	Otturatori per amalgama · Asa Com 4/4B	Asa60	F30, F50
1204-1	Otturatori - Brunitori · Westcott	Asa60	F34
1204T-1	Otturatori per amalgama · con punte rivestite al nitruro di titanio · Westcott	Asa60	F28
1204-2	Otturatori - Brunitori · Westcott	Asa60	F34
1205-1	Otturatori per amalgama · Ward	Asa60	F31
1205-2	Otturatori per amalgama · Ward	Asa60	F31
1206-1	Strumenti per otturazioni plastiche	Asa60	F36
1206-2	Strumenti per otturazioni plastiche	Asa60	F36
1207-1	Strumenti per otturazioni plastiche	Asa60	F36
1207-2	Strumenti per otturazioni plastiche	Asa60	F36
1208-1	Strumenti per otturazioni plastiche	Asa60	F36
1208T-1	Strumenti per otturazioni plastiche · con punte rivestite al nitruro di titanio	Asa60	F35
1208-2	Strumenti per otturazioni plastiche	Asa60	F36
1208T-2	Strumenti per otturazioni plastiche · con punte rivestite al nitruro di titanio	Asa60	F35
1208-3	Strumenti per otturazioni plastiche	Asa60	F36
1208T-3	Strumenti per otturazioni plastiche · con punte rivestite al nitruro di titanio	Asa60	F35
1209-1	Strumenti per otturazioni plastiche	Asa60	F36
1209-2	Strumenti per otturazioni plastiche	Asa60	F36
1209T-2	Strumenti per otturazioni plastiche · con punte rivestite al nitruro di titanio	Asa60	F35
1209-3	Strumenti per otturazioni plastiche	Asa60	F36
1210-1	Strumenti per composito · Asa Com 14/14B	Asa60	F37, F52
1210-2	Strumenti per otturazioni plastiche	Asa60	F37
1210T-2	Strumenti per otturazioni plastiche · con punte rivestite al nitruro di titanio	Asa60	F35
1210-3	Strumenti per otturazioni plastiche · Asa Com 15/15B	Asa60	F37, F52
1211-OT	Otturatori per amalgama · Tanner	Asa60	F31
1211-1T	Otturatori per amalgama · Tanner	Asa60	F31
1211-2T	Otturatori per amalgama · Tanner	Asa60	F31
1211-3T	Otturatori per amalgama · Tanner	Asa60	F31
1212-01	Otturatori per amalgama · Marquette	Asa60	F31
1213-H1	Otturatori per amalgama · Hollenback	Asa60	F31
1213-H2	Otturatori per amalgama · Hollenback	Asa60	F31
1213-H3	Otturatori per amalgama · Asa Com 12/12B · Hollenback	Asa60	F31, F51
1213-H4	Otturatori per amalgama · Hollenback	Asa60	F31
1214-2	Otturatori - Brunitori · Ladmore	Asa60	F34
1214-3	Otturatori - Brunitori · Ladmore	Asa60	F34
1214-A	Otturatori - Brunitori	Asa60	F34
1215-18	Otturatori - Brunitori · Ball	Asa60	F34
1215-27S	Otturatori - Brunitori · Ball	Asa60	F34
1215-29	Otturatori - Brunitori · Ball	Asa60	F34
1215-W3	Otturatori - Brunitori	Asa60	F34
1216-1	Strumenti per otturazioni plastiche · Woodson	Asa60	F37
1216-2	Strumenti per otturazioni plastiche · Woodson	Asa60	F37
1216-3	Strumenti per otturazioni plastiche · Woodson	Asa60	F37
1217-11	Strumenti per otturazioni plastiche	Asa60	F37
1218-6	Strumenti per otturazioni plastiche	Asa60	F37
1219-179	Strumenti per otturazioni plastiche · Asa Com 5/5B	Asa60	F37, F50
1220-B2	Otturatori - Brunitori · Asa Com 8/8B · New York Univeristy	Asa60	F34, F51
1221-31	Otturatori - Brunitori	Asa60	F34
1300	Applicatori per sottofondo	Asa35	F41
1301	Applicatori per sottofondo	Asa60	F41
1302	Applicatori per sottofondo	Asa60	F41
1303	Strumenti per l'applicazione di tinture e medicinali · Orban Loop	Ottagonali	F41
1310-1	Strumenti per filo retrattore	Asa60	F40
1310-2	Strumenti per filo retrattore	Asa60	F40
1350-1	Strumenti per legature · per montare e rimuovere bande		I35
1350-2	Strumenti per legature · per montare e rimuovere bande		I35
1351-1	Strumenti per legature · per montare e rimuovere bande		I35
1352-1	Strumento per elastici		I35
1355-1	Porta tamponi · per legature elastiche · Luniatschek	Ottagonali	F41, I36
1355-2	Porta tamponi · per legature elastiche · Luniatschek	Ottagonali	F41, I36

CODICE	DESCRIZIONE	MANICO	PAGINA
1400-1	Otturatori per amalgama · Markley	Asa60	F32
1400-2	Otturatori per amalgama · Markley	Asa60	F32
1400-3	Otturatori per amalgama · Markley	Asa60	F32
1400-4	Otturatori per amalgama · Markley	Asa60	F32
1400-5	Otturatori per amalgama · Markley	Asa60	F32
1400-6	Otturatori per amalgama · Markley	Asa60	F32
1401-0	Otturatori per amalgama · Foc	Asa60	F33
1401-1	Otturatori per amalgama · Asa Com 11/11B · Foc	Asa60	F33, F51
1401-2	Otturatori per amalgama · Foc	Asa60	F33
1401-0S	Otturatori per amalgama · Foc	Asa60	F33
1401-1S	Otturatori per amalgama · Foc	Asa60	F33
1401-2S	Otturatori per amalgama · Foc	Asa60	F33
1500-02	Strumenti per modellare amalgama/cera · Hollenback	Asa60	F38, L13
1500-3	Strumenti per modellare amalgama/cera · Hollenback	Asa60	F38, L13
1500-3S	Strumenti per modellare amalgama/cera · Hollenback	Asa60	F38, L13
1501-1	Strumenti per modellare amalgama/cera · Ward	Asa60	F38, L13
1501-1S	Strumenti per modellare amalgama/cera · Ward	Asa60	F38, L13
1501-2	Strumenti per modellare amalgama/cera · Ward	Asa60	F38, L13
1502-1	Strumenti per modellare amalgama/cera · Frahm	Asa60	F39, L13
1503-2	Strumenti per modellare amalgama/cera · USC	Asa60	F39, L13
1504-1	Strumenti per modellare · interprossimale	Asa60	F39
1504-2	Strumenti per modellare · interprossimale Off-angle · Asa Com 6/6B	Asa60	F39, F50
1505-3	Strumenti per modellare	Asa60	F39
1505-A	Strumenti per modellare	Asa60	F39
1506-104	Strumenti per modellare	Asa60	F39
1507-8	Strumenti per modellare · Wiland	Asa60	F39
1600-1	Strumenti per modellare · cleoide-discoide	Asa60	F40
1600-2	Strumenti per modellare · cleoide-discoide	Asa60	F40
1600-3	Strumenti per modellare · cleoide-discoide	Asa60	F40
1600-4	Strumenti per modellare · cleoide-discoide	Asa60	F40
1601-1	Strumenti per preparazione cavità - finitori per bordi gengivali · distale · Black/26	Asa60	F21
1601-2	Strumenti per preparazione cavità - finitori per bordi gengivali · mesiale · Black/27	Asa60	F21
1601-3	Strumenti per preparazione cavità - finitori per bordi gengivali · distale · Black/28	Asa60	F21
1601-4	Strumenti per preparazione cavità - finitori per bordi gengivali · mesiale · Black/29	Asa60	F21
1602-1	Strumenti per preparazione cavità - finitori per bordi gengivali · distale · Black/77-78	Asa60	F21
1602-2	Strumenti per preparazione cavità - finitori per bordi gengivali · mesiale · Black/79-80	Asa60	F21
1603-1	Strumenti per preparazione cavità - scalpelli · Black/53-54	Asa60	F22
1603-2	Strumenti per preparazione cavità - scalpelli · Black/51-52	Asa60	F22
1604-02	Strumenti per preparazione cavità - scalpelli · Wedelstaedt	Asa60	F22
1604-04	Strumenti per preparazione cavità - scalpelli · Wedelstaedt	Asa60	F22
1604-06	Strumenti per preparazione cavità - scalpelli · Wedelstaedt	Asa60	F22
1700-0	Escavatori - cucchiali	Asa60	F16
1700-1	Escavatori - cucchiali ovali	Asa60	F16
1700-2	Escavatori - cucchiali	Asa60	F16
1700-3	Escavatori - cucchiali	Asa60	F16
1700-4	Escavatori - cucchiali	Asa60	F16
1701-1	Escavatori - cucchiali	Asa60	F16
1701-2	Escavatori - cucchiali	Asa60	F16
1702-6	Escavatori - cucchiali	Asa60	F17
1703-14	Escavatori - cucchiali	Asa60	F17
1704-17	Escavatori - cucchiali	Asa60	F17
1704-17W	Escavatori - cucchiali ovali	Asa60	F18
1705-18	Escavatori - cucchiali	Asa60	F17
1705-18W	Escavatori - cucchiali ovali	Asa60	F18
1706-19	Escavatori - cucchiali	Asa60	F17
1706-19W	Escavatori - cucchiali ovali	Asa60	F18
1707-39	Escavatori - cucchiali	Asa60	F17
1709-31L	Escavatori canalari	Asa60	B15, F17
1709-32L	Escavatori canalari	Asa60	B15, F17
1709-33L	Escavatori canalari	Asa60	B15, F17
1710-5	Escavatori · SS. White	Asa60	F19
1710-14	Escavatori · SS. White	Asa60	F19
1710-17	Escavatori · SS. White	Asa60	F19
1710-18	Escavatori · SS. White	Asa60	F19
1710-19	Escavatori · SS. White	Asa60	F19

CODICE	DESCRIZIONE	MANICO	PAGINA
1710-20	Escavatori - SS. White	Asa60	F19
1711-1	Escavatori - Darby-Perry	Asa60	F20
1711-2	Escavatori - Darby-Perry	Asa60	F20
1711-11	Escavatori - Darby-Perry	Asa60	F20
1711-12	Escavatori - Darby-Perry	Asa60	F20
1711-21	Escavatori - Darby-Perry	Asa60	F20
1711-22	Escavatori - Darby-Perry	Asa60	F20
1711-31	Escavatori - Darby-Perry	Asa60	F20
1711-32	Escavatori - Darby-Perry	Asa60	F20
1711-41	Escavatori - Darby-Perry	Asa60	F20
1711-42	Escavatori - Darby-Perry	Asa60	F20
1711-243	Escavatori - ASH	Asa60	F18
1711-G2	Escavatori - ASH	Asa60	F18
1800-1	Scalpellini e sgorbie per parodontologia - Ochsenbein		H27
1800-2	Scalpellini e sgorbie per parodontologia - Ochsenbein		H27
1801-1	Scalpellini chirurgici - TG	Asa60	H26
1801-2	Scalpellini chirurgici - TG	Asa60	H26
1801-D	Scalpellini chirurgici - TG	Asa60	H26
1802-3	Scalpellini chirurgici - Ochsenbein	Asa60	H26
1802-4	Scalpellini chirurgici - Ochsenbein	Asa60	H26
1803-1	Bisturi per gengivectomia - Kirkland	Asa60	H24
1803-2	Bisturi per gengivectomia - Kirkland	Asa60	H24
1803-D	Bisturi per gengivectomia - Kirkland	Asa60	H24
1804-1	Bisturi per gengivectomia - Orban	Asa60	H24
1804-2	Bisturi per gengivectomia - Orban	Asa60	H24
1804-D	Bisturi per gengivectomia - Orban	Asa60	H24
1805-02	Curette e Scaler - Langer	Asa60	H5
1805-04	Curette e Scaler - Langer	Asa60	H5
1806-02	Curette e Scaler	Asa60	H4
1806-2RL	Curette e Scaler - Columbia	Asa60	H4
1806-4RL	Curette e Scaler - Columbia	Asa60	H4
1806-14	Curette e Scaler - Columbia	Asa60	H4
1806-412	Curette e Scaler - Columbia	Asa60	H4
1806-414	Curette e Scaler - Columbia	Asa60	H4
1807-02	Curette Gracey	Asa60	H11
1807-02AF	Curette Gracey - AF	Asa60	H12
1807-02MF	Curette Gracey - MF	Asa60	H13
1807-04	Curette Gracey	Asa60	H11
1807-04AF	Curette Gracey - AF	Asa60	H12
1807-04MF	Curette Gracey - MF	Asa60	H13
1807-06	Curette Gracey	Asa60	H11
1807-06AF	Curette Gracey - AF	Asa60	H12
1807-06MF	Curette Gracey - MF	Asa60	H13
1807-08	Curette Gracey	Asa60	H11
1807-08AF	Curette Gracey - AF	Asa60	H12
1807-08MF	Curette Gracey - MF	Asa60	H13
1807-10	Curette Gracey	Asa60	H11
1807-11MD	Curette Gracey - mesiale-distale	Asa60	H11
1807-12	Curette Gracey	Asa60	H11
1807-12AF	Curette Gracey - AF	Asa60	H12
1807-12MF	Curette Gracey - MF	Asa60	H13
1807-13MD	Curette Gracey - mesiale-distale	Asa60	H11
1807-14	Curette Gracey	Asa60	H11
1807-14AF	Curette Gracey - AF	Asa60	H12
1807-14MF	Curette Gracey - MF	Asa60	H13
1807-16	Curette Gracey	Asa60	H11
1807-16AF	Curette Gracey - AF	Asa60	H12
1807-16MF	Curette Gracey - MF	Asa60	H13
1807-18	Curette Gracey	Asa60	H11
1808-1	Curette e Scaler - De Marco	Asa60	H5
1808-2	Curette e Scaler - De Marco	Asa60	H5
1809-1	Curette e Scaler - Goldman-Fox	Asa60	H6
1809-2	Curette e Scaler - Goldman-Fox	Asa60	H6
1809-3	Curette e Scaler - Goldman-Fox	Asa60	H6
1809-4	Curette e Scaler - Goldman-Fox	Asa60	H6

CODICE	DESCRIZIONE	MANICO	PAGINA
1809-5	Curette e Scaler - Goldman-Fox	Asa60	H6
1809-6	Curette e Scaler - Goldman-Fox	Asa60	H6
1809-21	Curette e Scaler - Goldman-Fox	Asa60	H6
1810-07	Lime - Hirschfeld	Asa60	H22
1811-37	Scalpellini chirurgici - back-action - Rhodes	Asa60	H26
1812-02S	Lime - Sugarman	Asa60	H22
1812-04S	Lime - Sugarman	Asa60	H22
1813-10	Lime - Schluger	Asa60	H22
1815-7	Bisturi per gengivectomia - Goldman-Fox	Asa60	H25
1815-8	Bisturi per gengivectomia - Goldman-Fox	Asa60	H25
1815-9	Bisturi per gengivectomia - Goldman-Fox	Asa60	H25
1815-11	Bisturi per gengivectomia - Goldman-Fox	Asa60	H25
1816-04	Bisturi per gengivectomia - Buck	Asa60	H25
1816-06	Bisturi per gengivectomia - Buck	Asa60	H24
1817-02	Bisturi per gengivectomia - Sanders	Asa60	H25
1817-05	Bisturi per gengivectomia - Sanders	Asa60	H25
1818-20	Bisturi per gengivectomia - USC Towner (University of South California)	Asa60	H25
1819-CK3	Bisturi per gengivectomia - Crane-Kaplan	Asa60	H25
1820-Z	Curette e Scaler - Zerfing-Chisel	Asa60	H4
1821-02	Curette e Scaler - Barnhart	Asa60	H5
1821-06	Curette e Scaler - Barnhart	Asa60	H5
1822-ME1	Curette e Scaler	Asa60	H5
1823-R04	Curette e Scaler - Rule	Asa60	H5
1824-14	Curette e Scaler - anteriore - Indiana University	Asa60	H5
1824-18	Curette e Scaler - posteriore - Indiana University	Asa60	H5
1825-12	Curette e Scaler - Mc Call	Asa60	H7
1825-14	Curette e Scaler - Mc Call	Asa60	H7
1825-20	Curette e Scaler - Mc Call	Asa60	H7
1825-12A	Curette e Scaler - Mc Call	Asa60	H7
1825-14S	Curette e Scaler - Mc Call	Asa60	H7
1825-18S	Curette e Scaler - Mc Call	Asa60	H7
1826-T03	Curette e Scaler - Taylor	Asa60	H8
1827-204	Curette e Scaler	Asa60	H8
1827-204S	Curette e Scaler	Asa60	H8
1829-CK6	Curette e Scaler - Crane-Kaplan	Asa60	H8
1829-CK6S	Curette e Scaler - Mini Crane-Kaplan	Asa60	H8
1830-YG08	Curette e Scaler - Younger-Good	Asa60	H8
1831-32	Curette e Scaler - Jacqueline	Asa60	H9
1831-33	Curette e Scaler - Jacqueline	Asa60	H9
1831-35	Curette e Scaler - Jacqueline	Asa60	H9
1831-38	Curette e Scaler - Jacqueline	Asa60	H9
1832-1	Scalpellini e sgorbie per parodontologia - Gardner		H27
1832-2	Scalpellini e sgorbie per parodontologia - Gardner		H27
1832-5	Scalpellini e sgorbie per parodontologia - Gardner		H27
1832-5R	Scalpellini e sgorbie per parodontologia - Gardner		H27
1832-6	Scalpellini e sgorbie per parodontologia - Gardner		H27
1833-1W	Scalpellini e sgorbie per parodontologia - Wakefield		H27
1833-2W	Scalpellini e sgorbie per parodontologia - Wakefield		H27
1834-3	Scalpellini e sgorbie per parodontologia - Buckley		H27
1835-3	Scalpellini e sgorbie per parodontologia - Partsch		H28
1835-4	Scalpellini e sgorbie per parodontologia - Partsch		H28
1835-5	Scalpellini e sgorbie per parodontologia - Partsch		H28
1835-6	Scalpellini e sgorbie per parodontologia - Partsch		H28
1836-3	Scalpellini e sgorbie per parodontologia - Partsch		H28
1836-4	Scalpellini e sgorbie per parodontologia - Partsch		H28
1836-5	Scalpellini e sgorbie per parodontologia - Partsch		H28
1836-6	Scalpellini e sgorbie per parodontologia - Partsch		H28
1837-3	Scalpellini e sgorbie per parodontologia - Partsch		H28
1837-4	Scalpellini e sgorbie per parodontologia - Partsch		H28
1837-5	Scalpellini e sgorbie per parodontologia - Partsch		H28
1837-6	Scalpellini e sgorbie per parodontologia - Partsch		H28
1838-3	Scalpellini e sgorbie per parodontologia - Partsch		H28
1838-4	Scalpellini e sgorbie per parodontologia - Partsch		H28
1838-5	Scalpellini e sgorbie per parodontologia - Partsch		H28
1838-6	Scalpellini e sgorbie per parodontologia - Partsch		H28

CODICE	DESCRIZIONE	MANICO	PAGINA
1839-1	Scalpelli Freer taglio singolo · Freer		E16
1839-2	Scalpelli Freer taglio singolo · Freer		E16
1839-3	Scalpelli Freer taglio singolo · Freer		E16
1840-1	Scalpelli graduati · retti		E17
1840-2	Scalpelli graduati · curvi		E17
1840-3	Scalpelli graduati · retti		E17
1840-4	Scalpelli graduati · curvi		E17
1844-3	Mucotomi · retti		E26
1844-3C	Mucotomi · curvi		E26
1844-4	Mucotomi · retti		E26
1844-4C	Mucotomi · curvi		E26
1844-5	Mucotomi · retti		E26
1844-5C	Mucotomi · curvi		E26
1844-6	Mucotomi · retti		E26
1844-6C	Mucotomi · curvi		E26
1846	Macinatori per osso		E27
1849-1	Scollaperiostio ed Elevatori · Partsch	Asa60	E24, H17
1855-22	Scollaperiostio ed Elevatori · scollatore · Seldin		E25, H18
1855-23	Scollaperiostio ed Elevatori · scollatore · Seldin		E25, G16, H18
1856-1	Scollaperiostio ed Elevatori · Williger		E25, H19
1856-2	Scollaperiostio ed Elevatori · Williger		E25, H19
1857-1	Scollaperiostio ed Elevatori · Williger		E25, H19
1857-2	Scollaperiostio ed Elevatori · Williger		E25, H19
1858-1	Scollaperiostio ed Elevatori · König		E25, H18
1870-1	Apribocca · Molt		C33
1870-2	Apribocca · Molt		C33
1871-1	Apribocca · Roser-Koenig		C33
1871-2	Apribocca · Roser-Koenig		C33
1880	Martelli chirurgici · Partsch		E16, H29
1881	Martelli chirurgici · Mead		E16, H29
1881-R	Inseriti di ricambio per martelli · Teflon		H29
1882	Martelli chirurgici · Mead		H29
1884	Martelli chirurgici · Vickers		H29
1885	Martelli chirurgici · Herbert		H29
1890-1F	Pietre per affilare · grana fine		H32
1890-1M	Pietre per affilare · grana media		H32
1890-2	Pietre per affilare		H32
1890-3	Pietre per affilare		H32
1890-4	Pietre per affilare		H32
1890-5	Pietre per affilare		H32
1890-6	Pietre per affilare		H33
1890-7	Pietre per affilare		H33
1891-1	Pietre per affilare		H33
1900-1L	Scaler · sinistro	Asa60	H15
1900-1R	Scaler · destro	Asa60	H15
1900-2L	Scaler · sinistro	Asa60	H15
1900-2R	Scaler · destro	Asa60	H15
1900-M23	Scaler · Universal Scaler	Asa60	H14
1901-1	Scaler	Asa60	H15
1902-1	Scaler · Towner Jacqueline	Asa60	H14
1902-2	Scaler · Towner Jacqueline	Asa60	H14
1903	Scaler · Towner	Asa60	H14
1904-H5	Scaler	Asa60	H14
1904-H6	Scaler	Asa60	H14
1905-02	Scaler	Asa60	H14
1906-33	Scaler	Asa60	H15
1909-H5	Scaler	Asa60	H15
1909-H6	Scaler	Asa60	H15
1909-H7	Scaler · Hygienist	Asa60	H15
2000-1	Cucchiari alveolari · Hemingway	Asa60	C45, E21, H20
2000-2	Cucchiari alveolari · Hemingway	Asa60	C45, E21, H20
2000-3	Cucchiari alveolari · Hemingway	Asa60	C45, E21, H20
2000-4	Cucchiari alveolari · Hemingway	Asa60	H20
2001-85	Cucchiari alveolari · Lucas	Asa60	H20
2001-86	Cucchiari alveolari · Lucas	Asa60	H20

CODICE	DESCRIZIONE	MANICO	PAGINA
2001-87	Cucchiari alveolari · Lucas	Asa60	H20
2001-88	Cucchiari alveolari · Lucas	Asa60	H20
2002-6	Specchietto parallelizzatore		B19
2003-1	Lime per alveolotomia · Polokoff	Asa Light MV	H23
2004-33	Lime per alveolotomia	Asa Light MV	H23
2005-45	Lime per alveolotomia · Miller	Asa Light MV	H23
2005-64	Lime per alveolotomia · Miller	Asa Light MV	E21, H23
2006-10	Lime per alveolotomia	Asa Light MV	E21, H23
2007-12A	Lime per alveolotomia	Asa Light MV	H23
2007-12CA	Lime per alveolotomia	Asa Light MV	H23
2008-12	Lime per alveolotomia	Asa Light MV	H23
2013-2	Cucchiari alveolari · modello U.S.A.		H21
2013-2L	Cucchiari alveolari · modello U.S.A.		H21
2013-2R	Cucchiari alveolari · modello U.S.A.		H21
2014-3	Cucchiari alveolari		C45, E21
2015-0	Cucchiari alveolari · Williger		H21
2015-00	Cucchiari alveolari · Williger		H21
2015-1	Cucchiari alveolari · Williger		H21
2016-0	Cucchiari alveolari		H21
2016-00	Cucchiari alveolari		H21
2016-1	Cucchiari alveolari		H21
2100-CS	Manici per specchietti · modello Americano		B20
2101-CS	Manici per specchietti · modello Americano		B20
2102-CS	Manici per specchietti · modello Americano		B20
2104-B	Manici per specchietti		B19
2104-C	Manici per specchietti		B19
2104-G	Manici per specchietti		B19
2104-R	Manici per specchietti		B19
2104-V	Manici per specchietti		B19
2200E-4	Specchietti per bocca		B18
2200E-5	Specchietti per bocca		B18
2200E-6	Specchietti per bocca		B18
2201E-4	Specchietti per bocca		B18
2201E-5	Specchietti per bocca		B18
2210E-4	Specchietti per bocca · modello Americano		B20
2210E-5	Specchietti per bocca · modello Americano		B20
2211E-4	Manici per specchietti · modello Americano		B20
2211E-5	Manici per specchietti · modello Americano		B20
2220E-4	Specchietti per bocca · Rhodium		B18
2220E-5	Specchietti per bocca · Rhodium		B18
2221-4	Specchietti per bocca · Titanium		B18
2221-5	Specchietti per bocca · Titanium		B18
2230-5	Specchietti per bocca		B18
2231-5CS	Specchietti per bocca · modello Americano		B20
2240-1	Specchietti per bocca · Ø 3 mm · piano, micro		B19, G11, G15
2240-2	Specchietti per bocca · Ø 5 mm · piano, micro		B19
2240-3	Specchietti per bocca · 7x2 mm · piano, micro		B19
2240-4	Specchietti per bocca · 9x3 mm · piano, micro		B19
2241-5	Specchietti per bocca · 6x3 mm · piano, micro		B19, G16
2250-1	Specchietti per fotografie · superfici occlusali		B17
2250-2	Specchietti per fotografie · superfici occlusali		B17
2250-3	Specchietti per fotografie · superfici buccali		B17
2250-4	Specchietti per fotografie · superfici linguali		B17
2250-5	Specchietti per fotografie · superfici linguali		B17
2300-D	Martelletti levacorone		F42
2300-S	Martelletti levacorone		F42
2301	Punte per martelletti levacorone		F42
2302	Punte per martelletti levacorone		F42
2305-D	Martelletti levacorone		F42
2306	Punte per martelletti levacorone		F42
2307	Punte per martelletti levacorone		F42
2308	Punte per martelletti levacorone		F42
2320	Strumenti levacorone e apricorone		F43
2331-1	Pinze per togliere anelli di rame · rette · Furrer		F45
2331-2	Pinze per togliere anelli di rame · curve · Furrer		F45

CODICE	DESCRIZIONE	MANICO	PAGINA
2340-0	Apricorone		F43
2340-1	Apricorone		F43
2340-2	Apricorone		F43
2340-3	Apricorone		F43
2400	Pinzette per posizionare attacchi adesivi		I34
2401	Pinzette per posizionare attacchi adesivi		I34
2402	Pinzette per posizionare attacchi adesivi		I34
2410	Spingibande · Mershon		I34
2411	Adattatori di bande		I34
2412	Spingibande · utilizzato in tutti gli sterilizzatori a caldo		I34
2450	Pinza tendielastici · per catenelle e separatori		I35
2500-1	Strumenti per Corone · Böhm		F45, L29
2500-2	Strumenti per Corone · Böhm		F45, L29
2550-1	Calibri · per cera · Iwanson		F44, L30
2550-2	Calibri · per metallo · Iwanson		F44, L30
2555	Calibri · Boley		F44, L30
2556-1	Calibri · alluminio, divisione in millimetri e pollici		L30
2556-2	Calibri · alluminio, divisione in millimetri e pollici · Townley		L30
2556-3	Calibri · Jameson		L30
2556-4	Calibri		E33
2557-1	Calibri		L30
2601	Divaricatori per labbra · Columbia		C34
2602-1	Divaricatori per labbra · Sternberg		C34, E11
2602-2	Divaricatori per labbra · Sternberg		C34
2602-3	Divaricatori per labbra · Sternberg		C34
2604	Divaricatore per guance · University of Minnesota		C34, E12
2605	Abbassalingua		C34
2606	Abbassalingua		C34
2607	Abbassalingua · Buchwald		C34
2608	Abbassalingua · Brünings		C34
2609-2	Divaricatori per labbra · Orringer medium		C34, E11
2611-1	Divaricatori · arrotondato		C35
2611-2	Divaricatori · arrotondato		C35
2613-1	Divaricatori · acuto · Senn-Miller		C35
2613-2	Divaricatori · arrotondato · Senn-Miller		C35
2615-1	Divaricatori · Kilner		C35
2616-1	Divaricatori · Farabeuf		C35
2617-2	Divaricatori · sinistro, acuto · Williger		C35
2617-3	Divaricatori · destro acuto · Williger		C35
2618-1	Divaricatori · retto, acuto · Williger		C35
2618-2	Divaricatori · sinistro, arrotondato · Williger		C35
2620-1	Divaricatori · Middeldorpf		C37, E12
2620-2	Divaricatori · Middeldorpf		C37
2620-3	Divaricatori · Middeldorpf		C37
2621-1	Divaricatori · Langenbeck		C36
2621-2	Divaricatori · Langenbeck		C36
2621-3	Divaricatori · Langenbeck		C36
2621-4	Divaricatori · Langenbeck		C36
2621-5	Divaricatori · Langenbeck		C36
2622-1	Divaricatori · Langenbeck		C36
2622-2	Divaricatori · Langenbeck		C36
2622-3	Divaricatori · Langenbeck		C36
2622-4	Divaricatori · Langenbeck		C36
2622-5	Divaricatori · Langenbeck		C36
2623-1	Divaricatori · Kocher		C36
2623-2	Divaricatori · Kocher		C36
2624-1	Divaricatori · Kocher		C36
2624-2	Divaricatori · Kocher		C36
2625-1	Divaricatori per spina nasale		C36, E12
2626-1	Divaricatori per spina nasale		C36, E12
2627	Divaricatori		C37, E11
2628-1	Divaricatori labiale		C37, E10
2628-2	Divaricatori apribile		E10
2650-02	Sonde seno mascellare · Bowman		C37
2650-08	Sonde seno mascellare · Bowman		C37

CODICE	DESCRIZIONE	MANICO	PAGINA
2651-1	Sonde seno mascellare		C37
2651-2	Sonde seno mascellare		C37
2700-G	Vassoi portastrumenti in acciaio inox · per 7 strumenti		J6
2700-L	Vassoi portastrumenti in acciaio inox · vassoio non forato		J6
2700-U	Vassoi portastrumenti in acciaio inox · coperchio non forato		J6
2702-L	Vassoi portastrumenti in acciaio inox · vassoio forato		J6
2702-U	Vassoi portastrumenti in acciaio inox · coperchio forato		J6
2720-L	Vassoi portastrumenti in acciaio inox · vassoio non forato		J5
2720-U	Vassoi portastrumenti in acciaio inox · coperchio non forato		J4, J5
2721-L	Vassoi portastrumenti in acciaio inox · vassoio forato		J4, J4
2721-U	Vassoi portastrumenti in acciaio inox · coperchio forato		J4
2723-L	Vassoi portastrumenti in acciaio inox · vassoio non forato		J6
2723-U	Vassoi portastrumenti in acciaio inox · coperchio non forato		J6
2724-L	Vassoi portastrumenti in acciaio inox · vassoio non forato		J7
2724-U	Vassoi portastrumenti in acciaio inox · coperchio non forato		J7
2730-1	Vassoi portastrumenti in acciaio inox · per 16 strumenti		J5
2730-2	Vassoi portastrumenti in acciaio inox · per 23 strumenti		J5
2730-3	Kit di strumenti per diga · griglia portastrumenti		F13
2730-4	Vassoi portastrumenti in acciaio inox · per 8 strumenti		J7
2730-5	Vassoi portastrumenti in acciaio inox · per 4 strumenti		J7
2731-1	Kit di strumenti per diga		F14
2737-1	Vaschette in acciaio Inox		J14
2737-2	Vaschette in acciaio Inox		J14
2737-3	Vaschette in acciaio Inox		J14
2737-4	Vaschette in acciaio Inox		J14
2750-1	Distributori per bicchieri		A16
2750-2	Distributori per bicchieri		A16
2751-1	Distributori di palline di cotone in acciaio inox		J21
2770-1	Cassette portastrumenti in acciaio inox · large · per 20 strumenti - Blu		J2
2770-1A	Cassette portastrumenti in acciaio inox · large · per 20 strumenti - Arancio		J2
2770-1MX	Locking tray 20 strumenti (lilla, giallo, verde)		G13, J2
2770-1R	Cassette portastrumenti in acciaio inox · large · per 20 strumenti - Rosso		J2
2770-1V	Cassette portastrumenti in acciaio inox · large · per 20 strumenti - Verde		J2
2770-2	Cassette portastrumenti in acciaio inox · large · per 15 strumenti - Blu		J2
2770-2A	Cassette portastrumenti in acciaio inox · large · per 15 strumenti - Arancio		J2
2770-2R	Cassette portastrumenti in acciaio inox · large · per 15 strumenti - Rosso		J2
2770-2V	Cassette portastrumenti in acciaio inox · large · per 15 strumenti - Verde		J2
2770-3	Cassette portastrumenti in acciaio inox · large · per 10 strumenti - Blu		J2
2770-3A	Cassette portastrumenti in acciaio inox · large · per 10 strumenti - Arancio		J2
2770-3R	Cassette portastrumenti in acciaio inox · large · per 10 strumenti - Rosso		J2
2770-3V	Cassette portastrumenti in acciaio inox · large · per 10 strumenti - Verde		J2
2770-G	Blocca strumenti · per 10 posti - Blu - silicone		J3
2770-GA	Blocca strumenti · per 10 posti - Arancio - silicone		J3
2770-GR	Blocca strumenti · per 10 posti - Rosso - silicone		J3
2770-GV	Blocca strumenti · per 10 posti - Verde - silicone		J3
2771-1	Cassette portastrumenti in acciaio inox · medium · per 10 strumenti - Blu		J2
2771-1A	Cassette portastrumenti in acciaio inox · medium · per 10 strumenti - Arancio		J2
2771-1L	Locking tray 10 strumenti (lilla)		G9, J2
2771-1R	Cassette portastrumenti in acciaio inox · medium · per 10 strumenti - Rosso		J2
2771-1V	Cassette portastrumenti in acciaio inox · medium · per 10 strumenti - Verde		J2
2771-2	Cassette portastrumenti in acciaio inox · medium · per 5 strumenti - Blu		J2
2771-2A	Cassette portastrumenti in acciaio inox · medium · per 5 strumenti - Arancio		J2
2771-2R	Cassette portastrumenti in acciaio inox · medium · per 5 strumenti - Rosso		J2
2771-2V	Cassette portastrumenti in acciaio inox · medium · per 5 strumenti - Verde		J2
2771-G	Blocca strumenti · per 5 posti - Blu - silicone		J3
2771-GA	Blocca strumenti · per 5 posti - Arancio - silicone		J3
2771-GR	Blocca strumenti · per 5 posti - Rosso - silicone		J3
2771-GV	Blocca strumenti · per 5 posti - Verde - silicone		J3
2772-1	Cassette portastrumenti in acciaio inox · mini · per 5 strumenti - Blu		J3
2772-1A	Cassette portastrumenti in acciaio inox · mini · per 5 strumenti - Arancio		J3
2772-1R	Cassette portastrumenti in acciaio inox · mini · per 5 strumenti - Rosso		J3
2772-1V	Cassette portastrumenti in acciaio inox · mini · per 5 strumenti - Verde		J3
2772-G	Rastrelliera · per 10 posti - Blu - silicone		J3
2772-GA	Rastrelliera · per 10 posti - Arancio - silicone		J3
2772-GR	Rastrelliera · per 10 posti - Rosso - silicone		J3

CODICE	DESCRIZIONE	MANICO	PAGINA
2880-FR	Portaimpronta forati in alluminio per implantologia - fresa in carburo di tungsteno		K40
2880-L1	Portaimpronta forati in alluminio per implantologia		K41
2880-L2	Portaimpronta forati in alluminio per implantologia		K41
2880-L3	Portaimpronta forati in alluminio per implantologia		K41
2880-L4	Portaimpronta forati in alluminio per implantologia		K41
2880-L5	Portaimpronta forati in alluminio per implantologia		K41
2880-L6	Portaimpronta forati in alluminio per implantologia		K41
2880-U1	Portaimpronta forati in alluminio per implantologia		K41
2880-U2	Portaimpronta forati in alluminio per implantologia		K41
2880-U3	Portaimpronta forati in alluminio per implantologia		K41
2880-U4	Portaimpronta forati in alluminio per implantologia		K41
2880-U5	Portaimpronta forati in alluminio per implantologia		K41
2880-U6	Portaimpronta forati in alluminio per implantologia		K41
2900E-AT13	Cannule multi-color		A4
2900E-AT15	Cannule multi-color		A4
2900E-ATS15	Cannule multi-color		A5
2900E-BBS15	Cannule multi-color		A5
2900E-BT13	Cannule multi-color		A4
2900E-BT15	Cannule multi-color		A4
2900E-GT13	Cannule multi-color		A4
2900E-GT15	Cannule multi-color		A4
2900E-LT13	Cannule multi-color		A4
2900E-LT15	Cannule multi-color		A4
2900E-OT13	Cannule multi-color		A5
2900E-OT15	Cannule multi-color		A5
2900E-RT13	Cannule multi-color		A5
2900E-RT15	Cannule multi-color		A5
2900E-TCS15	Cannule multi-color		A5
2900E-TT13	Cannule multi-color		A4
2900E-TT15	Cannule multi-color		A4
2900E-TTS15	Cannule multi-color		A5
2900E-VT13	Cannule multi-color		A4
2900E-VT15	Cannule multi-color		A4
2900E-VTS15	Cannule multi-color		A5
2900E-ZT13	Cannule multi-color		A5
2900E-ZT15	Cannule multi-color		A5
2901E-AT13	Cannule multi-color		A4
2901E-AT15	Cannule multi-color		A4
2901E-TT13	Cannule multi-color		A4
2901E-TT15	Cannule multi-color		A4
2901E-VT13	Cannule multi-color		A4
2901E-VT15	Cannule multi-color		A4
2902-L	Cannule chirurgiche in acciaio inox		C44
2902-M	Cannule chirurgiche in acciaio inox		C44
2902-S	Cannule chirurgiche in acciaio inox		C44
2903E-BA155	Cannule con cappuccio morbido - Total-Comfort		A3
2903E-BAS155	Cannule con cappuccio morbido - Total-Comfort		A3
2903E-BT155	Cannule con cappuccio morbido - Total-Comfort		A3
2903E-BTS155	Cannule con cappuccio morbido - Total-Comfort		A3
2903E-TA155	Cannule con cappuccio morbido - Total-Comfort		A3
2903E-TAS155	Cannule con cappuccio morbido - Total-Comfort		A3
2903E-TT155	Cannule con cappuccio morbido - Total-Comfort		A3
2903E-TTS155	Cannule con cappuccio morbido - Total-Comfort		A3
2904-6	Cannule chirurgiche in acciaio inox - Frazier		C44
2904-8	Cannule chirurgiche in acciaio inox - Frazier		C44
2904-10	Cannule chirurgiche in acciaio inox - Frazier		C44
2904-12	Cannule chirurgiche in acciaio inox - Frazier		C44
2908E-AT13	Cannule al profumo di menta - AsaFresh		A2
2908E-AT15	Cannule al profumo di menta - AsaFresh		A2, A6
2908E-BBS15	Cannule al profumo di menta - AsaFresh		A2
2908E-TCS15	Cannule al profumo di menta - AsaFresh		A2
2908E-TT13	Cannule al profumo di menta - AsaFresh		A2
2908E-TT15	Cannule al profumo di menta - AsaFresh		A2
2908E-TTS15	Cannule al profumo di menta - AsaFresh		A2
2908E-VT13	Cannule al profumo di menta - AsaFresh		A2

CODICE	DESCRIZIONE	MANICO	PAGINA
2908E-VT15	Cannule al profumo di menta - AsaFresh		A2
2908E-VTS15	Cannule al profumo di menta - AsaFresh		A2
3030	Pinze per uncini - Ivory lightweight		F12
3031	Pinze per uncini - Brewer		F12
3032	Pinze per forare la diga - Ainsworth		F11
3033	Pinze per forare la diga - Ivory		F11
3034	Pinze per uncini - Stoke		F12
3040-1	Strumenti per diga		F12
3041-1	Strumenti per diga		F12
3045	Strumenti per diga - diga in lattice confezionata in sottovuoto conf. 36 pz		F11
3050-60	Uncini per diga - senza alette		F8
3051-26	Uncini per diga - senza alette		F9
3051-29	Uncini per diga - con alette		F8
3051-51	Uncini per diga - senza alette		F9
3051-202	Uncini per diga - con alette		F10
3051-205	Uncini per diga - senza alette		F10
3051-210	Uncini per diga - con alette		F6
3051-212	Uncini per diga - con alette		F6
3052-0	Uncini per diga - con alette		F7
3052-00	Uncini per diga - con alette		F6
3052-W0	Uncini per diga - senza alette		F7
3052-1	Uncini per diga - con alette		F7
3052-W1	Uncini per diga - senza alette		F7
3052-2	Uncini per diga - con alette		F8
3052-2A	Uncini per diga - con alette		F7
3052-2AT	Uncini per diga - dentellato con alette		F7
3052-2T	Uncini per diga - dentellato con alette		F8
3052-W2	Uncini per diga - senza alette		F8
3052-W2A	Uncini per diga - senza alette		F7
3052-3	Uncini per diga - con alette		F8
3052-W3	Uncini per diga - senza alette		F8
3052-4	Uncini per diga - con alette		F10
3052-W4	Uncini per diga - senza alette		F10
3052-7	Uncini per diga - con alette		F9
3052-W7	Uncini per diga - senza alette		F9
3052-8	Uncini per diga - con alette		F10
3052-8A	Uncini per diga - con alette		F9
3052-W8	Uncini per diga - senza alette		F10
3052-W8A	Uncini per diga - senza alette		F9
3052-9	Uncini per diga - con alette		F6
3052-9T	Uncini per diga - con alette		F6
3052-12A	Uncini per diga - dentellato con alette		F10
3052-13A	Uncini per diga - dentellato con alette		F10
3052-14	Uncini per diga - con alette		F9
3052-14A	Uncini per diga - con alette		F10
3052-14T	Uncini per diga - dentellato con alette		F9
3052-W14	Uncini per diga - senza alette		F9
3052-W14A	Uncini per diga - senza alette		F10
3052-1T	Uncini per diga - dentellato con alette		F7
3070-5	Porta matrici - Ivory		F48
3070-6	Porta matrici - Ivory		F48
3070-7	Porta matrici - Ivory		F48
3071	Porta matrici - Ivory		F48
3072	Porta matrici - Didner		F48
3073-1	Porta matrici - Tofflemire universal		F48
3073-2	Porta matrici - Tofflemire Junior		F48
3073-3	Porta matrici - Tofflemire Senior		F48
3081-1	Matrici - Tofflemire		F49
3081-2	Matrici - Tofflemire		F49
3081-3	Matrici - Tofflemire		F49
3081	Matrici - Tofflemire		F49
3082-5	Bande per porta matrici		F49
3082-6	Bande per porta matrici		F49
3082-7	Bande per porta matrici		F49
3101-1	Accessori - stoppino		J21

CODICE	DESCRIZIONE	MANICO	PAGINA
3101	Accessori - lampada ad alcool		J21
3201	Salviette - AsaRainbow - catenella reggi salviette		A7
3251E-C/6	Mantelline - Rotoli a strappo 50x60 cm (80 bavaglino)		A15
3251E-D/6	Mantelline - Rotoli a strappo 50x60 cm (80 bavaglino)		A15
3251E-O/6	Mantelline - Rotoli a strappo 50x60 cm (80 bavaglino)		A15
3251E-V/6	Mantelline - Rotoli a strappo 50x60 cm (80 bavaglino)		A15
3252E-C/6	Mantelline - Rotoli a strappo 50x80 cm (60 bavaglino)		A15
3252E-D/6	Mantelline - Rotoli a strappo 50x80 cm (60 bavaglino)		A15
3252E-O/6	Mantelline - Rotoli a strappo 50x80 cm (60 bavaglino)		A15
3252E-V/6	Mantelline - Rotoli a strappo 50x80 cm (60 bavaglino)		A15
3400E-55	Rotoli per sterilizzare		A12
3400E-75	Rotoli per sterilizzare		A12
3400E-100	Rotoli per sterilizzare		A12
3400E-150	Rotoli per sterilizzare		A12
3400E-200	Rotoli per sterilizzare		A12
3400E-250	Rotoli per sterilizzare		A12
3400-300	Rotoli per sterilizzare		A12
3403-75	Buste per sterilizzare		A14
3403-90	Buste per sterilizzare		A14
3403-140	Buste per sterilizzare		A14
3450E-B	Mascherine chirurgiche		A13
3450E-C	Mascherine chirurgiche		A13
3450E-N	Mascherine chirurgiche		A13
3450E-R	Mascherine chirurgiche		A13
3450E-V	Mascherine chirurgiche		A13
3510-B	Salviette - AsaRainbow		A6
3510-BX	Salviette - AsaRainbow		A6
3510-C	Salviette - AsaRainbow		A6
3510-D	Salviette - AsaRainbow		A6
3510-F	Salviette - AsaRainbow		A6
3510-G	Salviette - AsaRainbow		A6
3510-GR	Salviette - AsaRainbow		A6
3510-L	Salviette - AsaRainbow		A6
3510-LI	Salviette - AsaRainbow		A7
3510-N	Salviette - AsaRainbow		A7
3510-O	Salviette - AsaRainbow		A7
3510-P	Salviette - AsaRainbow		A7
3510-PE	Salviette - AsaRainbow		A7
3510-V	Salviette - AsaRainbow		A7
3511-B	Salviette - AsaRainbow		A6
3511-BX	Salviette - AsaRainbow		A6
3511-C	Salviette - AsaRainbow		A6
3511-D	Salviette - AsaRainbow		A6
3511-F	Salviette - AsaRainbow		A6
3511-G	Salviette - AsaRainbow		A6
3511-GR	Salviette - AsaRainbow		A6
3511-L	Salviette - AsaRainbow		A6
3511-LI	Salviette - AsaRainbow		A7
3511-N	Salviette - AsaRainbow		A7
3511-O	Salviette - AsaRainbow		A7
3511-P	Salviette - AsaRainbow		A7
3511-PE	Salviette - AsaRainbow		A7
3511-V	Salviette - AsaRainbow		A7
3520-1	Rulli salivari di cotone		A11
3520-2	Rulli salivari di cotone		A11
3520-3	Rulli salivari di cotone		A11
3600E	Ghiaccio sintetico		A18
3700-B	Dappen dishes		A9
3700-C	Dappen dishes		A9
3700-G	Dappen dishes		A9
3700-MX	Dappen dishes		A8
3700-N	Dappen dishes		A9
3700-R	Dappen dishes		A9
3710	Siringhe in plastica		A17
3818-B	Bicchieri		A16

CODICE	DESCRIZIONE	MANICO	PAGINA
5000-1	Articolatori - parti di ricambio - piastrina di montaggio		L6
5000-1M	Articolatori - parti di ricambio - piastrina magnetica completa		L7
5000-4N	Articolatori - parti di ricambio - piano incisale (10°)		L8
5000-5	Articolatori - parti di ricambio - pomello metallico di serraggio		L8
5000-7	Articolatori - parti di ricambio - vite per regolazione molla movimenti laterali		L8
5000-8	Articolatori - parti di ricambio - indicatore incisale		L8
5000-12	Articolatori - parti di ricambio - molla per movimenti laterali		L8
5000-13	Articolatori - parti di ricambio - cilindro per movimenti laterali		L8
5000-18	Articolatori - parti di ricambio - viti M5 per fissaggio base incisale		L8
5000-24	Articolatori - parti di ricambio - piedini in gomma		L8
5000-25	Articolatori - parti di ricambio - contromagneti per gesso		L7
5000-26	Articolatori - parti di ricambio - magnete		L7
5000-30	Articolatori - parti di ricambio - camicia porta magnete		L7
5001	Articolatori - occlusore		L6
5002	Articolatori a valori medi		L6
5010-10	Articolatori - parti di ricambio - asta antiribaltamento		L8
5011-4	Articolatori - parti di ricambio - piano incisale (0°)		L8
5011-6	Articolatori - parti di ricambio - vite di serraggio		L8
5011-11	Articolatori - parti di ricambio - cappuccio in gomma		L8
5011-16	Articolatori - parti di ricambio - piano inclinato di contrasto		L8
5011-18	Articolatori - parti di ricambio - rondella di rasamento asse cerniera		L8
5011-19	Articolatori - parti di ricambio - molla interna asse cerniera		L8
5011-23	Articolatori - parti di ricambio - controvite		L8
5020	Easy Bow - set completo		L10
5021	Easy Bow - arco facciale		L10
5022	Easy Bow - porta forchetta		L10
5023-1	Easy Bow - forchetta		L10
5023-2	Easy Bow - forchetta		L10
5023-3	Easy Bow - forchetta		L10
5024	Easy Bow - tavolo di trasferimento		L10
5030	Articolatori a valori medi		L4
5030-2	Articolatori - parti di ricambio - piano di occlusione		L8
5030-3	Articolatori - parti di ricambio - asta incisale		L8
5030-6	Articolatori - parti di ricambio - vite di serraggio per distanziatore		L8
5030-9	Articolatori - parti di ricambio - asta movimento condilare		L8
5030-10	Articolatori - parti di ricambio - asta antiribaltamento		L8
5030-29	Articolatori - parti di ricambio - distanziatore		L7
5032	Articolatori a valori medi		L5
5032-16	Articolatori - parti di ricambio - piano inclinato di contrasto		L8
5032-17	Articolatori - parti di ricambio - asse cerniera		L8
5032-21	Articolatori - parti di ricambio - asta posteriore		L8
5032-22	Articolatori - parti di ricambio - vite micrometrica di registrazione		L8
5032-23	Articolatori - parti di ricambio - contro vite		L8
5033	Articolatori - parti di ricambio - taratore		L8
5050	Articolatori a valori medi		L2
5050-2	Articolatori - parti di ricambio - supporto per piano occlusale e calotta		L8
5050-3	Articolatori - parti di ricambio - asta incisale		L8
5050-4	Articolatori - parti di ricambio - vite zigrinata per piano occlusale e calotta		L8
5050-6	Articolatori - parti di ricambio - vite di serraggio		L8
5050-8	Articolatori - parti di ricambio - indicatore incisale		L8
5050-17	Articolatori - parti di ricambio - asse cerniera		L8
5050-20	Articolatori - parti di ricambio - porta asta posteriore		L8
5050-21	Articolatori - parti di ricambio - asta posteriore		L8
5050-24	Articolatori - parti di ricambio - piedini in gomma		L8
5050PLUS	Articolatori a valori medi		L3
5051	Articolatori - parti di ricambio - piano di occlusione		L8
5052	Articolatori - parti di ricambio - calotta		L8
5053	Articolatori - parti di ricambio - kit asta magnetica		L8
5053-1	Articolatori - parti di ricambio - asta con magnete incollato		L8
5053-2	Articolatori - parti di ricambio - ghiera per asta		L8
5053-3	Articolatori - parti di ricambio - piano per asta magnetica		L8
5054	Articolatori - parti di ricambio - piano occlusale completo (5050-4 + 5051 + 5050-2)		L8
5100-1	Strumenti per modellare amalgama/cera con manico millimetrato - Hylin		L14
5100	Strumenti per modellare amalgama/cera - Hylin		L14
5101	Strumenti per modellare amalgama/cera - Hylin-Le Cron		L14

CODICE	DESCRIZIONE	MANICO	PAGINA
5102	Strumenti per modellare amalgama/cera · Hylin		L14
5103	Strumenti per modellare amalgama/cera · Hylin		L14
5104	Strumenti per modellare amalgama/cera		L14
5105	Strumenti per modellare amalgama/cera · Le Cron		L15
5106	Strumenti per modellare amalgama/cera · Le Cron		L15
5107	Strumenti per modellare amalgama/cera · Le Cron		L15
5108	Strumenti per modellare amalgama/cera · Le Cron		L15
5109	Strumenti per modellare amalgama/cera · Zahle		L15
5110	Strumenti per modellare amalgama/cera · Zahle		L15
5111	Strumenti per modellare amalgama/cera · Zahle		L16
5112-1	Strumenti per modellare amalgama/cera · P.K. Thomas	Asa60	L17
5112-1AL	Strumenti per modellare amalgama/cera · P.K. Thomas	Alu80	L17
5112-2	Strumenti per modellare amalgama/cera · P.K. Thomas	Asa60	L17
5112-2AL	Strumenti per modellare amalgama/cera · P.K. Thomas	Alu80	L17
5112-3	Strumenti per modellare amalgama/cera · Asa Com 1/1B · P.K. Thomas	Asa60	F50, L17
5112-3AL	Strumenti per modellare amalgama/cera · P.K. Thomas	Alu80	L17
5112-4	Strumenti per modellare amalgama/cera · Asa Com 13/13B · P.K. Thomas	Asa60	F52, L17
5112-4AL	Strumenti per modellare amalgama/cera · P.K. Thomas	Alu80	L17
5112-5	Strumenti per modellare amalgama/cera · P.K. Thomas	Asa60	L17
5112-5AL	Strumenti per modellare amalgama/cera · P.K. Thomas	Alu80	L17
5113	Strumenti per modellare amalgama/cera · Gritman		L16
5114	Strumenti per modellare amalgama/cera · Beale		L16
5114-1	Scollaperiostio ed Elevatori · Beale	Ottagonali	E22, H16
5115	Strumenti per modellare amalgama/cera · Roach		L16
5116	Strumenti per modellare amalgama/cera · Vehe		L16
5150	Strumenti per ceramica e resine di rivestimento		L21
5150-1	Strumenti per ceramica e resine di rivestimento	Alu80	L21
5150-2	Strumenti per ceramica e resine di rivestimento	Alu80	L21
5150-3	Strumenti per ceramica e resine di rivestimento	Alu80	L21
5151	Strumenti per ceramica e resine di rivestimento		L21
5151-1	Strumenti per ceramica e resine di rivestimento · Greenstein	Alu80	L21
5151-2	Strumenti per ceramica e resine di rivestimento · Greenstein	Alu80	L21
5151-3	Strumenti per ceramica e resine di rivestimento · Greenstein	Alu80	L21
5153-1	Strumenti per composito · Asa Com 7/7B	Alu80	F51
5155-1	Strumenti per ceramica e resine di rivestimento		L21
5155-2	Strumenti per ceramica e resine di rivestimento		L21
5155-3	Strumenti per ceramica e resine di rivestimento		L21
5156-1	Strumenti per ceramica e resine di rivestimento		L21
5156-2	Strumenti per ceramica e resine di rivestimento		L21
5156-3	Strumenti per ceramica e resine di rivestimento		L21
5160-1	Strumenti per ceramica e resine di rivestimento (punte)		L18
5160-2	Strumenti per ceramica e resine di rivestimento (punte)		L18
5160-3	Strumenti per ceramica e resine di rivestimento (punte)		L18
5200-1	Coltelli per cera · Fahrenstock		L22
5200-2	Coltelli per cera · Fahrenstock		L22
5201-1	Coltelli per cera · Lessmann		L22
5201-2	Coltelli per cera · Lessmann		L22
5202-1	Coltelli per cera		L22
5202-2	Coltelli per cera		L22
5300-1	Coltelli per gessi		L23
5300-2	Coltelli per gessi · Gritman		L23
5300-3	Coltelli per gessi		L23
5300-4	Coltelli per gessi		L23
5400-1	Spatole rigide per alginato, gesso ed elastomeri		L24
5400-2	Spatole rigide per alginato, gesso ed elastomeri		L24
5400-3	Spatole rigide per alginato, gesso ed elastomeri		L24
5400-4	Spatole flessibili per alginato, gesso ed elastomeri		L25
5400-5	Spatole flessibili per alginato, gesso ed elastomeri		L25
5400-6	Spatole flessibili per alginato, gesso ed elastomeri		L25
5400-7	Spatole flessibili per alginato, gesso ed elastomeri		L25
5400-8	Spatole rigide per alginato, gesso ed elastomeri		L24
5400-9	Spatole rigide per alginato, gesso ed elastomeri		L24
5401-B	Spatole per alginato e gesso		L26
5401-C	Spatole per alginato e gesso		L26
5401-F	Spatole per alginato e gesso		L26

CODICE	DESCRIZIONE	MANICO	PAGINA
5401-G	Spatole per alginato e gesso		L26
5401-R	Spatole per alginato e gesso		L26
5401-V	Spatole per alginato e gesso		L26
5500-10	Tazze per alginato e gesso		L26
5500-12	Tazze per alginato e gesso		L26
5500-14	Tazze per alginato e gesso		L26
5500-16	Tazze per alginato e gesso		L26
5501-10	Tazze per alginato e gesso		L26
5501-12	Tazze per alginato e gesso		L26
5501-14	Tazze per alginato e gesso		L26
5501-16	Tazze per alginato e gesso		L26
5600-1	Forbici per corone · rette, una punta dentata		F47, L28
5600-2	Forbici per corone · curve, una punta dentata		F47, L28
5601-1	Forbici per corone · rette		F47, L28
5601-2	Forbici per corone · curve		F47, L28
5700	Forbici universali · rette, una punta dentata · universal		F47, L28
5700TC	Forbici universali · TC universal		F47
5800	Pinze per piegare fili · Nance		I12
5801-1	Pinze per piegare fili · universali · Delphin		I10
5801-3	Pinze per piegare fili · universali		I10
5802	Pinze per piegare fili · Waldsachs		I11
5806	Pinze per piegare fili		I12
5809-1	Pinze per piegare fili · Tweed		I12
5809-2	Pinze per piegare fili · Tweed		I13
5809-3	Pinze per piegare fili · Tweed		I15
5812	Pinze per piegare fili · Reynolds		I16
5818	Pinze per piegare fili		I16
5819	Pinze di utilità · Weingart		I29
5821-1	Pinze per piegare fili · De La Rosa		I18
5821-2	Pinze per piegare fili · De La Rosa		I18
5824-1	Pinze di utilità		I31
5825	Pinze di utilità		I32
5826-1	Pinze di utilità		I30
5826-2	Pinze di utilità		I30
5828-1	Pinze di utilità		I30
5828-2	Pinze di utilità		I31
5832-1TC	Tronchesi · tronchese per fili multiuso		I7
5832	Tronchesi · tronchese per fili multiuso		I7
5833-1TC	Tronchesi · tronchese in miniatura per recidere fili		I8
5833	Tronchesi · tronchese in miniatura per recidere fili		I8
5836-1TC	Tronchesi · tronchese per taglio distale		I9
5836	Tronchesi · tronchese per taglio distale		I9
5837	Tronchesi · tronchese per taglio distale micro		I9
5838	Pinze per piegare fili · con lama · Angle		I19
5860-1	Pinze per piegare fili · Mc Kellops		I18
5861	Pinze per piegare fili · Johnson		I20
5862	Pinze per piegare fili · Nance		I15
5863	Pinze per piegare fili · Young		I14
5864	Pinze per piegare fili		I18
5865	Pinze per piegare fili		I19
5866	Pinze per piegare fili · Angle		I19
5867-1	Pinze per piegare fili · Adams		I20
5867-2	Pinze per piegare fili · Adams		I20
5868	Pinze per piegare fili		I19
5869-1	Pinze per piegare fili · mini · Aderer		I21
5869-2	Pinze per piegare fili · standard · Aderer		I21
5870	Pinze per piegare fili · Tweed		I14
5871	Pinze per piegare fili		I24
5872-1	Pinze per piegare fili · Tweed (Angle)		I15
5874-1	Pinze per piegare fili · universali · How		I23
5874-2	Pinze per piegare fili · How		I23
5875-1	Pinze per piegare fili		I24
5875-2	Pinze per piegare fili		I24
5876-1	Pinze per piegare fili		I24
5876-2	Pinze per piegare fili		I24

CODICE	DESCRIZIONE	MANICO	PAGINA
5880-1	Tronchesi · tagli filo <= 0.9 mm		I8
5880-2	Tronchesi · tagli filo <= 1.5 mm		I8
5880-3TC	Tronchesi · tagli filo <= 1.2 mm		I9
5900	Cesoia taglia gesso · Asa Special Inox		L31
6000	Martelli		L31
6001	Martelli		L31
6002	Martelli		L31
6200	Seghetto		L33
6201-1	Lame per seghetto · per gesso		L33
6201-2	Lame per seghetto · per metallo		L33
6300	Sega per modelli		L33
6301-1	Lame per seghetto · per modelli		L33
6301-2	Lame per seghetto · per modelli		L33
6301-3	Lame per seghetto · per modelli		L33
6400-1	Pinzette per laboratorio		L19
6400-2	Pinzette per laboratorio		L19
6600-2	Pinze per cilindri e muffole		L32
6600-4	Pinze per cilindri e muffole		L32
6600-5	Pinze per cilindri e muffole		L32
6900E-A	Contenitori per protesi/ortodontici · Blu		I37, L27
6900E-B	Contenitori per protesi/ortodontici · Bianco		I37, L27
6900E-C	Contenitori per protesi/ortodontici · Celeste		I37, L27
6900E-G	Contenitori per protesi/ortodontici		I37, L27
6900E-R	Contenitori per protesi/ortodontici		I37, L27
6900E-V	Contenitori per protesi/ortodontici		I37, L27
7000-6	Pennelli per ceramica		L20
7000-8	Pennelli per ceramica		L20
7001-0	Pennelli per ceramica		L20
7001-00	Pennelli per ceramica		L20
7001-1	Pennelli per ceramica		L20
7001-3	Pennelli per ceramica		L20
7002-4	Pennelli per ceramica		L20
7002-6	Pennelli per ceramica		L20
7002-8	Pennelli per ceramica		L20
8000	"Lab Set" per Odontotecnica		L34
8001	Pietre per affilare · Asa Oil		H33
8002	Lubrificanti protettivi per strumenti · Steril Oil		D73, J14
8010	Lubrificanti protettivi per strumenti · Silicone		D73, J14
8020	AsaClean · soluzione PH neutra per facilitare la rimozione di alginato		K44
8801-1	Pinze per piegare fili · universali · Delphin		I10
8801-2	Pinze per piegare fili · universali		I10
8802	Pinze per piegare fili · Waldsachs		I11
8803	Pinze per piegare fili		I26
8804-1	Pinze per piegare fili · Tweed		I14, I28
8804-2	Pinze per piegare fili · Tweed		I13, I28
8804-2P	Pinze per piegare fili		I13
8804-3P	Pinze per piegare fili		I13
8805	Pinze per piegare fili · Reynolds		I16
8806	Pinze per piegare fili		I26
8807-1	Pinze per piegare fili		I17, I28
8807-2	Pinze per piegare fili		I17, I28
8807-3	Pinze per piegare fili		I16, I28
8808-1	Pinze di utilità · Weingart		I29
8808-2	Pinze di utilità · Weingart		I29
8809	Pinze di utilità		I31
8810	Pinze di utilità		I32
8811-1	Pinze di utilità		I30
8811-1P	Pinze di utilità		I30, I31
8811-2	Pinze di utilità		I31
8812-1TC	Tronchesi		I7
8812-2TC	Tronchesi		I4
8813-1TC	Tronchesi		I4
8814-1TC	Tronchesi		I5
8815	Pinze per piegare fili · Johnson		I20
8816	Pinze per piegare fili · Nance		I11, I28

CODICE	DESCRIZIONE	MANICO	PAGINA
8817	Pinze per piegare fili · Young		I14
8818	Pinze per piegare fili		I22, I28
8819	Pinze per piegare fili · Adams		I20, I28
8820-1	Pinze per piegare fili · Aderer		I21, I28
8820-2	Pinze per piegare fili · Aderer		I21, I28
8821	Pinze per piegare fili		I22, I28
8822-1	Pinze per piegare fili · universali · How		I23
8822-2	Pinze per piegare fili · How		I23
8823	Pinze per piegare fili · Schwarz		I25, I28
8824-1TC	Tronchesi		I6
8825	Pinze per piegare fili		I25, I28
8826-1TC	Tronchesi		I5
8827-1TC	Tronchesi		I6
8828-1TC	Pinze di utilità		I33
8829	Pinze per piegare fili · Jarabak		I27
8830	Pinze per piegare fili		I27, I28
8831	Pinze di utilità		I32
8831-1P	Pinze di utilità		I32
8832	Posizionatore di Bracket		I36
9002-1	Inseri per 6 pinze estrattive		D73
9002-2	Inseri con elastici per 10 strumenti		D73
9002-3	Inseri con spazi per 16 strumenti		D73
9002	Valigia portastrumenti e pinze		D73
AL2720-LA	Vassoi portastrumenti in alluminio anodizzato colorato · Argento		J8
AL2720-LC	Vassoi portastrumenti in alluminio anodizzato colorato · Celeste		J8
AL2720-LO	Vassoi portastrumenti in alluminio anodizzato colorato · Oro		J8
AL2720-LR	Vassoi portastrumenti in alluminio anodizzato colorato · Rosso		J8
AL2720-LV	Vassoi portastrumenti in alluminio anodizzato colorato · Verde		J8
AL2720-UA	Vassoi portastrumenti in alluminio anodizzato colorato · Argento		J8
AL2721-LA	Vassoi portastrumenti in alluminio anodizzato colorato · forati · Argento		J9
AL2721-LC	Vassoi portastrumenti in alluminio anodizzato colorato · forati · Celeste		J9
AL2721-LO	Vassoi portastrumenti in alluminio anodizzato colorato · forati · Oro		J9
AL2721-LR	Vassoi portastrumenti in alluminio anodizzato colorato · forati · Rosso		J9
AL2721-LV	Vassoi portastrumenti in alluminio anodizzato colorato · forati · Verde		J9
AL2721-UA	Vassoi portastrumenti in alluminio anodizzato colorato · forati · Argento		J9
AL2722-LA	Vassoi portastrumenti in alluminio anodizzato colorato · Argento		J10
AL2722-LC	Vassoi portastrumenti in alluminio anodizzato colorato · Celeste		J10
AL2722-LO	Vassoi portastrumenti in alluminio anodizzato colorato · Oro		J10
AL2722-LR	Vassoi portastrumenti in alluminio anodizzato colorato · Rosso		J10
AL2722-LV	Vassoi portastrumenti in alluminio anodizzato colorato · Verde		J10
AL2722-UA	Vassoi portastrumenti in alluminio anodizzato colorato · Argento		J10
AL2723-LA	Vassoi portastrumenti in alluminio anodizzato colorato · Argento		J11
AL2723-LC	Vassoi portastrumenti in alluminio anodizzato colorato · Celeste		J11
AL2723-LO	Vassoi portastrumenti in alluminio anodizzato colorato · Oro		J11
AL2723-LR	Vassoi portastrumenti in alluminio anodizzato colorato · Rosso		J11
AL2723-LV	Vassoi portastrumenti in alluminio anodizzato colorato · Verde		J11
AL2723-UA	Vassoi portastrumenti in alluminio anodizzato colorato · Argento		J11
AL2724-1	Contenitori in alluminio anodizzato per vassoi portastrumenti		J15
AL2724-2	Contenitori in alluminio anodizzato per vassoi portastrumenti		J15
AL2724-3	Contenitori in alluminio anodizzato per vassoi portastrumenti		J15
AL2724-4	Contenitori in alluminio anodizzato per vassoi portastrumenti		J15
AL2725	Accessori per endodonzia		J18
AL2727-1	Vassoi in plastica		A10
AL2727-1Z	Vassoi in plastica		A10
AL2727-2	Vassoi in plastica		A10
AL2727-2Z	Vassoi in plastica		A10
AL2730-1	Griglie portastrumenti in alluminio · per 11 strumenti		J12
AL2730-2	Griglie portastrumenti in alluminio · per 17 strumenti		J12
AL2730-3	Griglie portastrumenti in alluminio · per 10 strumenti		J12
AL2730-4	Griglie portastrumenti in alluminio · per 11 strumenti		J12
AL2731-1	Griglie portastrumenti in alluminio · per 8 strumenti		J12
AL2731-2	Griglie portastrumenti in alluminio · per 4 strumenti		J12
AL2735	Pozzetti		A17
AL2736	Spatole per miscelazione		A17
AL2738-1	Vassoi in plastica		A10

CODICE	DESCRIZIONE	MANICO	PAGINA
AL2738-2	Vassoi in plastica		A10
AL2739-1	Porta vassoi in alluminio · 6 ripiani		J15
AL2739-2	Porta vassoi in alluminio · 6 ripiani		J15
AL2740-1	Contenitori per endodonzia		J16
AL2740-2	Contenitori per endodonzia		J16
AL2740-3	Contenitori per endodonzia		J16
AL2740-4	Contenitori per endodonzia		J16
AL2740-5	Contenitori per endodonzia		J16
AL2740-R	Contenitori per endodonzia		J16, J17
AL2741-1	Contenitori per endodonzia		J16
AL2741-2	Contenitori per endodonzia		J16
AL2742-1	Contenitori per endodonzia		J17
AL2742-2	Contenitori per endodonzia		J17
AL2742-3	Contenitori per endodonzia		J17
AL2742-4	Contenitori per endodonzia		J17
AL2742-5	Contenitori per endodonzia		J17
AL2742-6	Contenitori per endodonzia		J17
AL2742-7	Contenitori per endodonzia		J17
AL2743	Contenitori per endodonzia		J17
AL2744	Contenitori per endodonzia		J17
AL2745-1A	Accessori per endodonzia		J18
AL2745-2C	Accessori per endodonzia		J18
AL2746-1	Accessori per endodonzia		J18
AL2746-2	Accessori per endodonzia		J18
AL2747-1A	Accessori per endodonzia		J18
AL2760-1	Porta frese · con bordo, 24 fori FG		J19
AL2760-2	Porta frese · alluminio, sterilizzabile in autoclave a vapore saturo - con bordo, 24 fori CA		E34, J19
AL2760-3	Porta frese · alluminio, sterilizzabile in autoclave a vapore saturo - con bordo, 24 fori FG/CA		E34, J19
AL2760-U	Porta frese · coperchio		J19
AL2761-1	Porta frese · con bordo, 36 fori FG		J19
AL2761-2	Porta frese · con bordo, 36 fori CA		J19
AL2761-3	Porta frese · con bordo, 36 fori FG/CA		J19
AL2761-U	Porta frese · coperchio		E34, J19
AL2762-1	Porta frese · alluminio, sterilizzabile in autoclave a vapore saturo - 48 fori FG		J19
AL2762-2	Porta frese · alluminio, sterilizzabile in autoclave a vapore saturo - 48 fori CA		E34, J19
AL2762-3	Porta frese · alluminio, sterilizzabile in autoclave a vapore saturo - 48 fori FG/CA		J19
AL2763-1	Porta frese · con 7 porta frese, con coperchio		J19
AL2763-2	Porta frese · con 2 porta frese		J19
AL2764-A	Accessori · porta rifiuti in alluminio anodizzato		J20
AL2764-C	Accessori · porta rifiuti in alluminio anodizzato		J20
AL2764-O	Accessori · porta rifiuti in alluminio anodizzato		J20
AL2764-R	Accessori · porta rifiuti in alluminio anodizzato		J20
AL2764-V	Accessori · porta rifiuti in alluminio anodizzato		J20
AL2765-A	Accessori · distributori di cotone in alluminio anodizzato		J20
AL2765-C	Accessori · distributori di cotone in alluminio anodizzato		J20
AL2765-O	Accessori · distributori di cotone in alluminio anodizzato		J20
AL2765-R	Accessori · distributori di cotone in alluminio anodizzato		J20
AL2765-V	Accessori · distributori di cotone in alluminio anodizzato		J20
AL2766	Accessori · contenitori in plastica per aghi usati		A17, J21
AL2767-1	Accessori · porta rifiuti		A18, J20
AL2767-2	Accessori · supporto in alluminio per porta rifiuti		A18, J20
LV1807-02	Curette Gracey	Leonardo Light	H11
LV1807-02AF	Curette Gracey - AF	Leonardo Light	H12
LV1807-02MF	Curette Gracey - MF	Leonardo Light	H13
LV1807-04	Curette Gracey	Leonardo Light	H11
LV1807-04AF	Curette Gracey - AF	Leonardo Light	H12
LV1807-04MF	Curette Gracey - MF	Leonardo Light	H13
LV1807-06	Curette Gracey	Leonardo Light	H11
LV1807-06AF	Curette Gracey - AF	Leonardo Light	H12
LV1807-06MF	Curette Gracey - MF	Leonardo Light	H13
LV1807-08	Curette Gracey	Leonardo Light	H11
LV1807-08AF	Curette Gracey - AF	Leonardo Light	H12
LV1807-08MF	Curette Gracey - MF	Leonardo Light	H13
LV1807-10	Curette Gracey	Leonardo Light	H11
LV1807-11MD	Curette Gracey	Leonardo Light	H11

CODICE	DESCRIZIONE	MANICO	PAGINA
LV1807-12	Curette Gracey	Leonardo Light	H11
LV1807-12AF	Curette Gracey - AF	Leonardo Light	H12
LV1807-12MF	Curette Gracey - MF	Leonardo Light	H13
LV1807-13MD	Curette Gracey	Leonardo Light	H11
LV1807-14	Curette Gracey	Leonardo Light	H11
LV1807-14AF	Curette Gracey - AF	Leonardo Light	H12
LV1807-14MF	Curette Gracey - MF	Leonardo Light	H13
LV1807-16	Curette Gracey	Leonardo Light	H11
LV1807-16AF	Curette Gracey - AF	Leonardo Light	H12
LV1807-16MF	Curette Gracey - MF	Leonardo Light	H13
LV1807-18	Curette Gracey	Leonardo Light	H11
LV1807-02SF	Curette Gracey · Sharpen Free	Leonardo Light	H11
LV1807-04SF	Curette Gracey · Sharpen Free	Leonardo Light	H11
LV1807-06SF	Curette Gracey · Sharpen Free	Leonardo Light	H11
LV1807-08SF	Curette Gracey · Sharpen Free	Leonardo Light	H11
LV1807-10SF	Curette Gracey · Sharpen Free	Leonardo Light	H11
LV1807-12SF	Curette Gracey · Sharpen Free	Leonardo Light	H11
LV1807-14SF	Curette Gracey · Sharpen Free	Leonardo Light	H11
LV1807-16SF	Curette Gracey · Sharpen Free	Leonardo Light	H11
LV1807-18SF	Curette Gracey · Sharpen Free	Leonardo Light	H11
LV1826-T03	Curette e Scaler · Taylor	Leonardo Light	H8
LV1827-204S	Curette e Scaler	Leonardo Light	H8
LV1829-CK6	Curette e Scaler · Crane-Kaplan	Leonardo Light	H8
MB026-1	Compasso in acciaio inox		K20
ML0700-3R	Sonde singole · Rhein	Leonardo ML	B6
ML0700-6	Sonde singole	Leonardo ML	B6
ML0700-8	Sonde singole	Leonardo ML	B6
ML0700-9	Sonde singole	Leonardo ML	B6
ML0700-17	Sonde singole	Leonardo ML	B6
ML0700-23	Sonde singole	Leonardo ML	B6
ML0702-OMS	Sonde millimetriche parodontali · Novatech	Leonardo ML	H3
ML0703-14	Sonde millimetriche parodontali · Williams	Leonardo ML	H3
ML0704-6D2	Sonde doppie	Leonardo ML	B9
ML0704-6D9	Sonde doppie	Leonardo ML	B8
ML0704-11/12AF	Sonde doppie	Leonardo ML	B8
ML0704-23D1	Sonde doppie	Leonardo ML	B8
ML0705-23W	Combinazioni Sonde · Sonde millimetriche · Williams	Leonardo ML	B10
ML0708-2N	Sonde doppie · Nabers	Leonardo ML	B11
ML0800-1	Strumenti per trattamenti canalari	Leonardo ML	B12, G4
ML0800-2	Strumenti per trattamenti canalari	Leonardo ML	B12, G4
ML0800-3	Strumenti per trattamenti canalari	Leonardo ML	B12, G4
ML0802-1	Otturatori per canali · Schilder	Leonardo ML	B14, G6
ML0802-2	Otturatori per canali · Schilder	Leonardo ML	B14, G6
ML0802-3	Otturatori per canali · Schilder	Leonardo ML	B14, G6
ML0802-4	Otturatori per canali · Schilder	Leonardo ML	B14, G6
ML0802-5	Otturatori per canali · Schilder	Leonardo ML	B14, G6
ML0802-6	Otturatori per canali · Schilder	Leonardo ML	B14, G6
ML0802-7	Otturatori per canali · Schilder	Leonardo ML	B14, G6
ML0802-8	Otturatori per canali · Schilder	Leonardo ML	B14, G6
ML0802-9	Otturatori per canali · Schilder	Leonardo ML	B14, G6
ML0802-10	Otturatori per canali · Schilder	Leonardo ML	B14, G6
ML0803-1	Otturatori per canali · Machtou	Leonardo ML	B13, G5
ML0803-2	Otturatori per canali · Machtou	Leonardo ML	B13, G5
ML0803-3	Otturatori per canali · Machtou	Leonardo ML	B13, G5
ML0803-4	Otturatori per canali · Machtou	Leonardo ML	B13, G5
ML0804-1	Misuratore di profondità		E32
ML0805-1	Apical - Plugger PIR1	Leonardo ML	G10, G14
ML1102-1	Spatole Heidemann	Leonardo ML	F27, G18
ML1222-1	Apical - Plugger PIR2	Leonardo ML	G10, G14
ML1222-2	Apical - Plugger PIR3	Leonardo ML	G10, G14
ML1401-0	Otturatori per amalgama · Foc	Leonardo ML	F33
ML1401-0S	Otturatori per amalgama · Foc	Leonardo ML	F33
ML1401-1	Otturatori per amalgama · Foc	Leonardo ML	F33
ML1401-1S	Otturatori per amalgama · Foc	Leonardo ML	F33
ML1401-2	Otturatori per amalgama · Foc	Leonardo ML	F33

CODICE	DESCRIZIONE	MANICO	PAGINA
ML1401-2S	Otturatori per amalgama · Foc	Leonardo ML	F33
ML1710-5	Escavatori · SS. White	Leonardo ML	F19
ML1710-14	Escavatori · SS. White	Leonardo ML	F19
ML1710-17	Escavatori · SS. White	Leonardo ML	F19
ML1710-18	Escavatori · SS. White	Leonardo ML	F19
ML1710-19	Escavatori · SS. White	Leonardo ML	F19
ML1710-20	Escavatori · SS. White	Leonardo ML	F19
ML1711-1	Escavatori · Darby-Perry	Leonardo ML	F20
ML1711-2	Escavatori · Darby-Perry	Leonardo ML	F20
ML1711-11	Escavatori · Darby-Perry	Leonardo ML	F20
ML1711-12	Escavatori · Darby-Perry	Leonardo ML	F20
ML1711-21	Escavatori · Darby-Perry	Leonardo ML	F20
ML1711-22	Escavatori · Darby-Perry	Leonardo ML	F20
ML1711-31	Escavatori · Darby-Perry	Leonardo ML	F20
ML1711-32	Escavatori · Darby-Perry	Leonardo ML	F20
ML1711-41	Escavatori · Darby-Perry	Leonardo ML	F20
ML1711-42	Escavatori · Darby-Perry	Leonardo ML	F20
ML1711-243	Escavatori · ASH	Leonardo ML	F18
ML1711-G2	Escavatori · ASH	Leonardo ML	F18
ML1803-D	Bisturi per gengivectomia · Kirkland	Leonardo ML	H24
ML1804-D	Bisturi per gengivectomia · Orban	Leonardo ML	H24
ML1806-2RL	Curette e Scaler · Columbia	Leonardo ML	H4
ML1806-4RL	Curette e Scaler · Columbia	Leonardo ML	H4
ML1806-14	Curette e Scaler · Columbia	Leonardo ML	H4
ML1807-02	Curette Gracey	Leonardo ML	G17, H11
ML1807-02AF	Curette Gracey - AF	Leonardo ML	H12
ML1807-02MF	Curette Gracey - MF	Leonardo ML	H13
ML1807-04	Curette Gracey	Leonardo ML	H11
ML1807-04AF	Curette Gracey - AF	Leonardo ML	H12
ML1807-04MF	Curette Gracey - MF	Leonardo ML	H13
ML1807-06	Curette Gracey	Leonardo ML	H11
ML1807-06AF	Curette Gracey - AF	Leonardo ML	H12
ML1807-06MF	Curette Gracey - MF	Leonardo ML	H13
ML1807-08	Curette Gracey	Leonardo ML	H11
ML1807-08AF	Curette Gracey - AF	Leonardo ML	H12
ML1807-08MF	Curette Gracey - MF	Leonardo ML	H13
ML1807-10	Curette Gracey	Leonardo ML	H11
ML1807-11MD	Curette Gracey	Leonardo ML	H11
ML1807-12	Curette Gracey	Leonardo ML	H11
ML1807-12AF	Curette Gracey - AF	Leonardo ML	H12
ML1807-12MF	Curette Gracey - MF	Leonardo ML	H13
ML1807-13MD	Curette Gracey	Leonardo ML	H11
ML1807-14	Curette Gracey	Leonardo ML	G17, H11
ML1807-14AF	Curette Gracey - AF	Leonardo ML	H12
ML1807-14MF	Curette Gracey - MF	Leonardo ML	H13
ML1807-16	Curette Gracey	Leonardo ML	H11
ML1807-16AF	Curette Gracey - AF	Leonardo ML	H12
ML1807-16MF	Curette Gracey - MF	Leonardo ML	H13
ML1807-18	Curette Gracey	Leonardo ML	H11
ML1809-1	Curette e Scaler · Goldman-Fox	Leonardo ML	H6
ML1809-2	Curette e Scaler · Goldman-Fox	Leonardo ML	H6
ML1809-3	Curette e Scaler · Goldman-Fox	Leonardo ML	H6
ML1809-4	Curette e Scaler · Goldman-Fox	Leonardo ML	H6
ML1809-5	Curette e Scaler · Goldman-Fox	Leonardo ML	H6
ML1809-21	Curette e Scaler · Goldman-Fox	Leonardo ML	H6
ML1816-06	Bisturi per gengivectomia · Buck	Leonardo ML	H24
ML1825-14S	Curette e Scaler · Mc Call	Leonardo ML	H7
ML1826-T03	Curette e Scaler · Taylor	Leonardo ML	H8
ML1827-204S	Curette e Scaler	Leonardo ML	H8
ML1829-CK6	Curette e Scaler · Crane-Kaplan	Leonardo ML	H8
ML1829-CK6S	Curette e Scaler · Mini Crane-Kaplan	Leonardo ML	H8
ML1830-YG08	Curette e Scaler · Younger-Good	Leonardo ML	H8
ML1845-1	Periotomi	Leonardo ML	D70, E29
ML1845-2	Periotomi	Leonardo ML	D70, E29
ML1845-3	Periotomi	Leonardo ML	D70, E29

CODICE	DESCRIZIONE	MANICO	PAGINA
ML1900-M23	Scaler · Universal Scaler	Leonardo ML	H14
ML1902-1	Scaler · Towner Jacquette	Leonardo ML	H14
ML1903	Scaler · Towner	Leonardo ML	H14
ML1906-1	Scaler · Jacquette	Leonardo ML	H15
ML1906-2	Scaler · Jacquette	Leonardo ML	H15
ML1906-3	Scaler · Jacquette	Leonardo ML	H15
ML2000-1	Cucchiai alveolari · Hemingway	Leonardo ML	C45, E21, H20
ML2000-2	Cucchiai alveolari · Hemingway	Leonardo ML	C45, E21, H20
ML2000-3	Cucchiai alveolari · Hemingway	Leonardo ML	C45, E21, H20
ML2000-4	Cucchiai alveolari · Hemingway	Leonardo ML	H20
ML2001-85	Cucchiai alveolari · Lucas	Leonardo ML	H20
ML2001-86	Cucchiai alveolari · Lucas	Leonardo ML	H20
ML2001-87	Cucchiai alveolari · Lucas	Leonardo ML	H20
ML2001-88	Cucchiai alveolari · Lucas	Leonardo ML	H20
ML2017-1	Apical - Bone curette FAR1	Leonardo ML	G11, G15
ML2017-2	Apical - Bone curette FAR2	Leonardo ML	G11, G15
ML2101	Manici per specchietti	Leonardo ML	B19, G11, G15, G16
MV0704-16D1	Sonde doppie	Asa Light MV	B8
MV0704-16D2	Sonde doppie	Asa Light MV	B8
MV0704-23D1	Sonde doppie	Asa Light MV	B8
MV0704-23D2	Sonde doppie	Asa Light MV	B8
MV0704-UT1	Sonde doppie · Cattoni	Asa Light MV	B8
MV0705-3GF	Sonde per canali · Goldman-Fox	Asa Light MV	B10
MV0705-16GF	Combinazioni Sonde - Sonde millimetriche · Goldman-Fox	Asa Light MV	B10
MV0705-16W	Combinazioni Sonde - Sonde millimetriche · Williams	Asa Light MV	B10
MV0705-17GF	Combinazioni Sonde - Sonde millimetriche · Goldman-Fox	Asa Light MV	B10
MV0705-17UM	Combinazioni Sonde - Sonde millimetriche · University of Michigan	Asa Light MV	B10
MV0705-17W	Combinazioni Sonde - Sonde millimetriche · Williams	Asa Light MV	B10
MV0705-23GF	Combinazioni Sonde - Sonde millimetriche · Goldman-Fox	Asa Light MV	B10
MV0705-23UM	Combinazioni Sonde - Sonde millimetriche · University of Michigan	Asa Light MV	B10
MV0705-23W	Combinazioni Sonde - Sonde millimetriche · Williams	Asa Light MV	B10
MV0706-2311	Combinazioni Sonde - Sonde millimetriche	Asa Light MV	B10
MV0706-2312	Combinazioni Sonde - Sonde millimetriche	Asa Light MV	B10
MV0707-GFW	Combinazioni Sonde - Sonde millimetriche · Goldman-Fox Williams	Asa Light MV	B11
MV0708-1N	Sonde doppie · Nabers	Asa Light MV	B11
MV0708-2N	Sonde doppie · Nabers	Asa Light MV	B11
MV0709-2	Sonde doppie	Asa Light MV	B8
MV0709-2A	Sonde doppie	Asa Light MV	B8
MV0709-3	Sonde doppie	Asa Light MV	B9
MV0710-6D1	Sonde per canali	Asa Light MV	B9
MV0710-6D2	Sonde per canali	Asa Light MV	B9
MV0710-6D3	Sonde per canali	Asa Light MV	B9
MV1102-1	Spatole Heidemann	Asa Light MV	F27
MV1102-2	Spatole Heidemann	Asa Light MV	F27
MV1102-3	Spatole Heidemann	Asa Light MV	F27
MV1200-1	Otturatori per amalgama	Asa Light MV	F29
MV1200-2	Otturatori per amalgama	Asa Light MV	F29
MV1200-3	Otturatori per amalgama	Asa Light MV	F29
MV1200-4	Otturatori per amalgama	Asa Light MV	F29
MV1200-5	Otturatori per amalgama	Asa Light MV	F29
MV1201-1	Otturatori per amalgama	Asa Light MV	F29
MV1201-1L	Otturatori per amalgama	Asa Light MV	F29
MV1201-2	Otturatori per amalgama	Asa Light MV	F29
MV1201-2L	Otturatori per amalgama	Asa Light MV	F29
MV1201-3	Otturatori per amalgama	Asa Light MV	F29
MV1201-3L	Otturatori per amalgama	Asa Light MV	F29
MV1202-1	Otturatori per amalgama	Asa Light MV	F30
MV1202-1L	Otturatori per amalgama	Asa Light MV	F30
MV1202-2	Otturatori per amalgama	Asa Light MV	F30
MV1202-2L	Otturatori per amalgama	Asa Light MV	F30
MV1202-3	Otturatori per amalgama	Asa Light MV	F30
MV1202-3L	Otturatori per amalgama	Asa Light MV	F30
MV1202-4	Otturatori per amalgama	Asa Light MV	F30
MV1202-4L	Otturatori per amalgama	Asa Light MV	F30
MV1203-1	Otturatori per amalgama	Asa Light MV	F30

CODICE	DESCRIZIONE	MANICO	PAGINA
MV1203-2	Otturatori per amalgama	Asa Light MV	F30
MV1203-3	Otturatori per amalgama	Asa Light MV	F30
MV1204-1	Otturatori - Brunitori - Westcott	Asa Light MV	F34
MV1204-2	Otturatori - Brunitori - Westcott	Asa Light MV	F34
MV1205-1	Otturatori per amalgama - Ward	Asa Light MV	F31
MV1205-2	Otturatori per amalgama - Ward	Asa Light MV	F31
MV1206-1	Strumenti per otturazioni plastiche	Asa Light MV	F36
MV1206-2	Strumenti per otturazioni plastiche	Asa Light MV	F36
MV1207-1	Strumenti per otturazioni plastiche	Asa Light MV	F36
MV1207-2	Strumenti per otturazioni plastiche	Asa Light MV	F36
MV1208-1	Strumenti per otturazioni plastiche	Asa Light MV	F36
MV1208-2	Strumenti per otturazioni plastiche	Asa Light MV	F36
MV1208-3	Strumenti per otturazioni plastiche	Asa Light MV	F36
MV1209-1	Strumenti per otturazioni plastiche	Asa Light MV	F36
MV1209-2	Strumenti per otturazioni plastiche	Asa Light MV	F36
MV1209-3	Strumenti per otturazioni plastiche	Asa Light MV	F36
MV1210-1	Strumenti per otturazioni plastiche	Asa Light MV	F37
MV1210-2	Strumenti per otturazioni plastiche	Asa Light MV	F37
MV1210-3	Strumenti per otturazioni plastiche	Asa Light MV	F37
MV1211-0T	Otturatori per amalgama - Tanner	Asa Light MV	F31
MV1211-1T	Otturatori per amalgama - Tanner	Asa Light MV	F31
MV1211-2T	Otturatori per amalgama - Tanner	Asa Light MV	F31
MV1211-3T	Otturatori per amalgama - Tanner	Asa Light MV	F31
MV1212-01	Otturatori per amalgama - Marquette	Asa Light MV	F31
MV1213-H1	Otturatori per amalgama - Hollenback	Asa Light MV	F31
MV1213-H2	Otturatori per amalgama - Hollenback	Asa Light MV	F31
MV1213-H3	Otturatori per amalgama - Hollenback	Asa Light MV	F31
MV1213-H4	Otturatori per amalgama - Hollenback	Asa Light MV	F31
MV1214-2	Otturatori - Brunitori - Ladmore	Asa Light MV	F34
MV1214-3	Otturatori - Brunitori - Ladmore	Asa Light MV	F34
MV1215-18	Otturatori - Brunitori - Ball	Asa Light MV	F34
MV1215-27S	Otturatori - Brunitori	Asa Light MV	F34
MV1215-29	Otturatori - Brunitori - Ball	Asa Light MV	F34
MV1216-1	Strumenti per otturazioni plastiche - Woodson	Asa Light MV	F37
MV1216-2	Strumenti per otturazioni plastiche - Woodson	Asa Light MV	F37
MV1216-3	Strumenti per otturazioni plastiche - Woodson	Asa Light MV	F37
MV1217-11	Strumenti per otturazioni plastiche	Asa Light MV	F37
MV1218-6	Strumenti per otturazioni plastiche	Asa Light MV	F37
MV1219-179	Strumenti per otturazioni plastiche	Asa Light MV	F37
MV1220-B2	Otturatori - Brunitori	Asa Light MV	F34
MV1221-31	Otturatori - Brunitori	Asa Light MV	F34
MV1230-1	Compattatori per osso		E35
MV1230-2	Compattatori per osso		E35
MV1231-1	Applicatori per osso	Asa Light MV	E29
MV1301	Applicatori per sottofondo	Asa Light MV	F41
MV1302	Applicatori per sottofondo	Asa Light MV	F41
MV1400-1	Otturatori per amalgama - Markley	Asa Light MV	F32
MV1400-2	Otturatori per amalgama - Markley	Asa Light MV	F32
MV1400-3	Otturatori per amalgama - Markley	Asa Light MV	F32
MV1400-4	Otturatori per amalgama - Markley	Asa Light MV	F32
MV1400-5	Otturatori per amalgama - Markley	Asa Light MV	F32
MV1400-6	Otturatori per amalgama - Markley	Asa Light MV	F32
MV1500-02	Strumenti per modellare amalgama/cera - Hollenback	Asa Light MV	F38, L13
MV1500-3	Strumenti per modellare amalgama/cera - Hollenback	Asa Light MV	F38, L13
MV1500-3S	Strumenti per modellare amalgama/cera - Hollenback	Asa Light MV	F38, L13
MV1501-1	Strumenti per modellare amalgama/cera - Ward	Asa Light MV	F38, L13
MV1501-1S	Strumenti per modellare amalgama/cera - Ward	Asa Light MV	F38, L13
MV1501-2	Strumenti per modellare amalgama/cera - Ward	Asa Light MV	F38, L13
MV1502-1	Strumenti per modellare amalgama/cera - Frahm	Asa Light MV	F39, L13
MV1507-8	Strumenti per modellare	Asa Light MV	F39
MV1600-1	Strumenti per modellare - cleoide-discoide	Asa Light MV	F40
MV1600-2	Strumenti per modellare - cleoide-discoide	Asa Light MV	F40
MV1600-3	Strumenti per modellare - cleoide-discoide	Asa Light MV	F40
MV1600-4	Strumenti per modellare - cleoide-discoide	Asa Light MV	F40
MV1601-1	Strumenti per preparazione cavità - finitori per bordi gengivali - distale - Black/26	Asa Light MV	F21

CODICE	DESCRIZIONE	MANICO	PAGINA
MV1601-2	Strumenti per preparazione cavità - finitori per bordi gengivali - mesiale - Black/27	Asa Light MV	F21
MV1601-3	Strumenti per preparazione cavità - finitori per bordi gengivali - distale - Black/28	Asa Light MV	F21
MV1601-4	Strumenti per preparazione cavità - finitori per bordi gengivali - mesiale - Black/29	Asa Light MV	F21
MV1602-1	Strumenti per preparazione cavità - finitori per bordi gengivali - distale - Black/77-78	Asa Light MV	F21
MV1602-2	Strumenti per preparazione cavità - finitori per bordi gengivali - mesiale - Black/79-80	Asa Light MV	F21
MV1603-1	Strumenti per preparazione cavità - scalpelli - Black/53-54	Asa Light MV	F22
MV1603-2	Strumenti per preparazione cavità - scalpelli - Black/51-52	Asa Light MV	F22
MV1604-02	Strumenti per preparazione cavità - scalpelli - Wedelstaedt	Asa Light MV	F22
MV1604-04	Strumenti per preparazione cavità - scalpelli - Wedelstaedt	Asa Light MV	F22
MV1604-06	Strumenti per preparazione cavità - scalpelli - Wedelstaedt	Asa Light MV	F22
MV1700-0	Escavatori - cucchiali	Asa Light MV	F16
MV1700-1	Escavatori - cucchiali	Asa Light MV	F16
MV1700-2	Escavatori - cucchiali	Asa Light MV	F16
MV1700-3	Escavatori - cucchiali	Asa Light MV	F16
MV1700-4	Escavatori - cucchiali	Asa Light MV	F16
MV1701-1	Escavatori - cucchiali	Asa Light MV	F16
MV1701-2	Escavatori - cucchiali	Asa Light MV	F16
MV1702-6	Escavatori - cucchiali	Asa Light MV	F17
MV1703-14	Escavatori - cucchiali	Asa Light MV	F17
MV1704-17	Escavatori - cucchiali	Asa Light MV	F17
MV1704-17W	Escavatori - cucchiali ovali	Asa Light MV	F18
MV1705-18	Escavatori - cucchiali	Asa Light MV	F17
MV1705-18W	Escavatori - cucchiali ovali	Asa Light MV	F18
MV1706-19	Escavatori - cucchiali	Asa Light MV	F17
MV1706-19W	Escavatori - cucchiali ovali	Asa Light MV	F18
MV1707-39	Escavatori - cucchiali	Asa Light MV	F17
MV1709-31L	Escavatori - cucchiali	Asa Light MV	B15, F17
MV1709-32L	Escavatori - cucchiali	Asa Light MV	B15, F17
MV1709-33L	Escavatori - cucchiali	Asa Light MV	B15, F17
MV1801-D	Scalpelli chirurgici - TG	Asa Light MV	H26
MV1802-3	Scalpelli chirurgici - Ochsenbein	Asa Light MV	H26
MV1802-4	Scalpelli chirurgici - Ochsenbein	Asa Light MV	H26
MV1803-D	Bisturi per gengivectomia - Kirkland	Asa Light MV	H24
MV1804-D	Bisturi per gengivectomia - Orban	Asa Light MV	H24
MV1805-02	Curette e Scaler - Langer	Asa Light MV	H5
MV1805-04	Curette e Scaler - Langer	Asa Light MV	H5
MV1806-02	Curette e Scaler	Asa Light MV	H4
MV1806-2RL	Curette e Scaler - Columbia	Asa Light MV	H4
MV1806-4RL	Curette e Scaler - Columbia	Asa Light MV	H4
MV1806-14	Curette e Scaler - Columbia	Asa Light MV	H4
MV1806-412	Curette e Scaler - Columbia	Asa Light MV	H4
MV1806-414	Curette e Scaler - Columbia	Asa Light MV	H4
MV1807-02	Curette Gracey	Asa Light MV	H11
MV1807-04	Curette Gracey	Asa Light MV	H11
MV1807-06	Curette Gracey	Asa Light MV	H11
MV1807-08	Curette Gracey	Asa Light MV	H11
MV1807-10	Curette Gracey	Asa Light MV	H11
MV1807-11MD	Curette Gracey	Asa Light MV	H11
MV1807-12	Curette Gracey	Asa Light MV	H11
MV1807-13MD	Curette Gracey	Asa Light MV	H11
MV1807-14	Curette Gracey	Asa Light MV	H11
MV1809-1	Curette e Scaler - Goldman-Fox	Asa Light MV	H6
MV1809-2	Curette e Scaler - Goldman-Fox	Asa Light MV	H6
MV1809-3	Curette e Scaler - Goldman-Fox	Asa Light MV	H6
MV1809-4	Curette e Scaler - Goldman-Fox	Asa Light MV	H6
MV1809-5	Curette e Scaler - Goldman-Fox	Asa Light MV	H6
MV1809-6	Curette e Scaler - Goldman-Fox	Asa Light MV	H6
MV1809-21	Curette e Scaler - Goldman-Fox	Asa Light MV	H6
MV1810-07	Lime - Hirschfeld	Asa Light MV	H22
MV1811-37	Chisels - back-action - Rhodes	Asa Light MV	H26
MV1812-02S	Lime - Sugarman	Asa Light MV	H22
MV1812-04S	Lime - Sugarman	Asa Light MV	H22
MV1813-10	Lime - Schluger	Asa Light MV	H22
MV1824-14	Curette e Scaler - anteriore - Indiana University	Asa Light MV	H5
MV1824-18	Curette e Scaler - posteriore - Indiana University	Asa Light MV	H5

CODICE	DESCRIZIONE	MANICO	PAGINA
MV1825-12	Curette e Scaler · Mc Call	Asa Light MV	H7
MV1825-14	Curette e Scaler · Mc Call	Asa Light MV	H7
MV1825-14S	Curette e Scaler · Mc Call	Asa Light MV	H7
MV1825-18S	Curette e Scaler · Mc Call	Asa Light MV	H7
MV1825-20	Curette e Scaler · Mc Call	Asa Light MV	H7
MV1826-T03	Curette e Scaler · Taylor	Asa Light MV	H8
MV1827-204S	Curette e Scaler	Asa Light MV	H8
MV1829-CK6	Curette e Scaler · Crane-Kaplan	Asa Light MV	H8
MV1830-YG08	Curette e Scaler · Younger-Good	Asa Light MV	H8
MV1831-32	Curette e Scaler · Jacquette	Asa Light MV	H9
MV1831-33	Curette e Scaler · Jacquette	Asa Light MV	H9
MV1831-35	Curette e Scaler · Jacquette	Asa Light MV	H9
MV1831-38	Curette e Scaler · Jacquette	Asa Light MV	H9
MV1850-9A	Scollaperiostio ed Elevatori · Allen	Asa Light MV	E23, H16
MV1850-GF	Scollaperiostio ed Elevatori · GF Goldman-Fox	Asa Light MV	E22, H16
MV1850-M7	Scollaperiostio ed Elevatori · Molt	Asa Light MV	E23, H16
MV1850-M8	Scollaperiostio ed Elevatori · Molt	Asa Light MV	E23, H16
MV1850-M9	Scollaperiostio ed Elevatori · Molt	Asa Light MV	E23, H16
MV1851-2	Scollaperiostio ed Elevatori · Hourigan	Asa Light MV	E23, H16
MV1851-PR3	Scollaperiostio ed Elevatori · Prichard	Asa Light MV	E23, H16
MV1852-1	Scollaperiostio ed Elevatori · Hopkins	Asa Light MV	E24, H17
MV1852-2	Scollaperiostio ed Elevatori · Hopkins	Asa Light MV	E24, H17
MV1853-15	Scollaperiostio ed Elevatori · Freer	Asa Light MV	E24, H17
MV1853-16	Scollaperiostio ed Elevatori · Freer	Asa Light MV	E24, H17
MV1854-3	Scollaperiostio ed Elevatori · Mead	Asa Light MV	E24, H17
MV1855-1	Strumenti per rialzo del seno mascellare	Asa Light MV	E15
MV1855-2	Strumenti per rialzo del seno mascellare	Asa Light MV	E15
MV1855-3	Strumenti per rialzo del seno mascellare	Asa Light MV	E15
MV1855-4	Strumenti per rialzo del seno mascellare	Asa Light MV	E15
MV1855-5	Strumenti per rialzo del seno mascellare	Asa Light MV	E15
MV1855-6	Strumenti per rialzo del seno mascellare	Asa Light MV	E15
MV1856-1	Strumenti per rialzo del seno mascellare	Asa Light MV	E13
MV1856-2	Strumenti per rialzo del seno mascellare	Asa Light MV	E13
MV1856-3	Strumenti per rialzo del seno mascellare	Asa Light MV	E13
MV1856-4	Strumenti per rialzo del seno mascellare	Asa Light MV	E13
MV1856-5	Strumenti per rialzo del seno mascellare	Asa Light MV	E13
MV1856-6	Strumenti per rialzo del seno mascellare	Asa Light MV	E14
MV1856-7	Strumenti per rialzo del seno mascellare	Asa Light MV	E14
MV1856-8	Strumenti per rialzo del seno mascellare	Asa Light MV	E14
MV1883	Posizionatori di membrane · Buser	Asa Light MV	E31
MV1902-1	Scaler · Towner Jacquette	Asa Light MV	H14
MV1902-2	Scaler · Towner Jacquette	Asa Light MV	H14
MV1904-H5	Scaler	Asa Light MV	H14
MV1904-H6	Scaler	Asa Light MV	H14
MV1905-02	Scaler	Asa Light MV	H14
MV2000-1	Cucchiai alveolari · Hemingway	Leonardo ML	C45, E21, H20
MV2000-2	Cucchiai alveolari · Hemingway	Asa Light MV	C45, E21, H20
MV2000-3	Cucchiai alveolari · Hemingway	Asa Light MV	C45, E21, H20
MV2000-4	Cucchiai alveolari · Hemingway	Asa Light MV	H20
MV2001-85	Cucchiai alveolari · Lucas	Asa Light MV	H20
MV2001-86	Cucchiai alveolari · Lucas	Asa Light MV	H20
MV2001-87	Cucchiai alveolari · Lucas	Asa Light MV	H20
MV2001-88	Cucchiai alveolari · Lucas	Asa Light MV	H20
MV2002-1	Lime per alveolotomia · Wahl	Asa Light MV	H23
MV2002-2	Lime per alveolotomia · Wahl	Asa Light MV	H23
PR0460-15TC	Porta aghi · punte curve · Castroviejo TC		C18, E6
PR0625-2	Pinzette per sutura		C40, E36
PR0625-3	Pinzette per sutura		C40, E36
PR0632-1	Pinzette chirurgiche · Cooley		C38
PR1801-1	Scalpellini e sgorbie per parodontologia	Perfection	H27
PR1850-1	Scollaperiostio ed Elevatori	Perfection	E24, H18
PR1850-M	Dissettori · Buser	Perfection	E22, H16
PR1857-1	Dissettori	Perfection	D70, E22
PR1859-1	Strumenti per rialzo del seno mascellare	Perfection	E14
PR1859-2	Strumenti per rialzo del seno mascellare	Perfection	E14

CODICE	DESCRIZIONE	MANICO	PAGINA
RC0700-6	Sonde singole	AsaWave RC	B6
RC0700-9	Sonde singole	AsaWave RC	B6
RC0700-23	Sonde singole	AsaWave RC	B6
RC0702-12	Sonde millimetriche parodontali	AsaWave RC	E32, H3
RC0703-14	Sonde millimetriche parodontali	AsaWave RC	H3
RC0704-23D1	Sonde doppie	AsaWave RC	B8
RC0707-GFW	Combinazioni Sonde - Sonde millimetriche · Goldman-Fox Williams	AsaWave RC	B11
RC0803-1	Otturatori per canali · Machtou	AsaWave RC	B13, G5
RC0803-2	Otturatori per canali · Machtou	AsaWave RC	B13, G5
RC0803-3	Otturatori per canali · Machtou	AsaWave RC	B13, G5
RC0803-4	Otturatori per canali · Machtou	AsaWave RC	B13, G5
RC1102-1	Spatole Heidemann	AsaWave RC	F27
RC1102-2	Spatole Heidemann	AsaWave RC	F27
RC1102-3	Spatole Heidemann	AsaWave RC	F27
RC1200-2	Otturatori per amalgama	AsaWave RC	F29
RC1200-3	Otturatori per amalgama	AsaWave RC	F29
RC1200-4	Otturatori per amalgama	AsaWave RC	F29
RC1200-5	Otturatori per amalgama	AsaWave RC	F29
RC1202-2	Otturatori per amalgama	AsaWave RC	F30
RC1210-1	Strumenti per otturazioni plastiche	AsaWave RC	F37
RC1210-2	Strumenti per otturazioni plastiche	AsaWave RC	F37
RC1210-3	Strumenti per otturazioni plastiche	AsaWave RC	F37
RC1215-18	Otturatori - Brunitori · Ball	AsaWave RC	F34
RC1215-27S	Otturatori - Brunitori	AsaWave RC	F34
RC1510-1D	Strumenti per composito	AsaWave RC	F52
RC1510-2D	Strumenti per composito	AsaWave RC	F52
RC1510-3D	Strumenti per composito	AsaWave RC	F52
RC1510-4D	Strumenti per composito	AsaWave RC	F52
RC1510-5D	Strumenti per composito	AsaWave RC	F52
RC1700-1	Escavatori - cucchiali	AsaWave RC	F16
RC1700-2	Escavatori - cucchiali	AsaWave RC	F16
RC1700-3	Escavatori - cucchiali	AsaWave RC	F16
RC1806-14	Curette e Scaler · Columbia	AsaWave RC	H4
RC1806-14SF	Curette e Scaler · Columbia · Sharpen Free	AsaWave RC	H4
RC1807-02	Curette Gracey	AsaWave RC	H11
RC1807-02SF	Curette Gracey · Sharpen Free	AsaWave RC	H11
RC1807-04	Curette Gracey	AsaWave RC	H11
RC1807-04SF	Curette Gracey · Sharpen Free	AsaWave RC	H11
RC1807-06	Curette Gracey	AsaWave RC	H11
RC1807-06SF	Curette Gracey · Sharpen Free	AsaWave RC	H11
RC1807-08	Curette Gracey	AsaWave RC	H11
RC1807-08SF	Curette Gracey · Sharpen Free	AsaWave RC	H11
RC1807-10	Curette Gracey	AsaWave RC	H11
RC1807-10SF	Curette Gracey · Sharpen Free	AsaWave RC	H11
RC1807-12	Curette Gracey	AsaWave RC	H11
RC1807-12SF	Curette Gracey · Sharpen Free	AsaWave RC	H11
RC1807-14	Curette Gracey	AsaWave RC	H11
RC1807-14SF	Curette Gracey · Sharpen Free	AsaWave RC	H11
RC1807-16	Curette Gracey	AsaWave RC	H11
RC1807-16SF	Curette Gracey · Sharpen Free	AsaWave RC	H11
RC1807-18	Curette Gracey	AsaWave RC	H11
RC1807-18SF	Curette Gracey · Sharpen Free	AsaWave RC	H11
RC1825-14	Curette e Scaler · Mc Call	AsaWave RC	H7
RC1825-14S	Curette e Scaler · Mc Call	AsaWave RC	H7
RC1825-14SF	Curette e Scaler · Mc Call · Sharpen Free	AsaWave RC	H7
RC1825-14SSF	Curette e Scaler · Mc Call · Sharpen Free	AsaWave RC	H7
RC1827-204S	Curette e Scaler	AsaWave RC	H8
RC1827-204SSF	Curette e Scaler · Sharpen Free	AsaWave RC	H8
RC1829-CK6	Curette e Scaler · Crane-Kaplan	AsaWave RC	H8
RC1829-CK6S	Curette e Scaler · Mini Crane-Kaplan	AsaWave RC	H8
RC1829-CK6SF	Curette e Scaler · Crane-Kaplan · Sharpen Free	AsaWave RC	H8
RC1829-CK6SSF	Curette e Scaler · Mini Crane-Kaplan · Sharpen Free	AsaWave RC	H8
RC1900-M23	Scaler · Universal Scaler	AsaWave RC	H14
RC1900-M23SF	Scaler · Universal Scaler · Sharpen Free	AsaWave RC	H14
RC1902-1	Scaler · Towner Jacquette	AsaWave RC	H14

CODICE	DESCRIZIONE	MANICO	PAGINA
RC1902-2	Scaler - Townner Jacquette	AsaWave RC	H14
RC1902-1SF	Scaler - Townner Jacquette - Sharpen Free	AsaWave RC	H14
RC1902-2SF	Scaler - Townner Jacquette - Sharpen Free	AsaWave RC	H14
RC1904-H5	Scaler	AsaWave RC	H14
RC1904-H5SF	Scaler - Sharpen Free	AsaWave RC	H14
RC1904-H6	Scaler	AsaWave RC	H14
RC1904-H6SF	Scaler - Sharpen Free	AsaWave RC	H14
RC2001-85	Cucchiai alveolari - Lucas	AsaWave RC	H20
RC2001-86	Cucchiai alveolari - Lucas	AsaWave RC	H20
RC2001-87	Cucchiai alveolari - Lucas	AsaWave RC	H20
RC2001-88	Cucchiai alveolari - Lucas	AsaWave RC	H20
RC2101	Manici per specchietti	AsaWave RC	B19
S0100-1	Pinze per estrazione		D4
S0100-2	Pinze per estrazione		D5
S0100-3	Kit per chirurgia orale ed estrattiva		D72
S0100-4	Kit per chirurgia orale ed estrattiva		D72
S0110	Pinze per estrazione per bambini		D38
S0112	Pinze per estrazione per bambini - Klein		D39
S0200-6	Leve per radici		D49
S0200-10	Leve per radici		D51
S0244-6	Leve per radici		D52
S0280-4	Ideal - Kit di 4 leve		D47
S0296-1	Kit di Sindesmotomi		D71
S0296	Kit di Sindesmotomi		D71
S0352	Kit composto da pinza toglilame e manico per bisturi		C24, E9
S0495-6	Osteotomi		E19
S0498-8	Strumenti per chirurgia implantare - kit mini rialzo del seno		E40
S0600-1	Kit prima visita parodontale		H36
S0600-6	Kit strumenti prima visita		B22
S0600-9	Kit strumenti prima visita		B22
S0600-23	Kit strumenti prima visita		B22
S0601-1	Pinzette per medicazioni - Flagg		B4
S0601-2	Pinzette per medicazioni - London-College		B4
S0601-3	Pinzette per medicazioni - Meriam		B4
S0645	Set di pinzette chirurgiche		C42
S0690-2	Divaricatore ultralight		B21
S0700-6	Sonde singole		B7
S0700-9	Sonde singole		B7
S0700-11	Sonde singole		B7
S0700-16	Sonde singole		B7
S0700-23	Sonde singole		B7
S0702L-7	Kit per endodonzia - serie di 7 strumenti Laser System		B24
S0702L-23	Kit per endodonzia - università di Boston		B25
S0800	Kit per endodonzia		B24
S0903-1	Spatole per cemento		F25
S0903-2	Spatole per cemento		F25
S0903-3	Spatole per cemento		F25
S1102-1	Spatole Heidemann		F27
S1102-2	Spatole Heidemann		F27
S1102-3	Spatole Heidemann		F27
S1200-1	Otturatori per amalgama		F29
S1200-2	Otturatori per amalgama		F29
S1200-3	Otturatori per amalgama		F29
S1200-4	Otturatori per amalgama		F29
S1200-5	Otturatori per amalgama		F29
S1200T	Otturatori per amalgama		F28
S1222-7	Strumenti per composito		F53
S1222-15	Strumenti per composito		F53
S1400	Otturatori per amalgama - Markley		F32
S1700-0	Escavatori - cucchiai		F16
S1700-1	Escavatori - cucchiai		F16
S1700-2	Escavatori - cucchiai		F16
S1700-3	Escavatori - cucchiai		F16
S1700-4	Escavatori - cucchiai		F16
S1700	Escavatori - cucchiai		F16

CODICE	DESCRIZIONE	MANICO	PAGINA
S1710-6	Escavatori - SS. White		F19
S1800-23	Kit di strumenti per parodontologia		H37
S1806	Curette e Scaler		H4
S1807-3	Curette Gracey		H34
S1807	Curette Gracey		H34
S1807AF-3	Curette Gracey		H34
S1807AF	Curette Gracey		H34
S1807MF-3	Curette Gracey		H34
S1807MF	Curette Gracey		H34
S1809	Curette e Scaler		H6
S1890	Pietre per affilare		H33
S1899	Kit di strumenti per parodontologia		H35
S2002-6	Specchietto parallelizzatore con manico	Asa60	B19
S2100	Manici per specchietti - serie da 5 pz		B19
S2101	Manici per specchietti - serie da 5 pz		B19
S2102-IN	Manici per specchietti - serie da 5 pz, vuoti		B19
S2700	Vassoi portastrumenti in acciaio inox - per 7 strumenti		J6
S2702	Vassoi portastrumenti in acciaio inox - per 7 strumenti		J6
S2720-1	Vassoi portastrumenti in acciaio inox - per 16 strumenti		J5
S2720-2	Vassoi portastrumenti in acciaio inox - per 23 strumenti		J5
S2721-1	Vassoi portastrumenti in acciaio inox - per 16 strumenti		J4
S2721-2	Vassoi portastrumenti in acciaio inox - per 23 strumenti		J4
S2722-1	Vassoi portastrumenti in acciaio inox - per 16 strumenti		J4
S2722-2	Vassoi portastrumenti in acciaio inox - per 23 strumenti		J4
S2723-1	Vassoi portastrumenti in acciaio inox - per 8 strumenti		J6
S2723-2	Vassoi portastrumenti in acciaio inox - per 4 strumenti		J6
S2724-1	Vassoi portastrumenti in acciaio inox - per 8 strumenti		J7
S2724-2	Vassoi portastrumenti in acciaio inox - per 4 strumenti		J7
S2731-1	Vassoio porta uncini in acciaio inox completo di 8 uncini		F14
S2731-12	Vassoio porta uncini in acciaio inox completo di 12 uncini		F14
S2760-A	Porta frese in silicone colorato - Arancio		E34, J19
S2760-C	Porta frese in silicone colorato - Blu		E34, J19
S2780-IMP	Strumenti per chirurgia implantare		E39
S2800-12	Portaimpronta forati in alluminio		K38
S2801-6	Portaimpronta forati in acciaio inox		K12
S2801-8	Portaimpronta forati in acciaio inox		K12
S2801-12	Portaimpronta forati in acciaio inox		K12
S2801A-6	Portaimpronta forati in acciaio inox - anatomic		K14
S2801A-8	Portaimpronta forati in acciaio inox - anatomic		K14
S2801A-12	Portaimpronta forati in acciaio inox - anatomic		K14
S2802-6	Portaimpronta non forati in acciaio inox		K34
S2802-8	Portaimpronta non forati in acciaio inox		K34
S2802-12	Portaimpronta non forati in acciaio inox		K34
S2802A-6	Portaimpronta non forati in acciaio inox - anatomic		K36
S2802A-8	Portaimpronta non forati in acciaio inox - anatomic		K36
S2802A-12	Portaimpronta non forati in acciaio inox - anatomic		K36
S2803-10	Portaimpronta non forati in acciaio inox - NEW SUPER		K22
S2803S-10	Portaimpronta non forati in acciaio inox - NEW SUPER high grip		K32
S2804-6	Portaimpronta forati in acciaio inox - PERMA-LOCK		K4
S2804-8	Portaimpronta forati in acciaio inox - PERMA-LOCK		K4
S2804-12	Portaimpronta forati in acciaio inox - PERMA-LOCK		K4
S2804A-6	Portaimpronta forati in acciaio inox - PERMA-LOCK anatomic		K6
S2804A-8	Portaimpronta forati in acciaio inox - PERMA-LOCK anatomic		K6
S2804A-12	Portaimpronta forati in acciaio inox - PERMA-LOCK anatomic		K6
S2804S-6	Portaimpronta non forati in acciaio inox - PERMA-LOCK high grip		K8
S2804S-8	Portaimpronta non forati in acciaio inox - PERMA-LOCK high grip		K8
S2804S-12	Portaimpronta non forati in acciaio inox - PERMA-LOCK high grip		K8
S2806-8	Portaimpronta non forati in acciaio inox per edentuli		K11
S2807-6	Portaimpronta non forati in acciaio inox - PERMA-LOCK		K24
S2807-8	Portaimpronta non forati in acciaio inox - PERMA-LOCK		K24
S2807-12	Portaimpronta non forati in acciaio inox - PERMA-LOCK		K24
S2807A-6	Portaimpronta non forati in acciaio inox - PERMA-LOCK anatomic		K26
S2807A-8	Portaimpronta non forati in acciaio inox - PERMA-LOCK anatomic		K26
S2807A-12	Portaimpronta non forati in acciaio inox - PERMA-LOCK anatomic		K26
S2807S-6	Portaimpronta non forati in acciaio inox - PERMA-LOCK high grip		K28

CODICE	DESCRIZIONE	MANICO	PAGINA
S28075-8	Portaimpronta non forati in acciaio inox - PERMA-LOCK high grip		K28
S28075-12	Portaimpronta non forati in acciaio inox - PERMA-LOCK high grip		K28
S2808-8	Portaimpronta non forati in acciaio inox per edentuli		K31
S2809-6	Portaimpronta forati in acciaio inox - depressi anteriormente		K10
S2810-6	Portaimpronta non forati in acciaio inox - depressi anteriormente		K30
S2811-1	Portaimpronta forati in acciaio inox · Ehrlicke		K16
S2811-2	Portaimpronta forati in acciaio inox · Ehrlicke		K16
S2811-3	Portaimpronta forati in acciaio inox · Ehrlicke		K18
S2811-4	Portaimpronta forati in acciaio inox · Ehrlicke		K19
S2813	Portaimpronta forati in acciaio inox per edentuli		K20
S2816-6	Portaimpronta forati in alluminio - ORTHOBABY per bambini		K42
S2851-24	Portaimpronta in policarbonato per edentuli		K48
S2880-12	Portaimpronta forati in alluminio per implantologia		K40
S2880-12FR	Portaimpronta forati in alluminio per implantologia		K40
S3000	Kit di strumenti per diga		F13
S3001-20	Strumenti per chirurgia implantare · Goracci kit		E40
S3002-13	Kit di strumenti per chirurgia orale		C46
S3002-17	Kit di strumenti per chirurgia orale		C46
S3002-18	Kit di strumenti per chirurgia orale		C47
S3003-9	Strumenti per chirurgia implantare		E41, H36
S3003-11	Strumenti per chirurgia implantare		E41, H37
S5112	Strumenti per modellare amalgama/cera		L17
S512AL	Strumenti per modellare amalgama/cera		L17
S5160	Strumenti per cera con punte intercambiabili		L18
S5160-1C	Strumenti per cera con punte intercambiabili	Alu80	L18
S5160-2C	Strumenti per cera con punte intercambiabili	Alu80	L18
S5160-3C	Strumenti per cera con punte intercambiabili	Alu80	L18
S5800	Vassoio porta pinze		J14
S6810-1	"Lab Set" per Odontotecnica		L35
S6810-2	"Lab Set" per Odontotecnica		L35
S6811-2	"Lab Set" per Odontotecnica		L34
SLV1807	Curette Gracey		H34
SLV1807AF	Curette Gracey		H34
SLV1807MF	Curette Gracey		H34
SML1710-6	Escavatori · SS. White		F19
SML1807	Curette Gracey		H34
SML1807AF	Curette Gracey		H34
SML1807MF	Curette Gracey		H34
SML2021CF	Apical micro endo kit Full		G12
SML2021FP	Apical micro endo kit Essential		G8
SMV1400	Otturatori per amalgama · Markley		F32
SMV1700	Escavatori - cucchiari		F16
SMV1806	Curette e Scaler		H4
SMV1807	Curette Gracey		H34
SMV1809	Curette e Scaler		H6
SPR0495	Strumenti per chirurgia implantare · Kit mini rialzo del seno		E39
SPR0496	Strumenti per chirurgia implantare · Kit grande rialzo del seno		E38
SPR2781-I	Kit chirurgia implantare		E38
SPR2781-P	Kit chirurgia parodontale		H36
SPR2781-S	Kit chirurgia orale		D72
SRC0600-6	Kit strumenti prima visita - AsaWave	AsaWave RC	B23
SRC0600-9	Kit strumenti prima visita - AsaWave	AsaWave RC	B23
SRC0600-23	Kit strumenti prima visita - AsaWave	AsaWave RC	B23
SRC1807	Curette Gracey	AsaWave RC	H34
SVS2731-6	Vision® Shade · vassoio magnetico in acciaio inox con 6 uncini		F3
SVS3000	Vision® Shade kit		F5
SWML0600-6	Kit strumenti prima visita - AsaLady		B22
SWML0600-9	Kit strumenti prima visita - AsaLady		B22
SWML0600-23	Kit strumenti prima visita - AsaLady		B22
VS3045	Vision® Shade · confezione di 60 dighe di gomma (colore nero, profumo menta)		F3
VS3051-210	Vision® Shade · uncino con alette		F4
VS3052-2	Vision® Shade · uncino con alette		F4
VS3052-12A	Vision® Shade · uncino dentellato con alette		F4
VS3052-13A	Vision® Shade · uncino dentellato con alette		F4
VS3052-W4	Vision® Shade · uncino senza alette		F4

CODICE	DESCRIZIONE	MANICO	PAGINA
VS3052-W8	Vision® Shade · uncino senza alette		F4
VV2731-6	Vision® Shade · vassoio magnetico in acciaio inox senza uncini		F3
VV3030	Vision® Shade · pinze per uncini in acciaio inox		F4
VV3033	Vision® Shade · pinza foradiga in acciaio inox		F4
VV3035	Vision® Shade · dima di foratura in acciaio inox		F5
VV3040-2	Vision® Shade · telaio per diga in acciaio inox 100x150 mm		F3
VVPEN	Vision® Shade · pennarello per uso alimentare		F5
W0121-5	Pinze per estrazione forma americana - AsaLady · Physick		D29
W0121-6	Pinze per estrazione forma americana - AsaLady		D29
W0121-10S	Pinze per estrazione forma americana - AsaLady		D29
W0121-16	Pinze per estrazione forma americana - AsaLady		D29
W0121-17	Pinze per estrazione forma americana - AsaLady		D29
W0121-18L	Pinze per estrazione forma americana - AsaLady · Harris		D30
W0121-18R	Pinze per estrazione forma americana - AsaLady · Harris		D30
W0121-23	Pinze per estrazione forma americana - AsaLady		D30
W0121-53L	Pinze per estrazione forma americana - AsaLady		D30
W0121-53R	Pinze per estrazione forma americana - AsaLady		D30
W0121-65	Pinze per estrazione forma americana - AsaLady		D31
W0121-69	Pinze per estrazione forma americana - AsaLady · Tomes		D31
W0121-88L	Pinze per estrazione forma americana - AsaLady · Nevius		D31
W0121-88R	Pinze per estrazione forma americana - AsaLady · Nevius		D31
W0121-101	Pinze per estrazione forma americana - AsaLady · Hull		D31
W0121-150	Pinze per estrazione forma americana - AsaLady · Cryer		D32
W0121-150S	Pinze per estrazione forma americana - AsaLady · Cryer		D32
W0121-151	Pinze per estrazione forma americana - AsaLady · Cryer		D32
W0121-151S	Pinze per estrazione forma americana - AsaLady · Cryer		D32
W0121-222	Pinze per estrazione forma americana - AsaLady		D32
W0160-1	Pinze per estrazione - AsaLady		D21
W0160-2	Pinze per estrazione - AsaLady		D21
W0160-4	Pinze per estrazione - AsaLady		D21
W0160-7	Pinze per estrazione - AsaLady		D21
W0160-13	Pinze per estrazione - AsaLady		D21
W0160-17	Pinze per estrazione - AsaLady		D21
W0160-18	Pinze per estrazione - AsaLady		D21
W0160-21	Pinze per estrazione - AsaLady		D22
W0160-22	Pinze per estrazione - AsaLady		D22
W0160-33	Pinze per estrazione - AsaLady		D22
W0160-45	Pinze per estrazione - AsaLady		D22
W0160-51A	Pinze per estrazione - AsaLady		D22
W0160-67A	Pinze per estrazione - AsaLady		D22
W0160-74	Pinze per estrazione - AsaLady		D22
W0160-79	Pinze per estrazione - AsaLady		D23
W0160-86C	Pinze per estrazione - AsaLady		D23
W0160-145	Pinze per estrazione - AsaLady		D23
W0160-151/	Pinze per estrazione - AsaLady		D23
W0298-3	Sindesmotomi - AsaLady · Chompret		D67
W0319-1	Forbicine per gengive - AsaLady · rette		C3
W0319-2	Forbicine per gengive - AsaLady · curve		C3
W0349-3	Manici per bisturi - AsaLady		C26, E7
W0411-15	Porta aghi - AsaLady · Crile-Wood		C11
W0411-15TC	Porta aghi - AsaLady · Crile-Wood TC		C11
W0412-16	Porta aghi - AsaLady · Mayo-Hegar		C12
W0412-16TC	Porta aghi - AsaLady · Mayo-Hegar		C12
W0502-1	Pinze emostatiche - AsaLady · Halstead-Mosquito		C21
W0502-2	Pinze emostatiche - AsaLady · Halstead-Mosquito		C21
W0610-1	Pinzette per medicazioni - AsaLady · Flagg		B5
W0610-2	Pinzette per medicazioni - AsaLady · London College		B5
W0610-3	Pinzette per medicazioni - AsaLady · Meriam		B5
W3035	Pinze per uncini - AsaLady · Ivory lightweight		F12
W3036	Pinze per forare la diga - AsaLady · Ainsworth		F11
WML1102-1	Spatole Heidemann - AsaLady	Leonardo ML	F27
WML1102-2	Spatole Heidemann - AsaLady	Leonardo ML	F27
WML1102-3	Spatole Heidemann - AsaLady	Leonardo ML	F27
WML1401-0	Otturatori per amalgama · Foc	Leonardo ML	F33
WML1401-1	Otturatori per amalgama · Foc	Leonardo ML	F33

©2025 ASA DENTAL S.P.A.

In questo catalogo possono essere presenti errori tipografici, inesattezze o omissioni relative a caratteristiche di prodotto, specifiche tecniche, misure, quantità, configurazioni e altre informazioni.

Asa Dental non si assume alcuna responsabilità legale in merito all'accuratezza o alla completezza delle informazioni riportate, da intendersi unicamente come indicazioni generali.

Asa Dental si riserva il diritto di modificare, sostituire o eliminare prodotti senza preavviso al fine di migliorarne le caratteristiche tecniche o la qualità.

Consigliamo di consultare regolarmente il nostro sito web e di considerarlo la fonte attendibile di informazioni aggiornate in merito a disponibilità di prodotti, specifiche tecniche, procedure e istruzioni d'uso. In alternativa, suggeriamo di contattare il nostro servizio clienti.

L'uso di immagini, disegni e simboli disponibili in questo catalogo è soggetto ad approvazione da parte di Asa Dental e può essere utilizzato solo come supporto per materiale pubblicitario e promozionale dell'azienda e dei suoi prodotti.

Asa Dental, AsaOne, AsaLady, AsaFresh, AsaLight, Perfection, Vision, Leonardo, Leonardo Light, AsaWave, Asa Codicolor, Perma-Lock sono tutti marchi registrati di Asa Dental.

SEDE LEGALE

Asa Dental S.p.A.

Via Valenzana di Sopra, 60 - Bozzano
55054 Massarosa (Lu) - Italy
Tel. +39 0584 938305 - 93363 - 938306
Fax +39 0584 937167
asadental@asadental.it

CENTRO LOGISTICO

Via Sarzanese Valdera, 1331 - Bozzano
55054 Massarosa (Lu) - Italy

STABILIMENTI PRODUTTIVI

Via delle Piagge, 1/A - Marlia
55014 Capannori (Lu) - Italy

Via Fierla, 13 - Z.I.
33085 Maniago (Pn) - Italy

www.asadental.com

FILIALI

Asa Dental USA Corp.

105 Maxess Road, Suite 124
Melville, New York 11747 - USA

Asa Dental CHINA CO. LTD.

Room 315, Huaying Building,
Zhong Xin Avenue
Tianjin Airport Economic Area
Tianjin - China

Asa Dental S.p.A. (Branch)

Shahrazad Afdal Bahati Bldg.
Parcel 345-826
Bur Dubai
PO Box 414299
Dubai - UAE

